



**FOOTBALL**

***2022***  
***Football Rules Book***



IF

*i*

LOSE

I'LL RESPOND WITH RESPECT.

NCAA

**RESPECT.**

It's the name of the game.

Don't undo my hard work  
with poor sportsmanship.

IF YOU THINK YOU OR YOUR TEAMMATE HAS HAD A  
**CONCUSSION**

**DON'T HIDE IT. • REPORT IT. • TAKE TIME TO RECOVER.**



**IT'S BETTER TO MISS ONE GAME THAN THE WHOLE SEASON.**

**WHEN IN DOUBT, GET CHECKED OUT.**

For more information and resources, visit [www.CDC.gov/headsup](http://www.CDC.gov/headsup).



NCAA is a trademark of the National Collegiate Athletic Association.  
The mark "CDC" is licensed under authority of the PHS.

Reference to any commercial entity or product or service on this page should not be construed as an endorsement by the Government of the company or its products or services.



---

# **2022 NCAA® FOOTBALL RULES AND INTERPRETATIONS**

---

**NATIONAL COLLEGIATE ATHLETIC ASSOCIATION**





[ISSN 0736-5144]  
THE NATIONAL COLLEGIATE ATHLETIC ASSOCIATION  
P.O. BOX 6222  
INDIANAPOLIS, INDIANA 46206-6222  
317/917-6222  
[WWW.NCAA.ORG](http://WWW.NCAA.ORG)  
MAY 2022

**Manuscript Prepared By:** Steve Shaw, *Secretary-Rules Editor, NCAA Football Rules Committee.*

**Edited By:** Ty Halpin, *Director, Championships and Alliances.*

**Production By:** NCAA Staff

NCAA, NCAA LOGO AND NATIONAL COLLEGIATE ATHLETIC ASSOCIATION ARE REGISTERED MARKS OF THE ASSOCIATION AND USE IN ANY MANNER IS PROHIBITED UNLESS PRIOR APPROVAL IS OBTAINED FROM THE ASSOCIATION.

COPYRIGHT, 1974, BY THE NATIONAL COLLEGIATE ATHLETIC ASSOCIATION  
REPRINTED: 1975, 1976, 1977, 1978, 1979, 1980, 1981, 1982, 1983, 1984,  
1985, 1986, 1987, 1988, 1989, 1990, 1991, 1992, 1993, 1994, 1995, 1996,  
1997, 1998, 1999, 2000, 2001, 2002, 2003, 2004, 2005, 2006, 2007, 2008, 2009,  
2011, 2012, 2013, 2015, 2016, 2017, 2018, 2019, 2020, 2021, 2022  
PRINTED IN THE UNITED STATES OF AMERICA

---

# Contents

---

	<i>page</i>
NCAA Football Rules Committee.....	<a href="#">FR-4</a>
Major Rules Changes for 2022.....	<a href="#">FR-5</a>
Index to Editorial Changes.....	<a href="#">FR-6</a>
Points of Emphasis.....	<a href="#">FR-7</a>
Sportsmanship Statement.....	<a href="#">FR-10</a>
The Football Code.....	<a href="#">FR-11</a>
Official NCAA Football Rules.....	<a href="#">FR-13</a>
Rule 1—The Game, Field, Players and Equipment.....	<a href="#">FR-14</a>
Rule 2—Definitions.....	<a href="#">FR-28</a>
Rule 3—Periods, Time Factors and Substitutions.....	<a href="#">FR-47</a>
Rule 4—Ball in Play, Dead Ball, Out of Bounds.....	<a href="#">FR-61</a>
Rule 5—Series of Downs, Line to Gain.....	<a href="#">FR-64</a>
Rule 6—Kicks.....	<a href="#">FR-67</a>
Rule 7—Snapping and Passing the Ball.....	<a href="#">FR-76</a>
Rule 8—Scoring.....	<a href="#">FR-86</a>
Rule 9—Conduct of Players and Others Subject to the Rules.....	<a href="#">FR-92</a>
Rule 10—Penalty Enforcement.....	<a href="#">FR-108</a>
Rule 11—The Officials: Jurisdiction and Duties.....	<a href="#">FR-112</a>
Rule 12—Instant Replay.....	<a href="#">FR-113</a>
Appendix A—Guidelines for Serious On-Field Injuries.....	<a href="#">FR-121</a>
Appendix B—Lightning Policy.....	<a href="#">FR-122</a>
Appendix C—Concussions.....	<a href="#">FR-123</a>
Appendix D—Field Diagrams.....	<a href="#">FR-125</a>
Appendix E—Equipment: Additional Details.....	<a href="#">FR-132</a>
Appendix F—Official Football Signals.....	<a href="#">FR-138</a>
Appendix G—Summary of Penalties.....	<a href="#">FR-141</a>
Appendix H—Accommodations for Student-Athletes with Disabilities.....	<a href="#">FR-145</a>
Official NCAA Football Rules Interpretations.....	<a href="#">FI-1</a>
Table of Contents for Approved Rulings.....	<a href="#">FI-2</a>
List of New and Modified Approved Rulings.....	<a href="#">FI-3</a>
Rule 1—The Game, Field, Players and Equipment.....	<a href="#">FI-4</a>
Rule 2—Definitions.....	<a href="#">FI-8</a>
Rule 3—Periods, Time Factors and Substitutions.....	<a href="#">FI-12</a>
Rule 4—Ball in Play, Dead Ball, Out of Bounds.....	<a href="#">FI-24</a>
Rule 5—Series of Downs, Line to Gain.....	<a href="#">FI-27</a>
Rule 6—Kicks.....	<a href="#">FI-30</a>
Rule 7—Snapping and Passing the Ball.....	<a href="#">FI-41</a>
Rule 8—Scoring.....	<a href="#">FI-54</a>
Rule 9—Conduct of Players and Others Subject to the Rules.....	<a href="#">FI-62</a>
Rule 10—Penalty Enforcement.....	<a href="#">FI-78</a>
Index to Rules.....	<a href="#">IND-1</a>

---

# NCAA Football Rules Committee

---

The chart below lists the members of the committee who voted on and approved the rules included in this edition of the book. This information is being included for historical purposes.

Name	Institution	Term Expiration
Aaron Best	Eastern Washington University	9-1-24***
Bill Carollo	Big Ten Conference	9-1-22
Stan Hodgin	Shenandoah University	9-1-24
Jason Carmichael	University of West Georgia	9-1-25
Zac Selmon	University of Oklahoma	9-1-23
David Shaw*	Stanford University	9-1-22
Steve Shaw**	Secretary-Rules Editor	9-1-25***
Kirby Smart	University of Georgia	9-1-25
Rich Wanninger	Patriot League	9-1-25
John Wristen	Colorado State University, Pueblo	9-1-25
Doug Zipp	Ohio Wesleyan University	9-1-22
Bill Zwaan	West Chester University	9-1-22

\*Committee chair

\*\*Non-voting member

\*\*\*Eligible for reappointment

For a complete and current listing of the NCAA Football Rules Committee, please go to: [www.NCAA.org/playingrules](http://www.NCAA.org/playingrules).

Those who find it necessary to contact the editor for interpretations of rules, play situations or for information and guidance regarding officiating, may send an e-mail to the address below. Requests should be sent to:

**STEVE SHAW**

Secretary-Rules Editor

e-mail: [sdshaw.cfo@gmail.com](mailto:sdshaw.cfo@gmail.com)

---

# Major Rules Changes for 2022

---

The numbers and letters in the left column refer to rule, section and article, respectively. Changed or altered items are identified in the rules by a blue shaded background, unless the change results in the deletion of the entire segment containing the change.

This is a year in which playing rules changes are allowed. The 2023 season will be an “off-year” in the playing rules cycle; however, the committee is able to make changes for the following reasons during this period:

1) Student-athlete safety; 2) Adjustment to a rule change from the previous season that is not achieving its intent; or 3) Changes that have a significant impact on the image of the game.

The Football Rules Committee made the following major changes for the 2022 season:

## MAJOR RULES CHANGES for 2022

- |             |  |
|-------------|--|
| 3-3-5-b     | Feigning injury findings sent to conference office for further action.   |
| 4-1-3-r     | Ball declared dead when a ball carrier simulates or fakes a feet-first slide.  |
| 6-5-4       | Illegal block or contact by a player after a fair catch signal is now a 10-yard penalty.                               |
| 7-3-11      | Illegal touching penalty is five yards; now includes a loss of down.   |
| 9-1-3/9-1-4 | Appeal option added for a confirmed second-half targeting foul in games involving instant replay.                      |
| 9-1-6       | Blocking below the waist now restricted to inside the tackle box.  |
| 9-2-1-a-1   | Enhanced penalty options for Team B unsportsmanlike conduct fouls during pass plays added.                             |
| 9-3-4 (c-e) | Defensive holding penalties include a first down when accepted (this change eliminates previous 9-3-5 and 10-2-2-e-2). |



---

# Index to Editorial Changes

---

## SIGNIFICANT EDITORIAL CHANGES for 2022

- 1-4-5-a Allowing city and/or state of the institution in jersey design.
- 1-4-6-d Area allowed for insignia expanded by PROP.
- 1-4-11-b Coaches' booth space further clarified and codifying remote coaching prohibition.
- 2-27-14-a Defenseless player: Passer further defined.
- 3-2-4-c-6 Free kick play clock exception.
- 3-5-3-b Team B substitution approved ruling references added.
- 6-3-13 Clarifying the basic spot on fouls by kicking team.
- 6-5-1-b Clarifying possession after a fair catch signal.
- 7-2-5-b Dead-ball spot of a fumble at rest altered.
- 9-1 Pen. Added illegal blind-side block signal.
- 9-1-3 Crown of the helmet redefined.
- 9-1-4 Note 2 Defenseless player: Passer further defined.
- 9-1-15 Enhanced description of horse-collar tackle.
- 9-1-16-a-4 Expanded definition of when a kicker's protection ends.
- 9-1-16 Pen. Including holder in penalty description.
- 10-2-4 Clarifying the basic spot on fouls by kicking team.
- 12-3 Position of the ball in relation to the goal line reviewable.
- 12-3-2-f Location of the ball in relation to the goal line with grounding.
- 12-3-6-b Instant replay clock adjustment modified.
- 12-3-6-d-3 Restoring time at end of game clarified.
- 12-5-1-b-4 Coaches' challenge modified.
- 12-6-1-e O2O may be used to facilitate the review process.

## APPENDIX CHANGE for 2022

- Appendix F Addition of signal 28: Illegal blind-side block.

---

# Points of Emphasis

---

The NCAA Football Rules Committee has extraordinary pride in the Football Code, which was introduced in 1916 and has been updated several times. These guidelines form a harmony of agreement among coaches, players, game officials and administrators that places each contest in an environment of fairness and sportsmanship. It is noted that the Code emphasizes the following unethical practices: “Using the helmet as a weapon. The helmet is for protection of the player...” and “players and coaches should emphasize the elimination of targeting and initiating contact against a defenseless opponent and/or with the crown of the helmet.” Every participant in the collegiate football scene shares a responsibility for ethical conduct that enhances the future of this American tradition.

**PROTECTION OF DEFENSELESS PLAYERS / TARGETING**—The NCAA Football Rules Committee continues to embrace the targeting rule in order to promote player safety, reduce head contact and eliminate specific targeting actions from the game. The language in 9-1-3 and 9-1-4 stipulates that no player shall target and make forcible contact to the head or neck area of a defenseless player or contact an opponent with the crown (top) of their helmet. The definition of “crown of the helmet,” approved starting with the 2022 season, focuses the attention on the top of the helmet. The term “forcible contact” has replaced the word “initiate” to ensure the intent of the rule is clear.

These actions appear in two rules: Targeting and Making Forcible Contact With the Crown of the Helmet (Rule 9-1-3) and Targeting and Making Forcible Contact to Head or Neck Area of a Defenseless Player (Rule 9-1-4). Use of the helmet as a weapon and intentional (targeted) contact to the head or neck area are serious safety concerns. The penalties for fouls under both 9-1-3 and 9-1-4 include automatic disqualification. The committee continues to emphasize that coaches and officials must be diligent to insure that players understand and abide by these rules. A progressive penalty was added in 2019 to continue to emphasize adherence to this rule. Rule 2-27-14 defines and lists characteristics of a defenseless player.

An appeal process has been established starting with the 2022 season for players disqualified for targeting in the second half of a game. If the national coordinator concludes that it is clearly obvious the player should not have been disqualified, the conference may vacate the following game suspension.

**CONCUSSIONS**—Coaches and medical personnel should exercise caution in the treatment of a student-athlete who exhibits signs of a concussion. When in question, officials will declare an injury timeout for any player exhibiting signs of a concussion. See Appendix C for detailed information.

## **DISCONCERTING SIGNALS & PRE-SNAP ACTIONS**

The intent of pre-snap rules is to define and govern what is allowed by the offense and defense. The offense, by design, has an advantage of knowing the starting signal, cadence, or sound, and the defense has an advantage as they are not limited in terms of overall player movements before the snap. To discourage tactics at the line of scrimmage designed to cause an opponent to foul or to give either team an unmerited advantage, officials must be on high alert for any type of illegal pre-snap actions by either team. Additionally, coaches should not teach illegal pre-snap actions designed to make their opponent foul.

These actions can sometimes be difficult to observe or hear in our noisy stadiums; therefore, officials must be on high alert to stop these illegal actions. For the offense, focus should be on any movement by one or more players that simulate the start of a play. Special attention should be directed to the quarterback for action that includes any quick, jerky, or abrupt movement that simulates action at the snap.

On the defensive side of the ball, officials should pay special attention to sounds and actions that could create a disruption to the offense's starting signal or cause the offense to false start. This includes defenders near the line of scrimmage that make quick, abrupt, or exaggerated actions that are not part of normal defensive movement. The defense may move, but the movements may not simulate action at the snap. Additionally, the defense cannot use words or signals that simulate the sound or cadence of, or otherwise interfere with, the offensive starting signals. This includes using a clap on the defensive side of the ball that may disconcert the offense.

**FEIGNING AN INJURY**—With the advent of the up-tempo offenses, there is a growing trend of defensive players feigning an injury in an attempt to slow down or break the rhythm of the offense and try to gain an unwarranted time out. Full protection under the rules should go to a player that indeed suffers an injury; however, on occasion some potential injuries are suspect, happen in unusual windows between plays and appear to be staged. The Rules Committee had serious discussions on potential options on how to best take away incentive for players to feign an injury including adding additional time before a player could return from injury.

Head Coaches are expected to set a culture within their team to ensure that this type dishonest action will not be tolerated. Feigning an injury is not ethical and is completely against the spirit of fair competition. It is a bad look for our great game.

For the 2022 season, the Rules Committee has authorized an administrative process for questionable game action. An institution or conference has the option to consult the national coordinator of football officials who would then facilitate a video review. After the review, the national coordinator will communicate any findings to the conference office for further action.

Special attention is directed to the strongly-worded statement in The Football Code (coaching ethics, section g).

**UNSPORTSMANLIKE CONDUCT / TAUNTING**—Currently the Rules Committee is satisfied with the solid judgement that officials are demonstrating

evaluating celebration issues and this focus will continue. For the 2022 season, it will be a point of emphasis for officials to penalize any taunting action that is directed at an opponent. These actions are a bad look for the game and can lead to unnecessary confrontations between the teams and must be eliminated.

The pregame warm-up rules are designed to ensure proper sportsmanship before our contests. Officials should be vigilant during the pregame whenever players are on the field. Unsportsmanlike acts before the game are detrimental to the sport and must be cleaned up.

**SIDELINE CONTROL**—Coaches that need to have conversations with officials about specific rulings within the game must do so from the Team Area. Coaches are encouraged not to enter the field of play or leave the Team Area to debate officiating decisions, and those that do so will have committed an automatic Unsportsmanlike Conduct Foul.

Coaches will be allowed to only step to the sideline to call offensive and defensive signals after all action has ceased. That working space (six-foot white border) is intended to allow officials to adequately perform their duties; to protect the safety of officials, players and coaches; and to allow teams to demonstrate good sportsmanship within the team area. Special attention should be given to the rule stating that if a coach receives two unsportsmanlike fouls in a single game, they are ejected.

The NCAA Football Rules Committee and Division I Competition Committee has instructed officials to be more diligent in their observations of these actions and they are instructed to flag violations of the rule when it occurs in an area they can observe. Coaches are expected to set an appropriate, professional example for their players, fans and the many others who watch the game and to intervene when they see members of their team exhibit behavior that is not acceptable under the Sportsmanship guidelines of the Football Code.

**ILLEGAL CONTACT AGAINST A QUARTERBACK / PASSER**—Because of their position, the passer is often in a vulnerable position, with little or no opportunity to protect themselves from, or to prepare for, forcible contact. In recognition of this, there is an explicit rule (Rule 9-1-9) which addresses this unique situation: “No defensive player shall unnecessarily rough a passer when it is obvious the ball has been thrown.”

The rule then lists several specific acts which are illegal when they occur against a passer or potential passer. The NCAA Football Rules Committee over time has given options for the quarterback to protect himself, such as sliding feet first and to legally throw the ball away outside the tackle box. The definition of a defenseless player-passer has been expanded to include an offensive player in a passing posture with focus downfield. Because of the extremely vulnerable situation the quarterback position presents, it is important for all officials, and the Referee and the Center Judge in particular, to be a presence and recognize when a passer is threatened or is in a defenseless position. The crew must make it a priority to afford the quarterback all the protection the rules provide.



---

# Statement on Sportsmanship

---

## NCAA Football Rules Committee

- After reviewing a number of plays involving unsportsmanlike conduct, the committee is firm in its support of the unsportsmanlike conduct rules as they currently are written and officiated. Many of these fouls deal with players who taunt their opponent or inappropriately draw attention to themselves in a premeditated, excessive or prolonged manner. Players should be taught the discipline that reinforces football as a team game.
- The rules committee reminds head coaches of their responsibility for the behavior of their players before and after, as well as during, the game. Players must be cautioned against pre-game unsportsmanlike conduct on the field that can lead to confrontation between the teams. Such action can lead to penalties enforced on the opening kickoff, possibly including disqualification of players. Repeated occurrence of such unsportsmanlike behavior by a team may result in punitive action by the conference against the head coach and their institution.

---

# The Football Code

---

Football is an aggressive, rugged contact sport. Only the highest standards of sportsmanship and conduct are expected of players, coaches and others associated with the game. There is no place for unfair tactics, unsportsmanlike conduct or maneuvers deliberately designed to inflict injury.

The American Football Coaches Association (AFCA) Code of Ethics states:

- a. The Football Code shall be an integral part of this code of ethics and should be carefully read and observed.
- b. To gain an advantage by circumvention or disregard for the rules brands a coach or player as unfit to be associated with football.

Through the years, the rules committee has endeavored by rule and appropriate penalty to prohibit all forms of unnecessary roughness, unfair tactics and unsportsmanlike conduct. But rules alone cannot accomplish this end. Only the continued best efforts of coaches, players, officials and all friends of the game can preserve the high ethical standards that the public has a right to expect in America's foremost collegiate sport. Therefore, as a guide to players, coaches, officials and others responsible for the welfare of the game, the committee publishes the following code:

## Coaching Ethics

Deliberately teaching players to violate the rules is indefensible. The coaching of intentional holding, beating the ball, illegal shifting, feigning injury, interference, illegal forward passing or intentional roughing will break down rather than aid in the building of the character of players. Such instruction is not only unfair to one's opponent but is demoralizing to the players entrusted to a coach's care and has no place in a game that is an integral part of an educational program.

The following are unethical practices:

- a. Changing numbers during the game to deceive the opponent.
- b. Using the football helmet as a weapon. The helmet is for the protection of the player.
- c. Targeting and making forcible contact. Players, coaches and officials should emphasize the elimination of targeting and making forcible contact against a defenseless opponent and/or with the crown of the helmet.
- d. Using nontherapeutic drugs in the game of football. This is not in keeping with the aims and purposes of amateur athletics and is prohibited.
- e. "Beating the ball" by an unfair use of a starting signal. This is nothing less than deliberately stealing an advantage from the opponent. An honest starting signal is needed, but a signal that has for its purpose starting the team a fraction of a second before the ball is put in play, in the hope that it will not be detected by the officials, is illegal. It is the same as if a sprinter in a 100-meter dash had a secret arrangement

with the starter to give themselves a tenth-of-a-second warning before firing the pistol.

- f. Shifting in a way that simulates the start of a play or employing any other unfair tactic for the purpose of drawing one's opponent offside. This can be construed only as a deliberate attempt to gain an unmerited advantage.
- g. Feigning an injury for any reason is unethical. An injured player must be given full protection under the rules, but feigning injury is dishonest, unsportsmanlike and contrary to the spirit of the rules. Such tactics cannot be tolerated among sportsmen of integrity.

### **Talking to an Opponent**

Talking to an opponent in any manner that is demeaning, vulgar, abusive or "trashy" or intended to incite a physical response or verbally put an opponent down is illegal. Coaches are urged to discuss this conduct frequently and support all officials' actions to control it.

### **Talking to Officials**

When an official imposes a penalty or makes a decision, they are doing their duty as they see fit. Officials are on the field to uphold the integrity of the game of football, and their decisions are final and conclusive and should be accepted by players and coaches.

The AFCA Code of Ethics states:

- a. On- and off-the-record criticism of officials to players or to the public shall be considered unethical.
- b. For a coach to address, or permit anyone on their bench to address, uncomplimentary remarks to any official during the progress of a game, or to indulge in conduct that might incite players or spectators against the officials, is a violation of the rules of the game and must likewise be considered conduct unworthy of a member of the coaching profession.

### **Holding**

Illegal use of the hand or arm is unfair play, eliminates skill and does not belong in the game. The object of the game is to advance the ball by strategy, skill and speed without illegally holding your opponent. All coaches and players should thoroughly understand the rules for proper offensive and defensive use of the hands. Holding is a frequently called penalty; it is important to emphasize the severity of the penalty.

### **Sportsmanship**

The football player or coach who intentionally violates a rule is guilty of unfair play and unsportsmanlike conduct; and whether or not they escape being penalized, these actions discredit to the good name of the game, which is their duty as a player or coach to uphold.

NCAA FOOTBALL RULES COMMITTEE

---

# Part I:

## The Rules

---

NCAA Football Rules and Interpretations have been designated as either administrative rules or conduct rules. Typically, administrative rules are those dealing with preparation for the contest. Conduct rules are those that have to do directly with the playing of the contest. Some administrative rules (as indicated) may be altered by the mutual consent of the competing institutions. Others (as indicated) are unalterable. No conduct rule may be changed by mutual consent. All NCAA member institutions are required, as a condition of membership, to conduct their intercollegiate contests according to these rules.

**In the NCAA Football Rules and Interpretations, administrative rules that may be altered by mutual consent of the institutions include:**

3-2-1-b	3-3-3-c and d
3-2-2-a	11-2-1

**Administrative rules that may not be altered include:**

1-1-1-a	1-2-7-a, b, e and f
1-1-2	1-2-8-a-d
1-1-3-a and b	1-2-9-a and b
1-1-4	1-3-1
1-1-5	1-3-2-b, c, e and f
1-1-6	1-3-2-d Exception
1-1-7	1-4-3
1-2-1	1-4-7
1-2-1-a-d, h, k and l	1-4-9
1-2-2	<a href="#">1-4-12</a>
1-2-3-a and b	3-2-4
1-2-4-a-e	3-3-3-e
1-2-5	11-1
1-2-6	11-2-2

**Administrative rules that may be altered by game management without mutual consent include:**

1-2-1-a Exception	1-2-7-c and d
1-2-1-e, f, g, i and j	1-3-2-d
1-2-4-f	
1-2-5-c Exception	

**All other rules are conduct rules and may not be altered.**



---

# RULE 1

## The Game, Field, Players and Equipment

---

### SECTION 1. General Provisions

#### The Game

ARTICLE 1. a. The game shall be played between two teams of not more than 11 players each, on a rectangular field and with an inflated ball having the shape of a prolate spheroid.

b. A team legally may play with fewer than 11 players, but a foul for an illegal formation occurs if the following requirements are not met:

1. When the ball is free-kicked, at least four Team A players are on each side of the kicker (Rule 6-1-2-c-3).
2. At the snap, at least five players wearing jerseys numbered 50 through 79 are on the offensive scrimmage line and no more than four players are in the backfield (Rules 2-21-2, 2-27-4 and 7-1-4-a) (**Exception:** Rule 7-1-4-a-5) (A.R. 7-1-4-IV-VI).

#### Goal Lines

ARTICLE 2. Goal lines, one for each team, shall be established at opposite ends of the field of play, and each team shall be allowed opportunities to advance the ball across the other team's goal line by running, passing or kicking it.

#### Winning Team and Final Score

ARTICLE 3. a. The teams shall be awarded points for scoring according to rule and, unless the game is forfeited, the team having the larger score at the end of the game shall be the winning team.

b. When the referee declares that the game is ended, the score is final.

#### Game Officials

ARTICLE 4. The game shall be played under the supervision of the game officials as specified in Rule 11.

#### Team Captains

ARTICLE 5. Each team shall designate to the referee not more than four players as its field captain(s). One player at a time shall speak for their team in all dealings with the officials.

#### Persons Subject to the Rules

ARTICLE 6. a. All persons subject to the rules are governed by the decisions of the officials.

- b. Those persons subject to the rules are: Everyone in the team area, players, substitutes, replaced players, coaches, athletics trainers, cheerleaders, band members, mascots, public-address announcers, audio/video/lighting system operators, and other persons affiliated with the teams or institutions.

### **Member Institutions Subject to the Rules**

ARTICLE 7. a. NCAA member institutions and affiliated officiating organizations shall conduct all contests under the official football-playing rules of the Association.

- b. NCAA-affiliated officiating organizations shall use the current Football Officials Manual published under the jurisdiction of the College Football Officiating, LLC (CFO).
- c. NCAA member institutions and affiliated officiating organizations not complying with NCAA football-playing rules are subject to sanctions (See appropriate divisional NCAA Manual).

## **SECTION 2. The Field**

### **Dimensions and Markings**

ARTICLE 1. The field shall be a rectangular area with dimensions, lines, zones, goals and pylons as indicated in Appendix D.

- a. All field-dimension lines shown must be white and 4 inches in width (**Exceptions:** Sidelines and end lines may exceed 4 inches in width, goal lines may be 4 or 8 inches in width, and Rule 1-2-1-g).
- b. Twenty-four-inch short yard-line extensions, four inches inside the sidelines and at the hash marks, are mandatory; and all yard lines shall be four inches from the sidelines (Rule 2-12-6).
- c. A solid white area between the sideline and the coaching line is mandatory.
- d. White field markings or contrasting decorative markings (e.g., team names) are permissible in the end zones but shall not be closer than four feet to any line.
- e. Contrasting coloring in the end zones may abut any line.
- f. Only these contrasting decorative markings are allowed: conference logo, NCAA logo, college or university name and logo, and team name and logo. These are permissible within the sidelines and between the goal lines, under these conditions (See Appendix D):
  1. The entirety of all yard lines, goal lines, and sidelines must be clearly visible. No portion of any such line may be obscured by decorative markings.
  2. No such markings may touch or enclose the hash marks or numbers.
  3. A single decorative marking, centered on the 50-yard line, and a maximum of four smaller flanking decorative markings are allowed.
- g. Goal lines may be of one contrasting color from the white lines.
- h. Advertising is prohibited on the field except as follows:
  1. For postseason and neutral-site games the title sponsor whose name is associated with the name of that game may advertise on the field, with the restriction that there be a maximum of three such advertisements: a single advertisement centered on the 50-yard line and no more than two smaller flanking advertisements. These advertisements must

adhere to paragraph f above. No other advertisements, either by the title sponsor or by any other commercial entity, may be on the field.

2. The NCAA Football logo is permitted.
3. If a commercial entity or individual has purchased naming rights to the facility, that entity's or individual's name/company-specific font or logo may be painted on the field in no more than two of the flanking locations and will count in the total of the maximum of four flanking locations allowed.
  - i. White field yard-line numbers not larger than 6 feet in height and 4 feet in width, with the tops of the numbers nine yards from the sidelines, are recommended.
  - j. White directional arrows next to the field numbers (except the 50) indicating the direction toward the nearest goal line are recommended. The arrow is a triangle with an 18-inch base and two sides that are 36 inches each.
  - k. The two hash marks are 60 feet from the sidelines. Hash marks and short yard-line extensions shall measure 24 inches in length.
  - l. Nine-yard marks 12 inches in length, every 10 yards, shall be located nine yards from the sidelines. They are not required if the field is numbered according to Rule 1-2-1-i.

### **Marking Boundary Areas**

ARTICLE 2. Measurements shall be from the inside edges of the boundary markings. The entire width of each goal line is in the end zone.

### **Limit Lines**

ARTICLE 3. a. Limit lines shall be marked with 12-inch lines and at 24-inch intervals 12 feet outside the sidelines and the end lines, except in stadiums where total field surface does not permit. In these stadiums, the limit lines shall not be less than six feet from the sidelines and end lines. Limit lines shall be 4 inches in width and may be yellow. Limit lines designating team areas shall be solid lines.

- b. No person outside the team area shall be inside the limit lines. Game management personnel have the responsibility and the authority to enforce this rule. (**Exception:** Hand-held cameras under the supervision of the television partners may briefly be between the limit lines and the sideline after the ball is dead and the game clock has been stopped. This exception does not allow cameras to be on the field of play or in the end zone at any time.)
- c. Limit lines shall also be marked six feet from the team area around the side and back of the team area, if the stadium permits.

### **Team Area and Coaching Box**

ARTICLE 4. a. On each side of the field, a team area in back of the limit line and between the 20-yard lines shall be marked for the exclusive use of substitutes, athletics trainers and other persons affiliated with the team. The front of the coaching box shall be marked with a solid line six feet outside the sideline between the 20-yard lines. The area between the coaching line and the limit line between the 20-yard lines shall contain white diagonal lines or be marked distinctly for use of coaches (Rule 9-2-5). A 4-inch-by-4-inch mark is

mandatory at each five-yard line extended between the goal lines as an extension of the coaching line for line-to-gain and down indicator six-foot reference points.

- b. The team area shall be limited to squad members in full uniform (see Appendix D) and a maximum of 50 other individuals directly involved in the game. All persons in the team area are subject to the rules and are governed by decisions of the officials (Rule 1-1-6). The 50 individuals not in full uniform shall wear special team area credentials numbered 1 through 50. No other credentials are permitted. Medical personnel are exempted from the 50-credential limit and should have a separate, distinct pass.
- c. Coaches are permitted in the coaching box (see Appendix D), which is the area bounded by the limit line and coaching line between the 20-yard lines.
- d. No media personnel, including journalists, radio and television personnel, or their equipment, shall be in the team area or coaching box, and no media personnel shall communicate in any way with persons in the team area or coaching box. In stadiums where the team area extends to the spectator seating area, a pass-through area should be made available for media to move from one end of the field to the other on both sides of the field.
- e. Game management personnel shall remove all persons not authorized by rule.
- f. Practice kicking nets are not permitted outside the team area (**Exception:** In stadiums where playing enclosures are limited in size, nets, holders and kickers are permitted outside the team area and outside the limit line) (Rule 9-2-1-b-1).

## Goals

ARTICLE 5. a. Each goal shall consist of two white or yellow uprights extending at least 30 feet above the ground with a connecting white or yellow horizontal crossbar, the top of which is 10 feet above the ground. The inside of the uprights and crossbar shall be in the same vertical plane as the inside edge of the end line. Each goal is out of bounds (see Appendix D).

- b. Above the crossbar, the uprights shall be white or yellow and 18 feet, six inches apart inside to inside.
- c. The designated uprights and crossbar shall be free of decorative material (**Exception:** 4-inch-by-42-inch orange or red wind directional streamers at the top of the uprights are permitted).
- d. The height of the crossbar shall be measured from the top of each end of the crossbar to the ground directly below.
- e. Goal posts shall be padded with resilient material from the ground to a height of at least six feet. Advertising is prohibited on the goals. One manufacturer's logo or trademark is permitted on each goal post pad. Institutional and conference logos are allowed.
- f. The home team is responsible for the availability of a portable goal if original goals are removed during the game for any reason.

## Pylons

ARTICLE 6. Soft, flexible four-sided pylons 4 inches by 4 inches with an overall height of 18 inches, which may include a 2-inch space between the bottom of the pylon and the ground, are required. They shall be red or orange in color. One manufacturer's logo or trademark is permitted on each pylon. Institutional

logos, conference logos and the name/commercial logo of the title sponsor of postseason games are also allowed. Any such marking may not extend more than 3 inches on any side. They are placed at the inside corners of the eight intersections of the sidelines with the goal lines and end lines. The pylons marking the intersections of the end lines and hash marks extended shall be placed three feet off the end lines.

### **Line-to-Gain and Down Indicators**

ARTICLE 7. The official line-to-gain (yardage chain) and down indicators shall be operated approximately six feet outside the sideline except in stadiums where the total playing enclosure does not permit. These must be operated on the side of the field opposite the press box.

- a. The yardage chain shall join two rods not fewer than 5 feet high, the rods' inside edges being exactly 10 yards apart when the chain is fully extended.
- b. The down indicator shall be mounted on a rod not fewer than 5 feet high operating approximately six feet outside the sideline opposite the press box.
- c. An unofficial auxiliary line-to-gain indicator and an unofficial down indicator six feet outside the other sideline are recommended.
- d. Unofficial red or orange nonslip line-to-gain ground markers positioned off the sidelines on both sides of the field are recommended. Markers are rectangular, weighted material 10 inches by 32 inches. A triangle with an altitude of 5 inches is attached to the rectangle at the end toward the sideline.
- e. All line-to-gain and down-indicator rods shall have flat ends.
- f. Advertising is prohibited on the down and line-to-gain indicators. One manufacturer's logo or trademark is permitted on each indicator. Institutional and conference logos are allowed.

### **Markers or Obstructions**

ARTICLE 8. a. All markers and obstructions within the playing enclosure shall be placed or constructed in such a manner as to avoid any possible hazard to players. This includes anything dangerous to anyone at the limit lines.

- b. After the officials' pregame inspection of the playing enclosure, the referee shall order removed any hazardous obstructions or markers located inside the limit lines.
- c. The referee shall report to game management personnel any markers or obstructions constituting a hazard within the playing enclosure but outside the limit lines. Final determination of corrective action shall be the responsibility of game management personnel.
- d. After the officials have completed their pregame inspection of the playing enclosure, it is the responsibility of game management personnel to ensure that the playing enclosure remains safe throughout the game.

### **Field Surface**

ARTICLE 9. a. No material or device shall be used to improve or degrade the playing surface or other conditions and give one player or team an advantage (**Exceptions:** Rules 2-16-4-b and c).

**PENALTY—Live-ball foul. Five yards from the previous spot [S19].**

- b. The referee may require any improvement in the field necessary for proper and safe game administration.

### SECTION 3. The Ball

#### Specifications

ARTICLE 1. The ball shall meet the following specifications:

- a. New or nearly new. (A nearly new ball is a ball that has not been altered and retains the properties and qualities of a new ball.)
- b. Cover consisting of four panels of pebble-grained leather without corrugations other than seams.

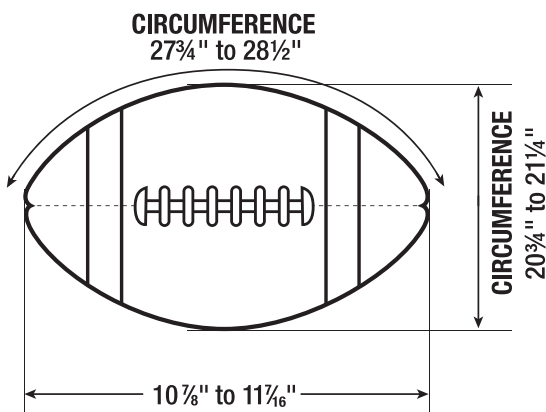

- c. One set of eight equally spaced lacings.
- d. Natural tan color.
- e. Two 1-inch white stripes that are three to three-and-one-quarter inches from the end of the ball and located only on the two panels adjacent to the laces.
- f. Conforms to maximum and minimum dimensions and shape indicated in the accompanying diagram.
- g. Inflated to the pressure of 12-1/2 to 13-1/2 pounds per square inch (psi).
- h. Weight of 14 to 15 ounces.
- i. The ball may not be altered. This includes the use of any ball-drying or ball-warming substance. Mechanical ball-drying and ball-warming devices are not permitted near the sidelines or in the team area.
- j. Professional football league logos are prohibited.
- k. Advertising is prohibited on the ball [**Exceptions:** (1) Ball manufacturer's name or logo, (2) institutional logo, (3) conference/NCAA logo, (4) AFCA logo and (5) College Football Playoff logo].

## Administration and Enforcement

ARTICLE 2. a. The game officials shall test and be sole judge of not more than 10 balls offered for play by each team before and during the game. The game officials may approve additional balls if warranted by conditions.

- b. Home management shall provide a pressure pump and measuring device.
- c. The home team is responsible for providing legal balls and should notify the opponent of the ball to be used.
- d. During the entire game, either team may use a new or nearly new ball of its choice when it is in possession, providing the ball meets the required specifications and has been measured and tested according to rule (*Exception:* The official NCAA football shall be used for the Division I Football Championship Subdivision, II and III championships).
- e. The visiting team is responsible for providing the legal balls it wishes to use while it is in possession if the balls provided by the home team are not acceptable.
- f. All balls to be used must be presented to the referee for testing at least 60 minutes before the start of the game. Once the teams have presented the game balls to the referee, they remain under the general supervision of the officials throughout the game.
- g. When the ball becomes dead in a side zone, is unfit for play, is subject to measurement in a side zone or is inaccessible, a replacement ball shall be obtained from a ball person (A.R. 1-3-2-1).
- h. The referee or umpire shall determine the legality of each ball before it is put in play.
- i. The following procedures shall be used when measuring a ball:
  1. All measurements shall be made after the ball is legally inflated.
  2. The long circumference shall be measured around the ends of the ball but not over the laces.
  3. The long diameter shall be measured with calipers from end to end but not in the nose indentation.
  4. The short circumference shall be measured around the ball, over the valve and over the lace but not over the cross lace.

## Marking Balls

ARTICLE 3. Marking a ball indicating a preference for any player or any situation is prohibited.

**PENALTY—Live-ball foul. 15 yards from the previous spot [S27].**

## SECTION 4. Players and Playing Equipment

### Recommended Numbering

ARTICLE 1. It is strongly recommended that offensive players be numbered according to the following diagram that shows one of many offensive formations:





### Players' Numbering

ARTICLE 2. a. All players shall be numbered 0 through 99. Any number preceded by the digit zero such as "07" or "00" is illegal.

- b. No two players of the same team shall participate in the same down wearing identical numbers.
- c. Markings in the vicinity of the numbers are not permitted.

**PENALTY [a-c]—Live-ball foul. Five yards from the previous spot [S23].**

- d. When a player enters the game after changing their jersey number, the player must report to the referee. The officiating crew informs the opposing head coach and the referee announces the change. A player who enters the game after changing their number and does not report commits a foul for unsportsmanlike conduct. [S27]. (A.R. 1-4-2-1)

**PENALTY [d]—Live-ball foul. 15 yards from the previous spot [S27]. Flagrant offenders shall be ejected [S47].**

### Mandatory Equipment

ARTICLE 3. All players must wear the following mandatory equipment:

- a. Helmet.
- b. Hip pads.
- c. Jersey.
- d. Knee pads.
- e. Mouthpiece.
- f. Pants.
- g. Shoulder pads.
- h. Socks.
- i. Thigh guards.

### Specifications: Mandatory Equipment

ARTICLE 4. a. *Helmets.* 1. The helmet must be fitted with a facemask and a secured four- or six-point chin strap, all points of which must be secured whenever the ball is in play.

2. Helmets for all players of a team must be of the same color and design.
  3. Helmets must carry a warning label regarding the risk of injury and a manufacturer's or reconditioner's certification indicating satisfaction of National Operating Committee on Standards for Athletic Equipment (NOCSAE) test standards. Reconditioned helmets shall show recertification to indicate satisfaction with the NOCSAE test standard.
- b. *Hip Pads.* Hip pads must include a tailbone protector.

- c. *Jersey.* See Rule 1-4-5
- d. *Knee Pads.* Knee pads must be covered by pants. Furthermore, the pants and knee pads must cover the knees. No pads or protective equipment may be worn outside the pants. (See Appendix E.)
- e. *Mouthpiece.* The mouthpiece must be an intra-oral device of any readily visible color. It must not be white or transparent. It must be made with FDA-approved base materials (FDCS) and cover all upper teeth. It is recommended that the mouthpiece be properly fitted.
- f. *Pants.* Players of a team must wear pants of the same color and design.
- g. *Shoulder pads.* There are no specifications for shoulder pads. (See Appendix E)
- h. *Socks.* Players of a team must wear socks or leg coverings that are identical in color and design (**Exceptions:** Unaltered knee braces, tape or a bandage to protect or prevent an injury, and barefoot kickers).
- i. *Thigh guards.* There are no specifications for thigh guards. (See Appendix E)

### Jersey Design, Color and Numerals

#### ARTICLE 5. a. Design.

1. The jersey must have sleeves that completely cover the shoulder pads. It must not be altered or designed to tear. The jersey must be full-length and tucked into the pants or made even with the waistline. No other undergarment (e.g., T-shirt) shall extend below the waistline at the torso. It must cover all pads worn at or above the waist. A second jersey meeting all requirements of Rule 1-4-5 worn concurrently is allowed. Vests and/or altered jerseys with zippers, Velcro, clasps or other fasteners are not allowed.
2. Other than the player's number, the jersey may only contain:
  - Player's name;
  - School name;
  - City and/or state of the institution;
  - Mascot name;
  - NCAA logo;
  - Sleeve stripes;
  - Logo for school, conference, mascot, postseason-game, memorial, the military;
  - Graduate or academic recognition as part of an institutional or conference logo;
  - The letter "C" to identify a team captain;
  - American flag;
  - State flag.
3. Any item in paragraph 2 must not exceed 16 square inches in area (i.e., rectangle, square, parallelogram), including any additional material (e.g., patch).
4. A border around the collar and cuffs not more than 1 inch wide is permissible, as is a maximum 4-inch stripe along the side seam (insert from the underarm to pants top).
5. Jerseys may not be taped or tied in any manner.

*Note: The uniform diagram in Appendix E may assist in the understanding of these rules.*

b. *Color.*

1. Players of opposing teams shall wear jerseys of contrasting colors. Players on the same team shall wear jerseys of the same color and design.
2. The visiting team shall wear white jerseys; however, the home team may wear white jerseys if the teams have agreed in writing before the season.
3. If the home team wears colored jerseys, the visiting team may also wear colored jerseys, if and only if the following conditions have been satisfied
  - a. The home team has agreed in writing prior to the game; and
  - b. The conference of the home team certifies that the jersey of the visiting team is of a contrasting color.
4. If on the kickoff at the start of each half, the visiting team wears a colored jersey in violation of the conditions specified in paragraph 3, it is a foul for unsportsmanlike conduct.

**PENALTY—Administer as a dead-ball foul. 15 yards at the succeeding spot following the kickoff. If the kickoff is returned for a touchdown, the penalty is assessed either on the try or on the succeeding kickoff, at the option of the home team. [S27] In addition, Officials shall charge a team timeout at the start of each quarter the illegal jerseys are worn, or a foul for delay of the game if all timeouts have been used.**

5. If a colored jersey contains white, it may appear only as any of the items listed in paragraph a-2 above.

c. *Numerals.*

1. The jersey must have clearly visible, permanent Arabic numerals measuring at least 8 and 10 inches in height front and back, respectively. The number must be of a color that itself is clearly in distinct contrast with the color of the jersey, irrespective of any border around the number.
2. Teams wearing jerseys/numerals that do not conform to this rule will be asked to change into legal jerseys before the game and before the start of the second half. On the kickoff at the start of each half, if a team wears a jersey in violation of the conditions specified in paragraph 1, it is a foul for unsportsmanlike conduct.

**PENALTY—Administer as a dead-ball foul. 15 yards at the succeeding spot following the kickoff. If the kickoff is returned for a touchdown, the penalty is assessed either on the try or on the succeeding kickoff, at the option of the home team. [S27] In addition, Officials shall charge a team timeout at the start of each quarter the illegal jerseys are worn, or a foul for delay of the game if all timeouts have been used. (A. R. 1-4-5-I)**

3. All players of a team shall have the same color and style numbers front and back. The individual bars must be approximately 1-1/2 inches wide. Numbers on any part of the uniform shall correspond with the mandatory front and back jersey numbers.

## Optional Equipment

ARTICLE 6. The following items are legal:

- a. *Towels and Hand Warmers.* 1. Solid white towels no smaller than 4" by 12" and no larger than 6" by 12" with no words, symbols, letters, or numbers. Towels may bear the team logo. They may also contain a single manufacturer's or distributor's normal label or trademark not to exceed 2-1/4 square inches in area. Towels that are not solid white are not permitted.  
2. Hand warmers worn during inclement weather.
- b. *Gloves.*
  1. A glove is a fitted covering for a hand having separate sections for each finger and thumb, without any additional material that connects any of the fingers and/or thumb, and that completely covers each finger and thumb. There is no restriction on the color of gloves.
  2. Gloves must have a securely attached label or stamp ("NF/NCAA Specifications") indicating voluntary compliance with appropriate test specifications on file with either the Sports and Fitness Industry Association (SFIA) or the National Operating Committee on Standards for Athletic Equipment (NOCSAE), unless made of unaltered plain cloth.
- c. *Eye shields.* Eye shields must be clear, not tinted, and made from molded or rigid material. Eyeglasses and goggles also must be clear and not tinted. No medical exceptions are allowed.
- d. *Insignia.* 1. Persons or events may be memorialized by an insignia with an area not greater than 16 square inches on the uniform or helmet.  
2. Institutional decals are allowed on helmets.
- e. *Eye shade.* Any shading under a player's eyes must be solid black with no words, numbers, logos or other symbols.
- f. *Game information.* Any player may have written game information on the wrist, arm or belt.

## Illegal Equipment

ARTICLE 7. Illegal equipment includes the following (See Appendix E for additional details):

- a. Equipment worn by a player that could endanger other players.
- b. Tape or any bandage other than that used to protect an injury, subject to the approval of the umpire.
- c. Hard, abrasive or unyielding equipment that is not completely covered and padded, subject to the approval of the umpire.
- d. Cleats that extend more than 1/2 inch from the base of the shoe (See Appendix E for full specifications). (Rule 9-2-2-f)
- e. Any equipment that could confuse or deceive an opponent.
- f. Any equipment that could provide an unfair advantage to any player.
- g. Adhesive material, paint, grease or any other slippery substance applied to equipment or a player's person, clothing or attachment [**Exception:** Eye shade. (Rule 1-4-6-e)].
- h. Uniform attachments other than towels (Rule 1-4-6-a).
- i. Rib pads, shoulder pad attachments and back protectors that are not totally covered. (A.R. 1-4-7-II)

- j. Visible bandannas worn on the field outside the team area (A.R. 1-4-7-I).
- k. Jerseys that do not conform with Rule 1-4-5.
- l. Non-standard overbuilt facemask.(A.R.1-4-7-IV)

### **Mandatory and Illegal Equipment Enforcement**

ARTICLE 8. a. No player wearing illegal equipment or failing to wear mandatory equipment shall be permitted to play. (*Exception:* Rule 1-4-5-b and c)

- b. If an official discovers illegal equipment, or if a player is not wearing mandatory equipment, the player must leave the game for at least one down and is not allowed to return until the equipment is made legal. The player may be allowed to return without missing a down if the team takes a charged team timeout, but in any event the player may not play with illegal equipment or without mandatory equipment.
- c. If equipment becomes illegal through play, the player is not required to leave the game for one down, but the player may not participate until the equipment is made legal. (A.R. 1-4-7-II)

### **Coaches' Certification**

ARTICLE 9. The head coach or their designated representative shall certify in writing to the umpire before the game that all players:

- a. Have been informed what equipment is mandatory by rule and what constitutes illegal equipment.
- b. Have been provided the equipment mandated by rule.
- c. Have been instructed to wear and how to wear mandatory equipment during the game.
- d. Have been instructed to notify the coaching staff when equipment becomes illegal through play during the game.

### **Prohibited Signal Devices**

ARTICLE 10. Players may not be equipped with any electronic, mechanical or other signal devices for the purpose of communicating with any source (*Exceptions:* 1. A medically prescribed hearing aid of the sound-amplifier type for hearing-impaired players. 2. A device for transmission or reception of data specifically and only for purposes of health and safety.)

**PENALTY—Administer as a dead-ball foul. 15 yards at the succeeding spot. Player is ejected [S7, S27 and S47].**

### **Prohibited Field Equipment**

ARTICLE 11. Jurisdiction regarding the presence and location of communication equipment (cameras, sound devices, etc.) within the playing enclosure resides with game management personnel.

- a. Television replay or monitor equipment is prohibited at the sidelines, press box or other locations within the playing enclosure for coaching purposes during the game. Motion pictures, any type of film, facsimile machines, videotapes, photographs, writing-transmission machines and computers may not be used by coaches or for coaching purposes any time during the game or between periods. Computers, tablets, etc. are not allowed in the coaching booth.

**[Exceptions:** 1) Monitors may be used only to view the live telecast or webcast. The home team is responsible for assuring identical television capability in the coaches' booths of both teams. This capability may not include replay equipment or recorders. 2) A monitor is permitted on the sideline only to assist team medical staffs in the diagnosis and treatment of student-athletes.]

- b. Only voice communication between the press box and team area is permitted. Coaches' booth space and location must be approximately equivalent for the home and visiting teams and should be located in the traditional press box area. Where press-box space is not adequate, only voice communication may originate from any area in the stands between the 20-yard lines extended to the top of the stadium. No other communication for coaching purposes is permitted anywhere else, including communication from outside the stadium (remote coaching).
- c. Media communication equipment, including cameras, sound devices, computers and microphones, is prohibited on or above the field, or in or above the team area (Rule 2-31-1).

**Exceptions:**

- 1. Camera equipment attached to a goal support behind the uprights and crossbar.
- 2. Camera(s) embedded in any pylon.
- 3. A camera, with no audio component, may be attached to the cap of any official with prior approval of the conference and the participating institutions.
- 4. A camera, with no audio component, may be attached to cables that extend over the team area and field of play, including the end zones.
- 5. An institutional videographer may be in the team area as one of that institution's 50 credentialed individuals. This video may not be used during any live broadcast or digital stream of the game.
- d. Microphones attached to coaches during the game for media transmission are prohibited. (**Exception:** A microphone may be attached to the head coach for institutional use only after the conclusion of the live broadcast.)
- e. Team personnel may not be interviewed from the start of the first period until the referee declares the game ended (**Exception:** Only coaches may be interviewed between the conclusion of the second period and the beginning of the third period).
- f. No one in the team area or coaching box may use any artificial sound amplification to communicate with players on the field.
- g. Any attempt to record, either through audio or video means, any signals given by an opposing player, coach or other team personnel is prohibited.

**Coaches' Phones, Headsets and Communication Devices**

ARTICLE 12. Coaches' phones, headsets and communication devices are not subject to playing rules penalties before or during the game.

- a. A conference may develop a policy to provide guidance in handling situations dealing with failure of coaches' headsets.
- b. For Division I Football Bowl Subdivision (FBS) football, within game management responsibility, each team may use a maximum of 23 headsets with guidelines as follows:

1. Fifteen (15) of the headsets may be used by countable coaches and graduate assistants for coaching purposes.
  2. Three (3) “listen only” headsets may be used in the Coaches Booth by individuals who are full time undergraduate students or are within 10 years of exhaustion of eligibility or, if earlier, college graduation. Only countable coaches, graduate assistants and the three individuals using the “listen only” devices may be in the coaches’ booth. (**Exception:** One communication technician.)
  3. Four (4) of the headsets may only be used by Squad Members or up to four designated full-time undergraduate students.
  4. The one remaining headset may be used on the field for non-coaching activity.
  5. Headsets that are used for medical, game operations, security, etc. staffs are exempt from these limitations, provided the communication is separate from coaching communication devices.
  6. One communication technician in the team area and one communication technician in the coaches’ booth may be on the coaching headsets to monitor and handle any technical issues with the headsets outside of the allowable 23 devices.
- c. For all other NCAA football programs, each team may use a maximum of 23 headsets with category limits managed at each conference’s direction.

### **Referee Communication**

ARTICLE 13. a. A microphone is mandatory for the referee to be used for all game announcements. It is strongly recommended that it be a lapel-type microphone. The microphone must be controlled by the referee. It may not be open at other times. Microphones on other officials are prohibited.

b. A protected wireless official-to-official communication system (i.e., O2O) open only to the officiating crew, instant replay and conference officiating observer is permitted.

---

# RULE 2

## Definitions

---

### SECTION 1. Approved Rulings and Official's Signals

ARTICLE 1. a. An approved ruling (A.R.) is an official decision on a given statement of facts. It serves to illustrate the spirit and application of the rules. The relationship between the rules and an approved ruling is analogous to that between statutory law and a decision of the Supreme Court.

b. An official's signal [S] refers to the Official Football Signals 1 through 47.

### SECTION 2. The Ball: Live, Dead, Loose, Ready For Play

#### Live Ball

ARTICLE 1. A live ball is a ball in play. A pass, kick or fumble that has not yet touched the ground is a live ball in flight.

#### Dead Ball

ARTICLE 2. A dead ball is a ball not in play.

#### Loose Ball

ARTICLE 3. a. A loose ball is a live ball not in player possession during:

1. A running play.
2. A scrimmage or free kick before possession is gained or regained or the ball is dead by rule.
3. The interval after a legal forward pass is touched and before it becomes complete, incomplete or intercepted. This interval is during a forward pass play, and any player eligible to touch the ball may bat it in any direction.

b. All players are eligible to touch, catch or recover a fumble (*Exceptions:* Rules 7-2-2-a-Exc.2 and 8-3-2-d-5) or a backward pass.

c. Eligibility to touch a kick is governed by kick rules (Rule 6).

d. Eligibility to touch a forward pass is governed by pass rules (Rule 7).

#### When Ball Is Ready for Play

ARTICLE 4. A dead ball is ready for play when:

- a. With the 40-second play clock running, an official places the ball at a hash mark or between the inbounds marks and steps away to their position.
- b. With the play clock set at 25 seconds, or at 40 seconds after an injury to or loss of helmet by a defensive team player, the referee sounds their whistle and either signals to start the game clock [S2] or signals that the ball is ready for play [S1]. (A.R. 4-1-4-I and II)



## SECTION 3. Blocking

### Blocking

ARTICLE 1. a. Blocking is obstructing an opponent by intentionally contacting the opponent with any part of the blocker's body.

b. Pushing is blocking an opponent with open hands.

### Below Waist

ARTICLE 2. a. A block below the waist is a block in which the force of the initial contact is below the waist of an opponent who has one or both feet on the ground. When in question, the contact is below the waist (Rule 9-1-6).

b. A blocker who makes contact above the waist and then slides below the waist has not blocked below the waist. If the blocker first contacts the opposing player's hands at the waist or above, it is a legal "above the waist" block (Rule 9-1-6).

### Chop Block

ARTICLE 3. A chop block is a high-low or low-high combination block by any two players against an opponent (not the ball carrier) anywhere on the field, with or without a delay between blocks; the "low" component is at the opponent's thigh or below. (A.R. 9-1-10-I-IV). It is not a foul if the blockers' opponent initiates the contact. (A.R. 9-1-10-V)

### Block in the Back

ARTICLE 4. a. A block in the back is contact against an opponent occurring when the force of the initial contact is from behind and above the waist. When in question, the contact is at or below the waist (see Clipping, Rule 2-5) (Rule 9-3-5) (A.R. 9-3-3-I-VII and A.R. 10-2-2-XII).

b. The position of the blocker's head or feet does not necessarily indicate the point of initial contact.

### Frame of the Body

ARTICLE 5. The frame of a player's body is at the shoulders or below other than the back [Rule 9-3-3-a-1-(b) Exception].

### Blocking Zone

ARTICLE 6. a. The blocking zone is a rectangle centered on the middle lineman of the offensive formation and extending five yards laterally and three yards longitudinally in each direction.

b. The blocking zone disintegrates when the ball leaves the zone.

### Blind-Side Block

ARTICLE 7. A blind-side block is an open field block against an opponent that is initiated from outside the opponent's field of vision, or otherwise in such a manner that the opponent cannot reasonably defend themselves against the block.

## SECTION 4. Catch, Recovery, Possession

### Possession

ARTICLE 1. Possession refers to custody of (a) a live ball as described later in this article and (b) a dead ball to be snapped or free-kicked. It may refer either to player possession or team possession.

a. Player Possession.

The ball is in player possession when a player has the ball firmly in their grasp by holding or controlling it with hand(s) or arm(s) while contacting the ground inbounds.

b. Team Possession.

The ball is in team possession:

1. When one of its players has player possession, including when they are attempting a punt, drop kick or place kick; or
2. While a forward pass thrown by a player of that team is in flight; or
3. During a loose ball if a player of that team last had player possession; or
4. When the team is next to snap or free kick the ball.

c. A team is in legal possession if it has team possession when its players are eligible to catch or recover the ball.

### Belongs To

ARTICLE 2. "Belongs to," as contrasted with "in possession," denotes custody of a dead ball. Such custody may be temporary, because the ball must next be put in play in accordance with rules governing the existing situation.

### Catch, Interception, Recovery

ARTICLE 3. a. To catch a ball means that a player:

1. Secures firm control with the hand(s) or arm(s) of a live ball in flight before the ball touches the ground, and
2. Touches the ground in bounds with any part of the body, and then
3. Maintains control of the ball long enough to enable that player to perform an act common to the game, i.e., long enough to pitch or hand the ball, advance it, avoid or ward off an opponent, etc., and
4. Satisfies paragraphs b, c, and d below.

b. If a player goes to the ground in the act of catching a pass (with or without contact by an opponent) the player must maintain complete and continuous control of the ball throughout the process of contacting the ground, whether in the field of play or in the end zone. This is also required for a player attempting to make a catch at the sideline and going to the ground out of bounds. If the player loses control of the ball which then touches the ground before they regain control, it is not a catch. If the player regains control inbounds prior to the ball touching the ground it is a catch.

c. If the player loses control of the ball while simultaneously touching the ground with any part of their body, or if there is doubt that the acts were simultaneous, it is not a catch. If a player has control of the ball, a slight movement of the ball, even if it touches the ground, will not be considered

loss of possession; the player must lose control of the ball in order for there to be a loss of possession.

- d. If the ball touches the ground after the player secures control and continues to maintain control, and the elements above are satisfied, it is a catch.
- e. An interception is a catch of an opponent's pass or fumble.
- f. A catch by any kneeling or prone inbounds player is a completion or interception (Rules 7-3-6 and 7).
- g. A player recovers a ball if they fulfill the criteria in paragraphs a, b, c, and d for catching a ball that is still alive after hitting the ground.
- h. When in question, the catch, recovery or interception is not completed.

### **Simultaneous Catch or Recovery**

ARTICLE 4. A simultaneous catch or recovery is a catch or recovery in which there is joint possession of a live ball by opposing players inbounds (A.R. 7-3-6-I-II).

## **SECTION 5. Clipping**

ARTICLE 1. a. Clipping is a block against an opponent in which the force of the initial contact is from behind and at or below the waist (Rule 9-1-5).

- b. The position of the blocker's head or feet does not necessarily indicate the point of initial contact.

## **SECTION 6. Deliberate Dead-Ball Advance**

Deliberately advancing a dead ball is an attempt by a player to advance the ball after any part of their body, other than a hand or foot, has touched the ground or after the ball has been declared dead by rule (*Exception:* Rule 4-1-3-b Exception).

## **SECTION 7. Down, Between Downs and Loss of Down**

### **Down**

ARTICLE 1. A down is a unit of the game that starts after the ball is ready for play with a legal snap (scrimmage down) or legal free kick (free kick down) and ends when the ball becomes dead [*Exception:* The try is a scrimmage down that begins when the referee declares the ball ready for play (Rule 8-3-2-b)].

### **Between Downs**

ARTICLE 2. Between downs is the interval during which the ball is dead.

### **Loss of Down**

ARTICLE 3. "Loss of down" is an abbreviation meaning "loss of the right to repeat a down."

## **SECTION 8. Fair Catch**

### **Fair Catch**

ARTICLE 1. a. A fair catch of a scrimmage kick is a catch beyond the neutral zone by a Team B player who has made a valid signal during a scrimmage kick that is untouched beyond the neutral zone.

- b. A fair catch of a free kick is a catch by a Team B player who has made a valid signal during an untouched free kick.
- c. A valid or invalid fair catch signal deprives the receiving team of the opportunity to advance the ball. The ball is declared dead at the spot of the catch or recovery. If the catch precedes the signal, the ball is dead when the signal is first given.
- d. If the receiver shades their eyes from the sun without waving their hand(s), the ball is live and may be advanced.

### **Valid Signal**

ARTICLE 2. A valid signal is a signal given by a player of Team B who has obviously signaled their intention by extending one hand only clearly above their head and waving that hand from side to side of their body more than once.

### **Invalid Signal**

ARTICLE 3. An invalid signal is any waving signal by a player of Team B:

- a. That does not meet the requirements of Article 2 (above); or
- b. That is given after a scrimmage kick is caught beyond the neutral zone, strikes the ground or touches another player beyond the neutral zone (A.R. 6-5-3-III-V); or
- c. That is given after a free kick is caught, strikes the ground or touches another player. [*Exception:* Rule 6-4-1-f]

## **SECTION 9. Forward, Beyond and Forward Progress**

### **Forward, Beyond**

ARTICLE 1. Forward, beyond or in advance of, as related to either team, denotes direction toward the opponent's end line. Converse terms are backward or behind.

### **Forward Progress**

ARTICLE 2. Forward progress is a term indicating the end of advancement by the ball carrier or airborne pass receiver of either team and applies to the position of the ball when it becomes dead by rule (Rules 4-1-3-a, b and p; Rules 4-2-1 and 4; and Rule 5-1-3-a Exception) (A.R. 5-1-3-I-VI and A.R. 8-2-1-I-IX) (*Exception:* Rule 8-5-1-a, A.R. 8-5-1-I).

## **SECTION 10. Foul and Violation**

### **Foul**

ARTICLE 1. A foul is a rule infraction for which a penalty is prescribed.

### **Personal Foul**

ARTICLE 2. A personal foul is a foul involving illegal physical contact that endangers the safety of another player.

### **Flagrant Personal Foul**

ARTICLE 3. A flagrant personal foul is illegal physical contact so extreme or deliberate that it places an opponent in danger of catastrophic injury.

**Violation**

ARTICLE 4. A violation is a rule infraction for which no penalty is prescribed. Since it is not a foul, it does not offset a foul.

**SECTION 11. Fumble, Muff; Batting and Touching the Ball; Blocking a Kick****Fumble**

ARTICLE 1. To fumble the ball is to lose player possession by any act other than passing, kicking or successful handing (A.R. 2-19-2-I and A.R. 4-1-3-I). The status of the ball is a fumble.

**Muff**

ARTICLE 2. To muff the ball is to touch the ball in an unsuccessful attempt to catch or recover it. Muffing the ball does not change its status.

**Batting**

ARTICLE 3. Batting the ball is intentionally striking it or intentionally changing its direction with the hand(s) or arm(s). When in question, the ball is accidentally touched rather than batted. Batting the ball does not change its status.

**Touching**

ARTICLE 4. a. Touching a ball not in player possession denotes any contact with the ball. It may be intentional or unintentional, and it always precedes possession and control.

- b. Intentional touching is deliberate or intended touching.
- c. Forced touching results when a player's contact with the ball is due to (i) an opponent blocking that player into it, or (ii) the ball being batted or illegally kicked into that player by an opponent. If the touching is forced, the player in question by rule has not touched the ball (Rules 6-1-4 and 6-3-4)
- d. When in question, a ball has not been touched on a kick or forward pass.

**Blocking a Scrimmage Kick**

ARTICLE 5. Blocking a scrimmage kick is touching the kicked ball by an opponent of the kicking team in an attempt to prevent the ball from crossing the neutral zone (Rule 6-3-1-b).

**SECTION 12. Lines****Sidelines**

ARTICLE 1. A sideline runs from end line to end line on each side of the field and separates the field of play from the area that is out of bounds. The entire sideline is out of bounds.

**Goal Lines and Pylons**

ARTICLE 2. The goal line at each end of the field of play runs between the sidelines and is part of the vertical plane that separates the end zone from the field of play. The two goal lines are 100 yards apart. The plane of the goal line

extends between and includes the pylons, which are out of bounds. The entire goal line is in the end zone. A team's goal line is that which it is defending.

### **End Lines**

ARTICLE 3. An end line runs between the sidelines 10 yards behind each goal line and separates the end zone from the area that is out of bounds. The entire end line is out of bounds.

### **Boundary Lines**

ARTICLE 4. The boundary lines are the sidelines and the end lines. The area enclosed by the boundary lines is "in bounds," and the area surrounding and including the boundary lines is "out of bounds."

### **Restraining Lines**

ARTICLE 5. A restraining line is part of a vertical plane that limits a team's alignment for free kicks. The plane extends beyond the sidelines (A.R. 2-12-5-I).

### **Yard Lines**

ARTICLE 6. A yard line is any line in the field of play parallel to the end lines. A team's own yard lines, marked or unmarked, are numbered consecutively from its own goal line to the 50-yard line.

### **Hash Marks**

ARTICLE 7. The two hash marks are 60 feet from the sidelines. Hash marks and short yard-line extensions shall measure 24 inches in length.

### **Nine-Yard Marks**

ARTICLE 8. Nine-yard marks 12 inches in length, every 10 yards, shall be located nine yards from the sidelines. They are not required if the field is numbered according to Rule 1-2-1-i.

## **SECTION 13. Handing the Ball**

ARTICLE 1. a. Handing the ball is transferring player possession from one teammate to another without throwing, fumbling or kicking it.

- b. Except when permitted by rule, handing the ball forward to a teammate is illegal.
- c. Loss of player possession by unsuccessful execution of attempted handing is a fumble by the last player in possession [*Exception:* The snap (Rule 2-23-1-c)].
- d. A backward handoff occurs when the ball carrier releases the ball before it is beyond the yard line where the ball carrier is positioned.

## **SECTION 14. Huddle**

A huddle is two or more players grouped together after the ball is ready for play and before a snap or a free kick.

## SECTION 15. Hurdling

ARTICLE 1. a. Hurdling is an attempt by a player to jump with one or both feet or knees foremost over an opponent while that opponent is still on their feet (Rule 9-1-13).

- b. "On their feet" means that no part of the opponent's body other than one or both feet is in contact with the ground.

## SECTION 16. Kicks; Kicking the Ball

### Kicking the Ball; Legal and Illegal Kicks

ARTICLE 1. a. Kicking the ball is intentionally striking the ball with the knee, lower leg or foot.

- b. A legal kick is a punt, drop kick or place kick made according to the rules by a player of Team A before a change of team possession. Kicking the ball in any other manner is illegal (A.R. 6-1-2-1).
- c. Any free kick or scrimmage kick continues to be a kick until it is caught or recovered by a player or becomes dead.
- d. When in question, a ball is accidentally touched rather than kicked.

### Punt

ARTICLE 2. A punt is a kick by a player who drops the ball and kicks it before it touches the ground.

### Drop Kick

ARTICLE 3. A drop kick is a kick by a player who drops the ball and kicks it as it touches the ground.

### Place Kick

ARTICLE 4. a. A field goal place kick is a kick by a player of the team in possession while the ball is controlled on the ground by a teammate. (Rule 2-16-9)

- b. A tee is a device that elevates the ball for kicking purposes. It may not elevate the ball's lowest point more than one inch above the ground (A.R. 2-16-4-1). If utilized, a tee must be in contact with the ball for the kick to be legal.
- c. A free kick place kick is a kick by a player of the team in possession while the ball is positioned on a tee or the ground. It may be controlled by a teammate. The ball may be positioned on the ground and contacting the tee.
- d. No device or material may be used to mark the spot of a scrimmage place kick or to elevate the ball. This is a live-ball foul at the snap. (Rule 6-3-10-d)

### Free Kick

ARTICLE 5. a. A free kick is a kick by a player of the team in possession made under restrictions specified in Rules 4-1-4, 6-1-1 and 6-1-2.

- b. A free kick after a safety may be a punt, drop kick or place kick.

**Kickoff**

ARTICLE 6. A kickoff is a free kick that starts each half and follows each try or successful field goal attempt (*Exception:* In extra periods). It must be a place kick or a drop kick.

**Scrimmage Kick**

ARTICLE 7. a. A scrimmage kick is a punt, drop kick, or field goal place kick. It is a legal kick if it is made by Team A in or behind the neutral zone during a scrimmage down before team possession changes.

- b. A scrimmage kick has crossed the neutral zone when it touches the ground, a player, an official or anything beyond the neutral zone (*Exception:* Rule 6-3-1-b) (A.R. 6-3-1-I-IV).
- c. A scrimmage kick made when the kicker's entire body is beyond the neutral zone is an illegal kick and a live-ball foul that causes the ball to become dead (Rule 6-3-10-c).

**Return Kick**

ARTICLE 8. A return kick is a kick by a player of the team in possession after change of team possession during a down. It is an illegal kick and a live-ball foul that causes the ball to become dead (Rule 6-3-10-b).

**Field Goal Attempt**

ARTICLE 9. A field goal attempt is a scrimmage kick. It may be a place kick or drop kick.

**Scrimmage Kick Formation**

ARTICLE 10. a. A scrimmage kick formation is a formation with no player in position to receive a hand-to-hand snap from between the snapper's legs, and with either (1) at least one player 10 or more yards behind the neutral zone; or (2) a potential holder and potential kicker seven or more yards behind the neutral zone in position for a place kick. For either (1) or (2) to qualify as a scrimmage kick formation, it must be obvious that a kick will be attempted (A.R. 9-1-14-I-III)

- b. If Team A is in a scrimmage kick formation at the snap, any action by Team A during the down is deemed to be from a scrimmage kick formation.

**SECTION 17. The Neutral Zone**

ARTICLE 1. a. The neutral zone is the space between the two scrimmage lines extended to the sidelines. (Rule 2-21-2) Its width is equal to the length of the ball.

- b. The neutral zone is established when the ball is ready for play and is resting on the ground with its long axis at right angles to the scrimmage line and parallel to the sidelines.
- c. The neutral zone exists until there is a change of team possession, until a scrimmage kick crosses the neutral zone or until the ball is declared dead.



## SECTION 18. Encroachment and Offside

### Encroachment

ARTICLE 1. After the ball is ready for play, encroachment occurs when an offensive player is in or beyond the neutral zone after the snapper touches or simulates (hand[s] at or below their knees) touching the ball before the snap. (**Exception:** When the ball is put in play, the snapper is not encroaching when in the neutral zone.)

### Offside

ARTICLE 2. After the ball is ready for play, offside occurs (Rule 7-1-5) when a defensive player:

- a. Is in or beyond the neutral zone when the ball is legally snapped; or
- b. Contacts an opponent beyond the neutral zone before the ball is snapped; or
- c. Contacts the ball before it is snapped; or
- d. Threatens an offensive lineman, causing an immediate reaction, before the ball is snapped (Rule 7-1-2-b-3-Exception, A.R. 7-1-3-V Note); or
- e. Crosses the neutral zone and charges toward a Team A back (A.R. 7-1-5-III); or
- f. Is not behind their restraining line when the ball is legally free-kicked (Rule 6-1-2).

Offside occurs when one or more players of the kicking team are not behind their restraining line when the ball is legally free-kicked. (**Exception:** The kicker and holder are not offside when they are beyond their restraining line.)

## SECTION 19. Passes

### Passing

ARTICLE 1. Passing the ball is throwing it. A pass continues to be a pass until it is caught or intercepted by a player or the ball becomes dead.

### Forward and Backward Pass

ARTICLE 2. a. A pass is forward if the ball first strikes the ground, a player, an official or anything else beyond the spot where the ball is released. All other passes are backward passes. When in question a pass thrown in or behind the neutral zone is forward rather than a backward pass. (**Exception:** Games using Instant Replay)

- b. When a Team A player is holding the ball to pass it forward toward the neutral zone, any intentional forward movement of the passer's hand with the ball firmly in their control starts the forward pass unless the player clearly starts to bring the ball back with firm control to the passer's body. If a Team B player contacts the passer or ball after forward movement begins and the ball leaves the passer's hand, a forward pass is ruled regardless of where the ball strikes the ground or a player (A.R. 2-19-2-1).
- c. When in question, the ball is passed and not fumbled during an attempted forward pass. (**Exception:** Games using Instant Replay)

- d. A snap becomes a backward pass when the snapper releases the ball, other than via a hand-to-hand exchange (A.R. 2-23-1-I).

### **Crosses Neutral Zone**

ARTICLE 3. a. A legal forward pass has crossed the neutral zone when it first strikes the ground, a player, an official or anything beyond the neutral zone inbounds. It has not crossed the neutral zone when it first strikes the ground, a player, an official or anything in or behind the neutral zone inbounds.

- b. A player has crossed the neutral zone if that player's entire body has been beyond the neutral zone.
- c. A legal forward pass is beyond or behind the neutral zone where it crosses the sideline.

### **Catchable Forward Pass**

ARTICLE 4. A catchable forward pass is an untouched legal forward pass beyond the neutral zone to an eligible player who has a reasonable opportunity to catch the ball. When in question, a legal forward pass is catchable.

## **SECTION 20. Penalty**

A penalty is a result imposed by rule against a team that has committed a foul and may include one or more of the following: loss of yardage, loss of down, automatic first down, disqualification, ejection, subtraction from the game clock (Rule 10-1-1-b).

## **SECTION 21. Scrimmage**

### **Scrimmage Down**

ARTICLE 1. A scrimmage down is the action between the two teams during a down that begins with a legal snap. *Note:* A try down is a scrimmage down that begins when the referee declares the ball ready for play (Rule 8-3-2-b)

### **Scrimmage Line**

ARTICLE 2. The scrimmage line for each team is established when the ball is ready for play. It is the yard line that defines the vertical plane passing through the point of the ball nearest a team's own goal line.

## **SECTION 22. Shift**

ARTICLE 1. a. A shift is a simultaneous change of position or stance by two or more offensive players after the ball is ready for play before the snap for a scrimmage down (A.R. 7-1-3-I-II and A.R. 7-1-2-I-IV).

- b. The shift ends when all players have been motionless for one full second.
- c. The shift continues if one or more players are in motion before the end of the one second interval.

## **SECTION 23. Snapping the Ball**

ARTICLE 1. a. Legally snapping the ball (a snap) is handing or passing it backward from its position on the ground with a quick and continuous motion of the hand or hands, the ball actually leaving the hand or hands in this motion (Rule 4-1-4).

- b. The snap starts when the ball is moved legally and ends when the ball leaves the snapper's hands; the ball then becomes alive (Rule 4-1-1, A.R. 7-1-5-I-II).
- c. If, during any backward motion of a legal snap, the ball slips from the snapper's hand, it becomes a backward pass and is in play (Rule 4-1-1).
- d. While resting on the ground and before the snap, the long axis of the ball must be at right angles to the scrimmage line (Rule 7-1-3).
- e. Unless moved in a backward direction, the movement of the ball does not start a legal snap. It is not a legal snap if the ball is first moved forward or lifted.
- f. If the ball is touched by Team B during a legal snap, the ball remains dead and Team B is penalized. If the ball is touched by Team B during an illegal snap, the ball remains dead and Team A is penalized (A.R. 7-1-5-I-II).
- g. The snap need not be between the snapper's legs; but to be legal, it must be a quick and continuous backward motion.
- h. The ball must be snapped on or between the hash marks.

## **SECTION 24. Series and Possession Series**

### **Series**

ARTICLE 1. A series comprises up to four consecutive downs that each begins with a snap (Rule 5-1-1).

### **Possession Series**

ARTICLE 2. A possession series is a team's continuous possession of the ball in an extra period (Rule 3-1-3). It may consist of one or more series.

## **SECTION 25. Spots**

### **Enforcement Spot**

ARTICLE 1. An enforcement spot is the point at which the penalty for a foul or the result of a violation is enforced.

### **Previous Spot**

ARTICLE 2. The previous spot is the point at which the ball was last put in play.

### **Succeeding Spot**

ARTICLE 3. The succeeding spot is the point at which the ball is next to be put in play.

### **Dead-Ball Spot**

ARTICLE 4. The dead-ball spot is the point at which the ball became dead.

### **Spot of the Foul**

ARTICLE 5. The spot of the foul is the point at which that foul occurs. If out of bounds between the goal lines, it shall be the intersection of the nearer hash mark and the yard line extended through the spot of the foul. If out of bounds between the goal line and the end line or behind the end line, the foul is in the end zone.

**Out-of-Bounds Spot**

ARTICLE 6. The out-of-bounds spot is the point at which the ball becomes dead by rule because of going or being declared out of bounds.

**Inbounds Spot**

ARTICLE 7. The inbounds spot is the intersection of the nearer hash mark line and the yard line passing through either the dead-ball spot or the spot where a penalty leaves the ball in a side zone.

**Spot Where Run Ends**

ARTICLE 8. The spot where the run ends is the point:

- a. Where the ball is declared dead in player possession.
- b. Where player possession is lost on a fumble.
- c. Where handing of the ball occurs.
- d. Where an illegal forward pass is thrown.
- e. Where a backward pass is thrown.
- f. Where an illegal scrimmage kick is made beyond the line of scrimmage.
- g. Where a return kick occurs.
- h. Where player possession is gained under provisions of the “momentum rule” (Rule 8-5-1-a Exceptions).

**Spot Where Kick Ends**

ARTICLE 9. A scrimmage kick that crosses the neutral zone ends at the spot where it is caught or recovered or where the ball is declared dead by rule (Rule 2-16-1-c).

**Basic Spot**

ARTICLE 10. The basic spot is a benchmark for locating the enforcement spot for penalties governed by the Three-and-One Principle (Rule 2-33). Basic spots for the various categories of plays are given in Rule 10-2-2-d.

**Postscrimmage Kick Spot**

ARTICLE 11. The postscrimmage kick spot serves as the basic spot when postscrimmage kick enforcement applies (Rule 10-2-3).

- a. When the kick ends in the field of play, other than in the special cases given below, the postscrimmage kick spot is the spot where the kick ends.
- b. When the kick ends in Team B's end zone, the postscrimmage kick spot is Team B's 20-yard line.

**Special cases:**

1. On an unsuccessful field goal attempt, if the ball is untouched by Team B after crossing the neutral zone and is declared dead beyond the neutral zone, the postscrimmage kick spot is:
  - (a) The previous spot, if the previous spot is on or outside Team B's 20-yard line; (A.R. 10-2-3-V)
  - (b) Team B's 20-yard line, if the previous spot is between Team B's 20-yard line and its goal line.
2. When Rule 6-3-11 is in effect, the postscrimmage kick spot is Team B's 20-yard line.

3. When Rule 6-5-1-b is in effect, the postscrimmage kick spot is the spot where the receiver first touched the kick.

## **SECTION 26. Tackling**

Tackling is grasping or encircling an opponent with a hand(s) or arm(s).

## **SECTION 27. Team and Player Designations**

### **Teams A and B**

ARTICLE 1. Team A is the team that is designated to put the ball in play, and Team B is the opponent. The teams retain these designations until the ball is next ready for play.

### **Offensive and Defensive Teams**

ARTICLE 2. The offensive team is the team in possession or the team to which the ball belongs; the defensive team is the opposing team.

### **Kicker and Holder**

ARTICLE 3. a. The kicker is any player who punts, drop kicks or place kicks according to rule. That player remains the kicker until they have had a reasonable time to regain their balance.

- b. A holder is a player who controls the ball on the ground or on a kicking tee. During a scrimmage-kick play, that player remains the holder until no player is in position to make the kick or, if the ball is kicked, until the kicker has had a reasonable time to regain their balance.

### **Lineman and Back**

ARTICLE 4. a. Lineman.

1. A lineman is any Team A player legally on their scrimmage line (Rule 2-21-2).
2. A Team A player is legally on the scrimmage line when facing their opponent's goal line with the line of their shoulders approximately parallel thereto and either (a) they are the snapper (Rule 2-27-8) or (b) their head breaks the plane of the line drawn through the waistline of the snapper.
- b. Interior Lineman. An interior lineman is a lineman who is not on the end of their scrimmage line.
- c. Restricted Lineman. A restricted lineman is any interior lineman, or any lineman wearing a number 50-79, whose hand(s) are below the knees.
- d. Back.
  1. A back is any Team A player who is not a lineman and whose head or shoulder does not break the plane of the line drawn through the waistline of the nearest Team A lineman.
  2. A back is also the player in position to receive a hand-to-hand snap.
  3. A lineman becomes a back before the snap when they move to a position as a back and stops.

**Passer**

ARTICLE 5. The passer is the player who throws a forward pass. That player is a passer from the time the ball is released until the pass is complete, incomplete or intercepted, or until they move to participate in the play.

**Player**

ARTICLE 6. a. A player is any one of the participants in the game who is not a substitute or a replaced player and is subject to the rules when inbounds or out of bounds.

- b. An airborne player is a player not in contact with the ground because they have leapt, jumped, dove, launched, etc., in other than normal running action.
- c. A departing player is a player leaving the field, having been replaced by a substitute.

**Runner and Ball Carrier**

ARTICLE 7. a. The runner is a player in possession of a live ball or simulating possession of a live ball.

- b. A ball carrier is a runner in possession of a live ball.

**Snapper**

ARTICLE 8. The snapper is the player who snaps the ball. That player is established as the snapper when they take a position behind the ball and touches or simulates (hand[s] at or below their knees) touching the ball (Rule 7-1-3).

**Substitute**

ARTICLE 9. a. A legal substitute is a replacement for a player or a player vacancy during the interval between downs.

- b. A legal incoming substitute becomes a player when they enter the field of play or end zones and communicates with a teammate or an official, enters the huddle, is positioned in an offensive or a defensive formation, or participates in a play.

**Replaced Player**

ARTICLE 10. A replaced player is one who participated during the previous down, has been replaced by a substitute and has left the field of play and the end zones.

**Player Vacancy**

ARTICLE 11. A player vacancy occurs when a team has fewer than 11 players in the game.

**Disqualified Player and Ejected Player**

ARTICLE 12. a. *Disqualified Player:*

1. A disqualified player is one who is declared ineligible for further participation in the game and is allowed to remain in the team area.
2. A player serving a first-half suspension due to a disqualification in the team's previous game may participate in pre-game warm-up activities.

During the first half they may remain in the team area but may not participate in the first half of the game.

b. *Ejected Player:*

1. An ejected player is one who is declared ineligible for further participation in the game and is not allowed to remain in the team area. This player must leave the playing enclosure under the escort of team personnel before the next play after their ejection. They must remain out of view of the field of play under team supervision for the duration of the game.
2. A player serving a first-half suspension due to an ejection in the team's previous game may participate in pre-game warm-up activities. During the first half they must remain out of view of the field of play under team supervision.

### **Squad Member**

ARTICLE 13. A squad member is part of a group of potential players, in uniform, organized for participation in the ensuing football game or football plays.

### **Defenseless Player**

ARTICLE 14. A defenseless player is one who because of their physical position and focus of concentration is especially vulnerable to injury. When in question, a player is defenseless. *Examples of defenseless players include but are not limited to:*

- a. A player in the act of or just after throwing a pass. This includes an offensive player in a passing posture with focus downfield.
- b. A receiver attempting to catch a forward pass or in position to receive a backward pass, or one who has completed a catch and has not had time to protect themselves or has not clearly become a ball carrier.
- c. A kicker in the act of or just after kicking a ball, or during the kick or the return.
- d. A kick returner attempting to catch or recover a kick, or one who has completed a catch or recovery and has not had time to protect themselves or has not clearly become a ball carrier..
- e. A player on the ground.
- f. A player obviously out of the play.
- g. A player who receives a blind-side block.
- h. A ball carrier already in the grasp of an opponent and whose forward progress has been stopped.
- i. A quarterback any time after a change of possession.
- j. A ball carrier who has obviously given themselves up and is sliding feet-first.

### **Player In Bounds and Out Of Bounds**

ARTICLE 15. a. Out of Bounds

1. A player is out of bounds when any part of their body touches anything other than another player or a game official on or outside a boundary line.

2. An out-of-bounds player who becomes airborne remains out of bounds until they touch the ground in bounds without simultaneously being out of bounds.

b. *In Bounds*

1. An inbounds player is a player who is not out of bounds.
2. An inbounds player who becomes airborne remains in bounds until they are out of bounds.

## **SECTION 28. Tripping**

Tripping is intentionally using the lower leg or foot to obstruct an opponent below the knees (Rule 9-1-2-c).

## **SECTION 29. Timing Devices**

### **Game Clock**

ARTICLE 1. The game clock is any device under the direction of the appropriate official used to time the 60 minutes of the game.

### **Play Clock**

ARTICLE 2. Each stadium shall have a visual play clock at each end of the playing enclosure. The play clock must be capable of counting down from both 40 seconds and 25 seconds. It should automatically default to 40 seconds and start immediately upon being reset by the play-clock operator when any official signals that the ball is dead after a play.

## **SECTION 30. Play Classification**

### **Forward Pass Play**

ARTICLE 1. A legal forward pass play is the interval between the snap and when a legal forward pass is complete, incomplete or intercepted.

### **Free Kick Play**

ARTICLE 2. A free kick play is the action during the interval from the time the ball is legally kicked until it comes into player possession or is declared dead by rule.

### **Scrimmage Kick Play**

ARTICLE 3. A scrimmage kick play is the action during the interval between the snap and when a scrimmage kick comes into player possession or the ball is declared dead by rule.

### **Running Play and Run**

ARTICLE 4. a. A running play is any live-ball action other than that during a free kick play, a scrimmage kick play or a legal forward pass play.

- b. A run is that segment of a running play during which a ball carrier has possession.
- c. If a ball carrier loses possession by a fumble, backward pass or illegal forward pass, the spot where the run ends (Rule 2-25-8) is the yard line where the ball carrier loses possession. The running play includes the run



and the loose-ball action before a player gains or regains possession or the ball is declared dead (A.R. 2-30-4-I and II).

- d. A new running play begins when a player gains or regains possession.

## SECTION 31. Field Areas

### The Field

ARTICLE 1. The field is the area within the limit lines and includes the limit lines and team areas, and the space above it (*Exception:* Enclosures over the field).

### Field of Play

ARTICLE 2. The field of play is the area enclosed by the sidelines and the goal lines.

### End Zone

- ARTICLE 3. a. The end zone at each end of the field is the rectangle defined by the goal line, sidelines and end line.
- b. The goal line and goal line pylons are in the end zone.
  - c. A team's end zone is the one it is defending (A.R. 8-5-1-VII and A.R. 8-6-1-I).

### Playing Surface

ARTICLE 4. The playing surface is the material or substance within the field of play, including the end zones.

### Playing Enclosure

ARTICLE 5. The playing enclosure is that area bounded by the stadium, dome, stands, fences or other structures. (*Exception:* Scoreboards are not considered within the playing enclosure.)

### Side Zone

ARTICLE 6. The side zone is the area between the hash marks and the near sideline.

## SECTION 32. Fighting

ARTICLE 1. Fighting is any attempt by a player, coach or squad member in uniform to strike an opponent in a combative manner unrelated to football. Such acts include, but are not limited to:

- a. An attempt to strike an opponent with the arm(s), hand(s), leg(s) or foot (feet), whether or not there is contact.
- b. An unsportsmanlike act toward an opponent that causes any opponent to retaliate by fighting (Rules 9-2-1 and 9-5-1-a-c).

## SECTION 33. Three-and-One Principle

The Three-and-One Principle of penalty enforcement applies when the penalty statement for a foul does not specify the enforcement spot. Application of this principle is described in Rule 10-2-2-c.

**SECTION 34. Tackle Box**

ARTICLE 1. a. The tackle box is the rectangular area enclosed by the neutral zone, the two lines parallel to the sidelines five yards from the snapper, and Team A's end line. (See Appendix D.)

b. The tackle box disintegrates when the ball leaves it.

---

# RULE 3

## Periods, Time Factors and Substitutions

---

### SECTION 1. Start of Each Period

#### Pregame, First and Third Periods

ARTICLE 1. a. Pregame Warmup. Prior to regular season games, teams must have access to the field for pregame warm-ups until at least 22 minutes before the opening kickoff. This may be altered in advance through written mutual agreement of the teams. Game management personnel are responsible for administering this rule.

- b. When any Squad Member enters the playing enclosure prior to the officials escorting the captains out for the coin toss, the head coach or an assistant coach from that team must be present on the field.
- c. When Squad Members are present within the playing enclosure subsequent to the officials' jurisdiction, they must be wearing their jerseys or have their numerals readily visible. Any player without their numeral readily visible must leave the playing enclosure.
- d. Each half shall start with a kickoff.
- e. Three minutes before the scheduled starting time, the referee shall toss a coin at midfield in the presence of not more than four field captains from each team and another game official, first designating the field captain of the visiting team to call the coin toss. Before the second half, the referee will obtain the teams' second-half options.
- f. During the coin toss, each team shall remain in the area between the nine-yard marks and its sideline or in the team area. The coin toss begins when the field captains leave the nine-yard marks and ends when the captains return to the nine-yard marks.

#### **PENALTY [f]—Five yards from the succeeding spot [S19].**

- g. The winner of the toss shall choose one of the following options:
  - 1. To designate which team shall kick off.
  - 2. To designate which goal line their team shall defend.
  - 3. To defer their team's selection to the second half.
- h. The opponent shall then choose option 1 or 2 above, as available.
- i. If the winner of the toss chooses option 3 above, then after the opponent's choice the winner selects the available option (1 or 2 above).
- j. For the second half the loser of the toss, or the winner who chooses option 3 above, shall choose option 1 or 2 above. The opponent then chooses the remaining available option.

## Second and Fourth Periods

ARTICLE 2. Between the first and second periods and also between the third and fourth periods, the teams shall defend opposite goal lines.

- a. The ball shall be relocated at a spot corresponding exactly, in relation to goal lines and sidelines, to its location at the end of the preceding period.
- b. Possession of the ball, the number of the down and the distance to be gained shall remain unchanged.

## Extra Periods

ARTICLE 3. The NCAA tiebreaker system will be used when a game is tied after four periods. NCAA football-playing rules apply, with the following exceptions:

- a. Immediately after the conclusion of the fourth quarter, officials will instruct both teams to retire to their respective team areas. The officials will assemble at the 50-yard line and review the tiebreaker procedures.
- b. The officials will escort the captains (Rule 3-1-1) to the center of the field for the coin toss. The referee shall toss a coin at midfield in the presence of not more than four field captains from each team and another game official, first designating the field captain of the visiting team to call the coin toss. The winner of the toss may not defer the choice and must choose one of the following options:
  1. Offense or defense, with the offense at the opponent's 25-yard line to start the first possession series.
  2. Which end of the field shall be used for both possession series of that overtime period.
- c. The loser of the toss shall exercise the remaining option for the first extra period and shall have the first choice of the two options for subsequent even-numbered extra periods.
- d. *Definition.* An extra period shall consist of two possession series with each team putting the ball in play by a snap on or between the hash marks on the designated 25-yard line (unless relocated by penalty); this becomes the opponent's 25-yard line. The snap shall be from midway between the hash marks, unless the offensive team selects a different position on or between the hash marks before the ready-for-play signal. After the ready-for-play signal, the ball may be relocated only after a charged team timeout, unless preceded by a Team A foul or offsetting fouls.
- e. *Possession series.* Each team retains the ball during a possession series until it scores or fails to make a first down. The ball remains alive after a change of team possession until it is declared dead. However, Team A may not have a first down if it regains possession after a change of team possession (A.R. 3-1-3-I-IX). Beginning with the third extra period, a team's possession series will be one play for a two-point try from the three-yard line, unless relocated by penalty.

Team A and B designations are the same as defined in Rule 2-27-1.
- f. *Scoring.* The team scoring the greater number of points during the regulation and extra periods shall be declared the winner. There shall be an equal number of possession series, as described in (e) above, in each extra period, unless Team B scores other than on the try. Beginning with the second extra period, teams scoring a touchdown must attempt a two-point

try. Although not illegal, a one-point try attempt by Team A will not result in a score (A.R. 3-1-3-X).

- g. *Fouls after a change of team possession* (A.R. 3-1-3-XI-XIII):
1. Penalties against either team are declined by rule in extra periods. (**Exceptions:** Penalties for flagrant personal fouls, unsportsmanlike conduct fouls, dead-ball personal fouls and live-ball fouls treated as dead-ball fouls are enforced on the succeeding play.)
  2. A score by a team committing a foul during the down is canceled. (**Exception:** Live-ball foul treated as a dead-ball foul.)
  3. If both teams foul during the down and Team B had not fouled before the change of possession, the fouls cancel and the down is not repeated. (**Exceptions:** Penalties for flagrant personal fouls, unsportsmanlike conduct fouls, dead-ball personal fouls and live-ball fouls treated as dead-ball fouls are enforced on the succeeding play.)
- h. *Timeouts.* Each team shall be allowed one timeout for each extra period. (Rule 3-3-7) Timeouts not used during the regulation periods may not be carried over into the extra period(s). Unused extra-period timeouts may not be carried over to other extra periods. Timeouts between periods shall be charged to the succeeding period.

Radio and television timeouts are permitted only between extra periods (first and second, second and third, etc.). Charged team timeouts may not be extended for radio and television purposes. The extra period(s) begins when the ball is first snapped.

In the absence of a media timeout, after the second and fourth extra period, there will be a two minute mandatory break period.

## SECTION 2. Playing Time and Intermissions

### Length of Periods and Intermissions

ARTICLE 1. The total playing time in a collegiate game shall be 60 minutes, divided into four periods of 15 minutes each, with one-minute intermissions between the first and second periods (first half) and between the third and fourth periods (second half) (**Exception:** A one-minute intermission between the first and second and the third and fourth periods may be extended for radio and television timeouts).

- a. No period shall end until the ball is dead and the referee declares the period ended [S14].
- b. The intermission between halves of a regular-season game shall be 20 minutes, unless shortened before the game by mutual agreement of the administrations of both schools. Immediately after the second period ends, the referee should begin the intermission by signaling to start the game clock [S2].

### Timing Adjustments

ARTICLE 2. Before the game starts, playing time and the intermission between halves may be shortened by the referee if they are of the opinion that darkness or other conditions may interfere with the game. The four periods must be of equal length if the game is shortened before its start.

- a. Any time during the game, the playing time of any remaining period or periods may be shortened by mutual agreement of the opposing head coaches and the referee. (A. R. 3-2-2-1)
- b. Timing errors on the game clock may be corrected but only in the period in which they occur.
- c. If the referee has positive knowledge of the elapsed time, they will reset and appropriately start the game clock.
- d. Timing errors on a play clock may be corrected by the referee. The play clock shall start again (Rule 2-29-2).
- e. When the play-clock count is interrupted by circumstances beyond the control of either team (without positive knowledge of game clock elapsed time), a new count shall be started and the game clock shall start per Rule 3-2-4-b.
- f. The 40/25-second clock is not started when the game clock is running with fewer than 40 or 25 seconds, respectively, in a period. The play clock shall be set appropriately and continuously display this time (40 or 25 seconds) and hold.
- g. The game clock should not be stopped if the play clock is started in conflict with paragraph f above.
- h. Timing adjustments for games using Instant Replay are governed by Rule 12-3-6 and 12-3-7.

### Extension of Periods

ARTICLE 3. a. A period shall be extended for an untimed down if one or more of the following occurs during a down in which time expires (A.R. 3-2-3-I-VIII):

1. A penalty is accepted for a live-ball foul(s) (**Exception:** Rule 10-2-5-a). At the option of the offended team, the period is *not* extended if the foul is by the team in possession and the statement of the penalty includes loss of down (A.R. 3-2-3-VIII).
  2. There are offsetting fouls.
  3. An official sounds their whistle inadvertently or otherwise incorrectly signals the ball dead.
- b. Additional untimed downs will be played until a down is free of the circumstances in statements 1, 2 and 3 of Rule 3-2-3-a (above).
- c. If a touchdown is scored during a down in which time in a period expires, the period is extended for the try (**Exception:** Rule 8-3-2-a).

### Timing Devices

ARTICLE 4. a. *Game Clock.* Playing time shall be kept with a game clock that may be either a stop watch operated by the line judge, back judge, field judge or side judge, or a game clock operated by an assistant under the direction of the appropriate judge. The type of game clock shall be determined by the game management. The game clock shall not display tenths of seconds.

- b. *40-Second Clock.* 1. When an official signals that the ball is dead, the play clock shall begin a 40-second count.
2. If the 40-second clock does not start or the count is interrupted for reasons beyond the control of the officials or the play-clock operator (e.g., clock malfunction), the referee shall stop the game clock and

- signal (both palms open in an over-the-head pumping motion) that the play clock should be reset at 40 seconds and started immediately.
3. In the event that the 40-second play clock is running and reads 25 before the ball is ready to be snapped, the referee shall declare a timeout and signal that the play clock be set at 25 seconds. When play is to be resumed, the referee will give the ready-for-play signal [S1] and the play clock shall begin the 25-second count. The game clock will start on the snap unless it had been running when the referee declared a timeout; in that case, it will start on the referee's signal (Rule 3-3-2-f). (A. R. 3-2-4-I and II)
  - c. *25-Second Clock.* If the officials signal the game clock to be stopped for any of the following reasons, the referee shall signal (one open palm in an over-the-head pumping motion) that the clock should be set at 25 seconds:
    1. Penalty administration.
    2. Charged team timeout.
    3. Media timeout.
    4. Injury timeout for a player of the offensive team only. The play clock is set to 40 seconds for an injury to a player of the defensive team.
    5. Measurement.
    6. Team B is awarded a first down other than a free kick.
    7. After a kick down other than a free kick.
    8. Score other than a touchdown (not the try).
    9. Start of each period.
    10. Start of a team's possession series in an extra period.
    11. Instant replay review.
    12. Other administrative stoppage.
    13. An offensive team player's helmet comes completely off through play. The play clock is set to 40 seconds if the helmet comes completely off a player of the defensive team.
 

When play is to be resumed, the referee will give the ready-for-play signal [S1] and the play clock will begin its count.
  - d. *Device Malfunction.* If a visual 40/25-second timing device becomes inoperative, both coaches shall be notified by the referee immediately and both clocks shall be turned off.

### **Minimum Time For A Play After Spiking The Ball**

ARTICLE 5. If the game clock is stopped and will start on the referee's signal with three or more seconds remaining in the quarter, the offense may reasonably expect to throw the ball directly to the ground (Rule 7-3-2-f) and have enough time for another play. With two seconds or one second on the game clock there is enough time for only one play. (A.R. 3-2-5-I)

## **SECTION 3. Timeouts: Starting and Stopping the Clock**

### **Timeout**

ARTICLE 1. a. An official shall signal timeout when the rules provide for stopping the clock or when a timeout is charged to a team or to the referee. Other officials should repeat timeout signals. The referee may declare and

charge themselves with a discretionary timeout for any contingency not elsewhere covered by the rules (A.R. 3-3-1-IV).

- b. When a team's charged timeouts are exhausted and it requests a timeout, the officials shall not acknowledge the request. (Rule 3-3-4).
- c. Once the game begins, players shall not practice with a ball on the field of play or the end zones except during the half-time intermission.

### Starting and Stopping the Clock

ARTICLE 2. a. *Free Kick*. After the ball is free-kicked, the game clock shall be started on an official's signal when the ball is legally touched in the field of play, or when it crosses the goal line after being touched legally by Team B in its end zone. It is subsequently stopped on an official's signal when the ball is dead by rule. (A. R. 3-3-2-VII)

- b. *Scrimmage Down*. When a period begins with a scrimmage down, the game clock shall be started when the ball is legally snapped. On all other scrimmage downs, the game clock shall be started when the ball is legally snapped (Rule 3-3-2-d) or on a prior signal by the referee (Rule 3-3-2-e). The game clock shall not run during a try, during an extension of a period or during an extra period (A.R. 3-3-2-I-IV).
- c. *After a Score*. The game clock shall stop on an official's signal after a touchdown, field goal or safety. It shall be started again as in (a) above unless an accepted penalty erases the score or the down is repeated, in which cases it shall be started when the ball is legally snapped.
- d. *Starts on the Snap*. For each of the following, the game clock is stopped on an official's signal. If the next play begins with a snap, the game clock will start on the snap:
  1. Touchback.
  2. With fewer than two minutes remaining in a half a Team A ball carrier, fumble or backward pass is ruled out of bounds. (**Exception:** After a Team A forward fumble goes out of bounds, the clock starts on the referee's signal.)
  3. Team B is awarded a first down and will next snap the ball (A.R. 3-3-2-V).
  4. A forward pass is ruled incomplete.
  5. A team is granted a charged timeout.
  6. The ball becomes illegal.
  7. A period ends.
  8. A legal kick down ends. (A.R.3-3-2-VI)
  9. A return kick is made.
  10. A scrimmage kick is made beyond the neutral zone.
  11. Team A commits a delay-of-game foul while in a scrimmage-kick formation.
- e. *Starts on the Referee's Signal*. For each of the following reasons, the game clock is stopped on an official's signal. If the next play begins with a snap, the game clock will start on the referee's signal:
  1. Team A is awarded a first down, either through play or by penalty.
  2. A Team A forward fumble goes out of bounds.



3. Other than with fewer than two minutes remaining in a half, a Team A ball carrier, fumble or backward pass is ruled out of bounds.
  4. To complete a penalty (**Exception:** Rule 3-4-4-c).
  5. An injury timeout is allowed for one or more players or an official (A.R. 3-3-5-I-V).
  6. An inadvertent whistle is sounded.
  7. A possible first-down measurement.
  8. Both teams cause a delay in making the ball ready for play (A.R. 3-3-1-III).
  9. A live ball comes into possession of an official.
  10. A head coach requests a conference or challenges an instant-replay decision.
  11. The referee grants a media timeout.
  12. The referee declares a discretionary timeout.
  13. The referee declares a timeout for unfair noise (Rule 9-2-1-b-5 ).
  14. An illegal pass is thrown to conserve time (A.R. 7-3-2-II-VII) (**Exception:** Rule 3-4-4-c).
  15. The referee interrupts the 40/25-second count.
  16. A player's helmet comes completely off through play.
  17. When either team commits a dead-ball foul.
  18. Violation of a rule for mandatory equipment (Rule 1-4-4) or illegal equipment. (Rule 1-4-7)
- f. *Snap Supersedes Referee's Signal.* Whenever one or more incidents that cause the game clock to be started on the referee's signal (Rule 3-3-2-e) occur in conjunction with any that cause it to be started on the snap (Rules 3-3-2-c and 3-3-2-d), it shall be started on the snap. [**Exception:** Rule 3-4-4 (10-second runoff) supersedes this rule, other than when a team is granted a charged timeout. (A.R. 3-3-2-VIII and -IX)]

### Suspending the Game

ARTICLE 3. a. The referee may suspend the game temporarily when conditions warrant such action.

- b. When the game is stopped by actions of a person(s) not subject to the rules, or for any other reasons not specified in the rules, and cannot continue, the referee shall:
1. Suspend play and direct the players to their team areas.
  2. Refer the problem to those responsible for the game's management.
  3. Resume the game when conditions are satisfactory.
- c. If a game is suspended under Rules 3-3-3-a and b before the end of the fourth period and cannot be resumed, there are four possible options:
1. Resume the game at a later date;
  2. Terminate the game with a determined final score;
  3. Forfeit of the game; or
  4. Declare a no contest.

The option that takes effect shall be determined by conference policy if both institutions are members of the same conference. In non-conference competition, the directors of athletics at the participating

institutions or their designees, in consultation with the coaches, must agree on one of the four options. This agreement will include the final score if the game is terminated (Rule 8-1-2).

In the event that the directors of athletics do not reach an agreement, the conference policy of the home team shall be used to determine the outcome.

- d. If a game is suspended under Rules 3-3-3-a and b after four periods of play and cannot be resumed, the game shall be ruled a tie. The final score shall be the score at the end of the last completed period. (Note: If a winner must be determined in a conference playoff game, conference policy shall determine when and where the game will be resumed.)
- e. A suspended game, if resumed, will begin with the same time remaining and under the identical conditions of down, distance, field position and player eligibility.

### **Charged Team Timeouts**

ARTICLE 4. When timeouts are not exhausted, an official shall allow a charged team timeout when requested by any player or head coach when the ball is dead.

- a. Each team is entitled to three charged team timeouts during each half.
- b. After the ball is declared dead and before the snap, a legal substitute may request a timeout if that player is between the nine-yard marks (A.R. 3-3-4-1).
- c. A player who participated during the previous down may request a timeout between the time the ball is declared dead and the snap without being between the nine-yard marks (A.R. 3-3-4-1).
- d. A head coach who is in, or in the vicinity of, their team area or coaching box may request a timeout between the time the ball is declared dead and the next snap.
- e. A player, incoming substitute or head coach may request a head coach's conference with the referee, if the coach believes a rule has been enforced improperly. If the rule enforcement is not changed, the coach's team will be charged a timeout, or a delay penalty if all timeouts have been used.
  1. Only the referee may stop the clock for a head coach's conference.
  2. A request for a head coach's conference or challenge must be made before the ball is snapped or free-kicked for the next play and before the end of the second or fourth period (Rule 5-2-9).
  3. After a head coach's conference or challenge, the full team timeout is granted if charged by the referee.

### **Injury Timeout**

ARTICLE 5. a. In the event of an injured player(s):

1. An official will declare a timeout and the player(s) must leave the game. That player must remain out of the game for at least one down, even if that team is granted a team timeout. When in question, officials will take a timeout for an injured player.
2. The player(s) may not return to the game until receiving approval of professional medical personnel designated by their institution.
3. Medical personnel shall give special attention to players who exhibit signs of a concussion. (See Appendix C).

4. Whenever a participant (player or game official) is bleeding, has blood saturated on the uniform, or has blood on exposed skin, the player or game official shall go to the team area and be given appropriate medical treatment. The player may not return to the game without approval of medical personnel (A.R. 3-3-5-I-VII).
- b. Feigning an injury for any reason is unethical. An injured player must be given full protection under the rules, but feigning an injury is dishonest, unsportsmanlike and contrary to the spirit of the rules. For questionable game action, an institution or conference has the option to consult the national coordinator of football officials who would then facilitate a video review. After the review, the national coordinator will communicate any findings to the conference office for further action. Attention is directed to the statement in The Football Code (Coaching Ethics, Section g).
- c. An injury timeout may follow a charged team timeout.
- d. The referee will declare a timeout for an injured official.
- e. Following a timeout for an injured player of the defensive team, the play clock shall be set at 40 seconds.
- f. *Ten-Second Runoff*: If the player injury is the only reason for stopping the clock (other than that player's helmet or a teammate's helmet coming off, Rule 3-3-9) with less than one minute in the half, the opponent has the option of a 10-second runoff.
  1. The play clock will be set at 40 seconds for an injury to a player of the defensive team and at 25 seconds for an injury to a player of the offensive team (Rule 3-2-4-c-4).
  2. If there is a 10-second runoff the game clock will start on the referee's signal. If there is no 10-second runoff the game clock will start on the snap.
  3. The 10-second runoff may be avoided by the use of a charged team timeout if available.
  4. There is no option of a 10-second runoff if there are injuries to opposing players. (A.R. 3-3-5-VIII and IX)

### Violation Timeouts

ARTICLE 6. For noncompliance with Rule 9-2-2-f, the team will be charged a timeout (Rule 3-4-2-b-2).

### Length of Timeouts

ARTICLE 7. a. A charged full team timeout requested by any player or head coach shall be one minute plus the five-second referee notification and the 25-second play clock interval. (*Exception*: Rule 3-3-4-e-3)

- b. For live-televised games only, a charged team timeout shall be 30 seconds plus the five-second referee notification and the 25-second play clock interval.

However, the head coach may request that one of the allowed three timeouts in each half be a full timeout. This request should be communicated to the referee when the timeout request is made to the officials. The charged team timeout during an extra period (Rule 3-1-3-h) may be a full timeout, at the request of the head coach.

- c. In other than live-televised games, the head coach may request that any charged team timeout be 30 seconds in duration, plus the five-second referee notification and the 25-second play clock interval. The head coach indicates this request visually by touching their hands to their shoulders. The signal must be made promptly after the timeout is requested.
- d. Other timeouts shall be not longer than the referee deems necessary to fulfill the purpose for which they are declared, including a radio or TV timeout, but any timeout may be extended by the referee for the benefit of an injured player (Refer to Appendix A for the guidelines for game officials to use during a serious on-field player injury).
- e. If the team charged with a full team timeout wishes to resume play before the expiration of one minute and its opponent indicates readiness, the referee will declare the ball ready for play.
- f. The length of a referee's timeout depends on the circumstances of each timeout.
- g. Penalty options must be exercised before a team timeout.
- h. The intermission after a safety, try or successful field goal shall be not more than one minute. It may be extended for radio or television.

### **Referee's Notification**

ARTICLE 8. During a full team timeout (Rule 3-3-7-a) the referee shall notify both teams after one minute. Five seconds later the referee shall declare the ball ready for play. During a 30-second team timeout (Rule 3-3-7-b, c) the referee shall notify both teams after 30 seconds. Five seconds later the referee shall declare the ball ready for play.

- a. When a third timeout is charged to a team in either half, the referee shall notify the field captain and head coach of that team.
- b. Unless a visual game clock is the official timepiece, the referee also shall inform each field captain and head coach when approximately two minutes of playing time remain in each half. The referee may order the clock stopped for that purpose.
  - 1. The play-clock count is not interrupted.
  - 2. The clock starts on the snap after the two-minute notification.
- c. If a visual game clock is not the official timing device during the last two minutes of each half, the referee or their representative shall notify each captain and head coach of the time remaining each time the clock is stopped by rule. Also, a representative may leave the team area along the limit line to relay timing information under these conditions.

### **Helmet Comes Off - Timeout**

ARTICLE 9. a. If a player's helmet comes completely off through play, other than as the direct result of a foul by an opponent, the player must leave the game for the next down. The game clock will stop at the end of the down. The player may remain in the game if their team is granted a charged timeout.

- b. When the helmet coming off is the only reason for stopping the clock, other than due to an injury to the player or their teammate (Rule 3-3-5), the following conditions apply (A.R. 3-3-9-I-III):

1. The play clock will be set at 25 seconds if the player is on offense and at 40 seconds if the player is on defense. With one minute or more remaining in either half, the game clock will start on the referee's signal.
  2. *Ten-Second Runoff.* If there is less than one minute in the half the opponent has the option of a 10-second runoff, unless the helmet comes off as the direct result of a foul by the opponent.
  3. If there is a 10-second runoff the game clock will start on the referee's signal. If there is no 10-second runoff the game clock will start on the snap.
  4. The 10-second runoff may be avoided by the use of a charged team timeout, if available.
  5. There is no option for a 10-second runoff if helmets come off opposing players. (A.R. 3-3-9-V)
- c. If the ball carrier's helmet comes off as in paragraph a (above) the ball is dead (Rule 4-1-3-q). If the player is not the ball carrier the ball remains alive, but that player must not continue to participate in the play beyond the immediate action of which they are engaged. Prolonged participation is a personal foul (Rule 9-1-17). By definition such a player is obviously out of the play (Rule 9-1-12-b).
- d. A player who intentionally removes their helmet during the down commits a foul for unsportsmanlike conduct (Rule 9-2-1-a-1-i).

## SECTION 4. Delays/Clock Tactics

### Delaying the Start of a Half

ARTICLE 1. a. Each team shall have its players on the field for the opening play at the scheduled time for the beginning of each half. When both teams refuse to enter the field first for the start of either half, the home team must be the first to enter.

**PENALTY—15 yards from the succeeding spot [S21].**

- b. The home management is responsible for clearing the field of play and end zones at the beginning of each half so the periods may start at the scheduled time. Bands, speeches, presentations, homecoming and similar activities are under the jurisdiction of home management, and a prompt start of each half is mandatory.

**PENALTY—10 yards from the succeeding spot [S21].**

*(Exception:* The referee may waive the penalty for circumstances beyond the control of the home management.)

### Illegal Delay of the Game

ARTICLE 2. a. The officials shall make the ball ready for play consistently throughout the game. The play clock will start its count-down from either 40 seconds or 25 seconds, by rule depending on circumstances. A foul for illegal delay occurs if the play clock is at :00 before the ball is put in play (Rule 3-2-4).

- b. Illegal delay also includes:

1. Deliberately advancing the ball after it is dead.
2. When a team has expended its three timeouts and commits a Rule 9-2-2-f infraction.

3. When a team is not ready to play after an intermission between periods, after a score, after a radio/television/team timeout or anytime the referee orders the ball put in play (A.R. 3-4-2-I).
4. Defensive verbal tactics that disconcert offensive signals (Rule 7-1-5-a-5).
5. Defensive actions designed to cause a false start (Rule 7-1-5-a-4).
6. Putting the ball in play before it is ready for play (Rule 4-1-4).
7. Sideline interference (Rule 9-2-5).
8. Action clearly designed to delay the officials from making the ball ready for play (A.R. 3-4-2-II).

**PENALTY—Dead-ball foul. Five yards from the succeeding spot [S7 and S21].**

### **Unfair Clock Tactics**

ARTICLE 3. The referee has broad authority in the timing of the game.

- a. The referee shall order the game clock or play clock started or stopped whenever either team conserves or consumes playing time by tactics obviously unfair. This includes starting the game clock on the snap if the foul is by the team ahead in the score. As a guideline, referees should consider invoking this rule when the game clock is under five minutes of each half.
- b. If the game clock is stopped to complete a penalty for a foul by the team ahead in the score (or either team if the score is tied) inside the last two minutes of a half, it will start on the snap, at the option of the offended team. The game clock will start on the ready-for-play signal after Team A throws an illegal forward or backward pass to conserve time (Rule 3-3-2-e-14) (A.R. 3-4-3-I-V).

### **10-Second Runoff from Game Clock—Foul**

ARTICLE 4. a. With the game clock running and less than one minute remaining in either half, before a change of team possession if either team commits a foul that causes the clock to stop immediately, the referee will subtract 10 seconds from the game clock at the option of the offended team. The fouls that fall in this category include but are not limited to:

1. Any foul that prevents the snap (e.g., false start, encroachment, defensive offside by contact in the neutral zone, etc.) (A.R. 3-4-4-III);
2. Intentional grounding to stop the clock;
3. Incomplete illegal forward pass;
4. Backward pass thrown out of bounds to stop the clock;
5. Any other foul committed with the intent of stopping the clock.

The offended team may accept the yardage penalty and decline the 10-second runoff. If the yardage penalty is declined the 10-second runoff is declined by rule.

- b. The 10-second rule does not apply if the game clock is not running when the foul occurs or if the foul does not cause the game clock to stop immediately (e.g., illegal formation).
- c. After the penalty is administered, if there is a 10-second runoff, the game clock starts on the referee's signal. If there is no 10-second runoff, the game

clock starts on the snap. **Note:** This rule supersedes Rule 3-3-2-f. (A. R. 3-3-2-VIII and IX)

- d. If the fouling team has a timeout remaining they may avoid the 10-second runoff by using a timeout. In this case the game clock starts on the snap after the timeout.
- e. The 10-second runoff does not apply when there are offsetting fouls. (A.R. 3-4-4-IV)

### **10-Second Runoff Summary**

ARTICLE 5. The following is a summary of when the 10-second runoff process is in effect:

- a. Injury timeout (Rule 3-3-5-f).
- b. Helmet comes off timeout (Rule 3-3-9-b).
- c. Foul (Rule 3-4-4).
- d. Instant replay (Rule 12-3-6-c).

## **SECTION 5. Substitutions**

### **Substitution Procedures**

ARTICLE 1. Any number of legal substitutes for either team may enter the game between periods, after a score or try, or during the interval between downs only for the purpose of replacing a player(s) or filling a player vacancy(ies).

### **Legal Substitutions**

ARTICLE 2. A legal substitute may replace a player or fill a player vacancy provided none of the following restrictions is violated:

- a. No incoming substitute shall enter the field of play or an end zone while the ball is in play.
- b. No player, in excess of 11, shall leave the field of play or an end zone while the ball is in play (A.R. 3-5-2-1).

### **PENALTY [a-b] Live-ball foul. Five yards from the previous spot [S22].**

- c.
  1. An incoming legal substitute must enter the field of play directly from their team area, and a substitute, player or departing player must depart at the sideline nearest their team area and proceed to their team area.
  2. A departing player must immediately leave the field of play, including the end zones. A departing player who leaves the huddle or their position within three seconds, after a substitute becomes a player, is considered to have left immediately.
- d. Substitutes who become players (Rule 2-27-9) must remain in the game for at least one play and replaced players must remain out of the game for at least one play, except during the interval between periods, after a score, or when a timeout is charged to a team or to the referee with the exception of a live-ball out of bounds or an incomplete forward pass (A.R. 3-5-2-III and VII).

### **PENALTY [c-d]—Dead-ball foul: Five yards from the succeeding spot**

- e. When Team A sends in its substitutes, the officials will not allow the ball to be snapped until Team B has been given an opportunity to substitute. While in the process of substitution or simulated substitution, Team A is

prohibited from rushing quickly to the line of scrimmage with the obvious attempt of creating a defensive disadvantage. If the ball is ready for play, the game officials will not permit the ball to be snapped until Team B has placed substitutes in position and replaced players have left the field of play. Team B must react promptly with its substitutes.

**PENALTY—(First Offense)—Dead-ball foul. Delay of game on Team B for not completing its substitutions promptly, or delay of game on Team A for causing the play clock to expire. Five yards from the succeeding spot [S21]. The referee will then notify the head coach that any further use of this tactic will result in an unsportsmanlike conduct foul.**

**PENALTY—(Second or more offense)—Dead-ball foul, team unsportsmanlike conduct. An official will sound their whistle immediately. 15 yards from the succeeding spot [S27].**

### **More Than Eleven Players on the Field**

ARTICLE 3. a. Team A may not break the huddle with more than 11 players nor keep more than 11 players in the huddle or in a formation for more than three seconds. Officials shall stop the action whether or not the ball has been snapped.

**PENALTY—Dead-ball foul. Five yards at the previous spot. [S22]**

b. Team B is allowed to briefly retain more than 11 players on the field to anticipate the offensive formation, but it may not have more than 11 players on the field when the ball is snapped. The infraction is treated as a live-ball foul (A.R. 3-5-3-I-VII).

**PENALTY—Live-ball foul. Five yards at the previous spot. [S22]**



---

# RULE 4

## Ball in Play, Dead Ball, Out of Bounds

---

### SECTION 1. Ball in Play—Dead Ball

#### Dead Ball Becomes Alive

ARTICLE 1. After a dead ball is ready for play, it becomes a live ball when it is legally snapped or legally free-kicked. A ball snapped or free-kicked before it is ready for play remains dead (A.R. 2-16-4-I, A.R. 4-1-4-I and II, A.R. 7-1-3-IV, and A.R. 7-1-5-I and II).

#### Live Ball Becomes Dead

ARTICLE 2. a. A live ball becomes a dead ball as provided in the rules or when an official sounds their whistle (even though inadvertently) or otherwise signals the ball dead (A.R. 4-2-1-II and A.R. 4-2-4-I).

- b. If an official sounds their whistle inadvertently or otherwise signals the ball dead during a down (Rules 4-1-3-k, m and n) (A. R. 4-1-2-1-V):
1. When the ball is in player possession, the team in possession may elect to put the ball in play where declared dead or repeat the down.
  2. When the ball is loose from a fumble, backward pass or illegal pass, the team in possession may elect to put the ball in play where possession was lost or repeat the down (**Exception:** Rule 12-3-3-d).
  3. During a legal forward pass or a free or scrimmage kick, then the ball is returned to the previous spot and the down repeated (**Exception:** Rule 12-3-3-d).
  4. After Team B gains possession on the try or during an extra period, then the try is over or the extra-period possession series is ended.
- c. If a foul or violation occurs during any of the above downs, the penalty or violation privilege shall be administered as in any other play situation if not in conflict with other rules (A.R. 4-1-2-I and II).

#### Ball Declared Dead

ARTICLE 3. A live ball becomes dead and an official shall sound their whistle or declare it dead:

- a. When it goes out of bounds other than a kick that scores a field goal after touching the uprights or crossbar; when a ball carrier is out of bounds; or when a ball carrier is so held that their forward progress is stopped. When in question, the ball is dead (A.R. 4-2-1-II).
- b. When any part of the ball carrier's body, except the hand or foot, touches the ground or when the ball carrier is tackled or otherwise falls and loses possession of the ball as they contact the ground with any part of their

body, except the hand or foot [**Exception:** The ball remains alive when an offensive player has simulated a kick or at the snap is in position to kick the ball held for a place kick by a teammate. The ball may be kicked, passed or advanced by rule] (A.R. 4-1-3-I).

- c. When a touchdown, touchback, safety, field goal or successful try occurs; or when a free kick or a scrimmage kick that is untouched by Team B beyond the neutral zone touches the ground in Team B's end zone (Rules 6-1-7-a, 6-3-9, and A.R. 6-3-9-I).
- d. When, during a try, a dead-ball rule applies (Rule 8-3-2-d-5).
- e. When a player of the kicking team catches or recovers any free kick or a scrimmage kick that has crossed the neutral zone.
- f. When a free kick, scrimmage kick or any other loose ball comes to rest and no player attempts to secure it.
- g. When a scrimmage kick or a free kick is caught or recovered by any Team B player after a valid or invalid fair-catch signal by a Team B player; or when an invalid fair-catch signal is made after a catch or recovery by Team B (Rules 2-8-1 through 3).
- h. When there is a return kick or a scrimmage kick is made beyond the neutral zone.
- i. When a forward pass is ruled incomplete.
- j. When, before a change of team possession on fourth down or a try, a Team A fumble is caught or recovered by a Team A player other than the fumbler (Rules 7-2-2-a and -b and 8-3-2-d-5).
- k. When a live ball not in player possession touches anything inbounds other than a player, a player's equipment, an official, an official's equipment or the ground (inadvertent-whistle provisions apply).
- l. When there is a simultaneous catch or recovery of a live ball.
- m. When the ball becomes illegal while in play (inadvertent-whistle provisions apply).
- n. When a live ball comes into possession of an official (inadvertent-whistle provisions apply).
- o. When a ball carrier simulates placing their knee on the ground.
- p. When an airborne pass receiver of either team is held so that they are prevented from immediately returning to the ground (A.R. 7-3-6-III).
- q. When a ball carrier's helmet comes completely off.
- r. When a ball carrier obviously begins a feet-first slide. Any time a ball carrier simulates or fakes a feet-first slide, the ball should be declared dead by the on-field officials at that point. (A.R. 4-1-3-III and IV)

### Ball Ready for Play

ARTICLE 4. No player shall put the ball in play before it is ready for play (A.R. 4-1-4-I and II).

**PENALTY—Dead-ball foul. Five yards from the succeeding spot [S19].**

### Play-Clock Count

ARTICLE 5. The ball shall be put in play within 40 or 25 seconds after it is made ready for play (Rule 3-2-4), unless, during that interval, play is suspended. If play is suspended, the play-clock count will start again.

**PENALTY—Dead-ball foul for delay of game. Five yards from the succeeding spot [S21].**

## SECTION 2. Out of Bounds

### Player Out of Bounds

ARTICLE 1. a. A player is out of bounds when any part of their person touches anything, other than another player or game official, on or outside a boundary line (Rule 2-27-15) (A.R. 4-2-1-I and II).

- b. An out-of-bounds player who becomes airborne remains out of bounds until they touch the ground in bounds without simultaneously being out of bounds.
- c. A player who touches a pylon is out of bounds.

### Held Ball Out of Bounds

ARTICLE 2. A ball in player possession is out of bounds when either the ball or any part of the ball carrier touches the ground or anything else that is out of bounds, or that is on or outside a boundary line, except another player or game official.

### Loose Ball Out of Bounds

ARTICLE 3. a. A ball not in player control, other than a kick that scores a field goal, is out of bounds when it touches the ground, a player, a game official or anything else that is out of bounds, or that is on or outside a boundary line.

- b. A ball that touches a pylon is out of bounds behind the goal line.
- c. If a live ball not in player possession crosses a boundary line and then is declared out of bounds, it is out of bounds at the crossing point.

### Out of Bounds at Forward Point

ARTICLE 4. a. If a live ball is declared out of bounds and the ball does not cross a boundary line, it is out of bounds at the ball's most forward point when it was declared dead (A.R. 4-2-4-I) (**Exception:** Rule 8-5-1-a, A.R. 8-5-1-I).

- b. A touchdown is scored if the ball is inbounds and has broken the plane of the goal line (Rule 2-12-2) before or simultaneous to the ball carrier going out of bounds.
- c. A receiver who is in the opponent's end zone and contacting the ground is credited with a completion if they reach over the sideline or end line and catch a legal pass.
- d. The most forward point of the ball when declared out of bounds between the goal lines is the point of forward progress. (A.R. 8-2-1-I and A.R. 8-5-1-VII) (**Exception:** When a ball carrier is airborne as they cross the sideline (including a striding runner), forward progress is determined by the position of the ball as it crosses the sideline (A.R. 8-2-1-II-III and V-IX).

---

# RULE 5

## Series of Downs, Line to Gain

---

### SECTION 1. A Series: Started, Broken, Renewed

#### When to Award Series

ARTICLE 1. a. A series (Rule 2-24-1) of up to four consecutive scrimmage downs shall be awarded to the team that is next to put the ball in play by a snap after a free kick, touchback, fair catch, or change in team possession, or to the offensive team in overtime.

- b. A new series shall be awarded to Team A if it is in legal possession of the ball on or beyond its line to gain when the ball is declared dead.
- c. A new series shall be awarded to Team B if, after fourth down, Team A has failed to earn a first down (A.R. 10-1-5-I).
- d. A new series shall be awarded to Team B if Team A's scrimmage kick goes out of bounds or comes to rest and no player attempts to secure it (**Exception:** Rule 8-5-1-a).
- e. A new series shall be awarded to the team in legal possession when the ball is declared dead:
  - 1. If a change of team possession occurs during the down.
  - 2. If a scrimmage kick crosses the neutral zone (**Exceptions:** (1) When the down is repeated; (2) Rule 6-3-7).
  - 3. If an accepted penalty awards the ball to the offended team.
  - 4. If an accepted penalty mandates a first down.
- f. A new series shall be awarded to Team B whenever Team B, after a scrimmage kick, elects to take the ball at a spot of illegal touching (**Exception:** When the down is repeated) (Rules 6-3-2-a and b).

#### Line to Gain

ARTICLE 2. a. The line to gain for a series shall be established 10 yards in advance of the most forward point of the ball; but if this line is in the opponent's end zone, the goal line becomes the line to gain.

- b. The line to gain is established when the ball is made ready for play before the first down of the new series.

#### Forward Progress

ARTICLE 3. a. The most forward point of the ball when declared dead between the end lines shall be the determining point in measuring distance gained or lost by either team during any down (**Exceptions:** 1. Rule 8-5-1, A.R.

8-5-1-I. 2. When an airborne pass receiver of either team completes a catch inbounds after an opponent has driven the receiver backward and the ball is declared dead at the spot of the catch, the forward progress is where the player gained and maintained firm control of the ball.) The ball always shall be placed with its length axis parallel to the sideline before measuring. (Rule 4-1-3-p) (A.R. 5-1-3-I, III, IV and VI, and A.R. 7-3-6-V).

- b. Questionable distance for a first down should be measured without request. Unnecessary measurements to determine first downs shall not be granted.
- c. No request for a measurement shall be granted after the ball is ready for play.

### **Continuity of Downs Broken**

ARTICLE 4. The continuity of a series of scrimmage downs is broken when:

- a. Team possession of the ball changes during a down.
- b. A scrimmage kick crosses the neutral zone.
- c. A kick goes out of bounds.
- d. A kick comes to rest and no player attempts to secure it.
- e. At the end of a down, Team A has earned a first down.
- f. After fourth down, Team A has failed to earn a first down.
- g. An accepted penalty mandates a first down.
- h. There is a score.
- i. A touchback is awarded to either team.
- j. The second period ends.
- k. The fourth period ends.

## **SECTION 2. Down and Possession After a Penalty**

### **Foul During Free Kick Down**

ARTICLE 1. When a scrimmage down follows the penalty for a foul committed during a free kick down, the down and distance established by that penalty shall be first down with a new line to gain.

### **Penalty Resulting in New Series**

ARTICLE 2. It is a new series with a new line to gain:

- a. After a penalty that leaves the ball in possession of Team A beyond its line to gain.
- b. After a penalty that mandates a first down.

### **Foul Before Change of Team Possession**

ARTICLE 3. a. If a penalty is accepted for a foul that occurs between the goal lines before a change of team possession during a down, the ball belongs to Team A. The down shall be repeated unless the penalty also involves loss of a down, mandates a first down, or leaves the ball on or beyond the line to gain (*Exceptions:* Rules 8-3-3-b-1, 10-2-3, 10-2-4, and 10-2-5). (A.R. 10-2-3-I)

- b. If the penalty involves loss of a down, the down shall count as one of the four in that series.

**Foul After Change of Team Possession**

ARTICLE 4. If a penalty is accepted for a foul that occurs during a down after a change of team possession, the ball belongs to the team in possession when the foul occurred. The down and distance established by any such penalty shall be first down with a new line to gain (*Exception:* Rule 10-2-5-a).

**Penalty Declined**

ARTICLE 5. If a penalty is declined, the number of the next down shall be whatever it would have been if the foul had not occurred.

**Foul Between Downs**

ARTICLE 6. After a distance penalty incurred between downs, the number of the next down shall be the same as that established before the foul occurred, unless enforcement for a foul by Team B leaves the ball on or beyond the line to gain or a penalty mandates a first down (Rule 9-1) (A.R. 5-2-6-I and A.R. 10-1-5-I-III).

**Foul Between Series**

ARTICLE 7. a. The penalty for any dead-ball foul (including live-ball fouls treated as dead-ball fouls) that occurs after a series ends and before the ball is ready for play shall be completed before the line to gain is established.

b. The penalty for any dead-ball foul that occurs after the ball is ready for play shall be completed after the line to gain is established (A.R. 5-2-7-I-V).

**Fouls by Both Teams**

ARTICLE 8. If offsetting fouls occur during a down, that down shall be repeated (Rule 10-1-4 Exceptions) (A.R. 10-1-4-III-VI, VII).

**Rule Decisions Final**

ARTICLE 9. No rule decision may be changed after the ball is next legally snapped, legally free-kicked or the second or fourth periods have ended (Rules 3-2-1-a, 3-3-4-e-2 and 11-1). (*Exception:* The number of a down may be corrected any time within that series of downs or before the ball is legally next put in play after that series.)

---

# RULE 6

## Kicks

---

### SECTION 1. Free Kicks

#### Restraining Lines

ARTICLE 1. For any free kick formation, the kicking team's restraining line shall be the yard line through the most forward point from which the ball shall be kicked, and the receiving team's restraining line shall be the yard line 10 yards beyond that point. Unless relocated by a penalty, the kicking team's restraining line on a kickoff shall be its 35-yard line, and for a free kick after a safety, its 20-yard line.

#### Free Kick Formation

ARTICLE 2. a. A ball from a free kick formation must be kicked legally and from some point on Team A's restraining line (*Exception:* Rule 6-1-2-c-4) and on or between the hash marks. The referee will declare the ball ready for play when the officials are in position after the kicker has received the ball. After the ready-for-play signal, the ball may only be relocated after a charged timeout or during a subsequent kick.

**PENALTY—Dead ball foul. Illegal kick. Five yards from the succeeding spot [S7 and S19]. (A.R. 6-1-2-I).**

- b. After the ball has been made ready for play, all players on the kicking team except the kicker must be no more than five yards behind their restraining line. A player satisfies this rule when one foot is on or beyond the line five yards behind the restraining line. If one player is more than five yards behind the restraining line and any other player kicks the ball, it is a foul for an illegal formation. (A.R. 6-1-2-VII)
- c. When the ball is kicked (A.R. 6-1-2-I-IV):
  1. Each Team A player, except the holder and kicker of a place kick, must be behind the ball (A.R. 6-1-2-V) [S18].
  2. All Team A players must be inbounds [S19].
  3. At least four Team A players must be on each side of the kicker [S19]. (AR 6-1-2-II-IV)
  4. After a safety, when a punt or drop kick is used, the ball may be kicked from behind the kicking team's restraining line. If a yardage penalty for a live-ball foul is enforced from the previous spot, administration is from the 20-yard line, unless the kicking team's restraining line has been relocated by a previous penalty [S18 or appropriate signal].
  5. All players of Team A must have been between the nine-yard marks after the ready-for-play signal [S19].

**PENALTY [b-c5]—Live-ball foul. Five yards from the previous spot, or five yards from the spot where the subsequent dead ball belongs to Team B, or from the spot where the ball is placed after a touchback [S18 or S19] (A.R. 6-1-2-VI).**

6. All Team B players must be inbounds [S19].
7. All Team B players must be behind their restraining line [S18].

**PENALTY [c6-c7]—Live-ball foul. Five yards from the previous spot [S18 or S19].**

- d. After the ball is ready for play and for any reason falls from the tee, Team A shall not kick the ball and the official shall sound their whistle immediately.

### **Touching and Recovery of a Free Kick; Illegal Touching**

ARTICLE 3. a. No Team A player may touch a free-kicked ball until after:

1. It touches a Team B player (**Exception:** Rules 6-1-4 and 6-5-1-b);
2. It breaks the plane of and remains beyond Team B's restraining line (**Exception:** Rule 6-4-1) (A.R. 2-12-5-I); or
3. It touches any player, the ground, an official or anything else beyond Team B's restraining line.

Thereafter, all players of Team A become eligible to touch, recover or catch the kick.

- b. Any other touching by Team A is *illegal touching*, a violation that, when the ball becomes dead, gives the receiving team the privilege of taking the ball at the spot of the violation.
- c. If there is an accepted penalty for a live-ball foul by either team, or if there are offsetting fouls, the illegal touching privilege is canceled (A.R. 6-1-3-I).
- d. Illegal touching in Team A's end zone is ignored.

### **Forced Touching Disregarded**

ARTICLE 4. a. A player blocked by an opponent into a free kick is not, while inbounds, deemed to have touched the kick. (A. R. 2-11-4-I)

- b. An inbounds player touched by a ball either batted or illegally kicked by an opponent is not deemed to have touched the ball. (Rule 2-11-4-c)

### **Free Kick at Rest**

ARTICLE 5. If a free kick comes to rest inbounds and no player attempts to secure it, the ball becomes dead and belongs to the receiving team at the dead-ball spot.

### **Free Kick Caught or Recovered**

ARTICLE 6. a. If a free kick is caught or recovered by a player of the receiving team, the ball continues in play (**Exceptions:** Rules 4-1-3-g, 6-1-7, and 6-5-1 and 2). If caught or recovered by a player of the kicking team, the ball becomes dead. The ball belongs to the receiving team at the dead-ball spot, unless the kicking team is in legal possession when the ball is declared dead. In the latter case, the ball belongs to the kicking team.

- b. When opposing players, each eligible to touch the ball, simultaneously recover a rolling kick or catch a free kick, the simultaneous possession makes the ball dead.



- c. A kick declared dead in joint possession is awarded to the receiving team.

### **Ball Dead in End Zone**

ARTICLE 7. a. When a free kick untouched by Team B touches the ground on or behind Team B's goal line, the ball becomes dead and belongs to Team B.

- b. If the result of the free kick is a touchback (Rule 8-6) for Team B, they will put the ball in play at their 25-yard line.

### **Fouls by Kicking Team**

ARTICLE 8. Penalties for all fouls by the kicking team during a free kick play other than kick-catch interference (Rule 6-4) may be enforced at the previous spot with the down repeated or at the spot where the subsequent dead ball belongs to Team B, at the option of Team B.

### **Foul Against Kicker**

ARTICLE 9. The kicker of a free kick may not be blocked until they have advanced five yards beyond the restraining line or the kick has touched a player, an official or the ground. (Rule 9-1-16-c)

**PENALTY—15 yards from the previous spot [S40].**

### **Illegal Wedge Formation**

ARTICLE 10. a. A wedge is defined as two or more players aligned shoulder to shoulder within two yards of each other.

- b. Free-kick down only: After the ball has been kicked, it is illegal for two or more members of the receiving team intentionally to form a wedge for the purpose of blocking for the ball carrier. This is a live-ball foul, whether or not there is contact between opponents.

**PENALTY—Noncontact foul. 15 yards, spot of the foul, or 15 yards, spot where the subsequent dead ball belongs to Team B if this is behind the spot of the foul. 15 yards, previous spot with the down repeated if the subsequent dead ball belongs to Team A. [S27]**

- c. Formation of the wedge is not illegal when the kick is from an obvious onside kick formation.
- d. There is no foul if the play results in a touchback, a foul for free kick out of bounds or fair catch.

### **Player Out Of Bounds**

ARTICLE 11. A Team A player who goes out of bounds during a free kick play may not return inbounds during the down (*Exception:* This does not apply to a Team A player who is blocked out of bounds and returns in-bounds immediately).

**PENALTY—Live-ball foul. Five yards from the previous spot, or five yards from the spot where the subsequent dead ball belongs to Team B, or from the spot where the ball is placed after a touchback [S19]**

### Eligibility to Block

ARTICLE 12. No Team A player may block an opponent until Team A is eligible to touch a free-kicked ball. (A.R. 6-1-3-II)

**PENALTY—Live-ball foul. Five yards from the previous spot, or five yards from the spot where the subsequent dead ball belongs to Team B, or from the spot where the ball is placed after a touchback [S19].**

## SECTION 2. Free Kick Out of Bounds

### Kicking Team

ARTICLE 1. If a free kick goes out of bounds between the goal lines untouched by an inbounds player of Team B, it is a foul (A.R. 6-2-1-I-II and 4-2-1-III).

**PENALTY—Live-ball foul. Five yards from the previous spot; or five yards from the spot where the subsequent dead ball belongs to Team B; or the receiving team may put the ball in play 30 yards beyond Team A's restraining line at the hash mark [S19].**

### Receiving Team

ARTICLE 2. If a free kick goes out of bounds between the goal lines, the ball belongs to the receiving team at the hash mark. If a free kick goes out of bounds behind the goal line, the ball belongs to the team defending that goal line (A.R. 6-2-2-I-IV).

## SECTION 3. Scrimmage Kicks

### Behind the Neutral Zone

ARTICLE 1. a. A scrimmage kick that fails to cross the neutral zone continues in play. All players may catch or recover the ball behind the neutral zone and advance it (A.R. 6-3-1-I-III).

b. The blocking of a scrimmage kick by an opponent of the kicking team who is not more than three yards beyond the neutral zone is considered to have occurred within or behind that zone (Rule 2-11-5).

### Beyond the Neutral Zone

ARTICLE 2. a. No inbounds player of the kicking team shall touch a scrimmage kick that has crossed the neutral zone before it touches an opponent. This is *illegal touching*, a violation that, when the ball becomes dead, gives the receiving team the privilege of taking the ball at the spot of the violation (**Exception:** Rule 6-3-4) (A.R. 2-12-2-I and A.R. 6-3-2-I).

b. This privilege is canceled if there is an accepted penalty for a live-ball foul by either team (A.R. 6-3-2-I-IV, A.R. 6-3-11-I-III and A.R. 10-1-4-VII).

c. The privilege is canceled if there are offsetting fouls.

d. Illegal touching on a try, in extra periods, or in Team A's end zone is ignored.

### **All Become Eligible**

ARTICLE 3. When a scrimmage kick that has crossed the neutral zone touches a player of the receiving team who is inbounds, any player may catch or recover the ball (Rule 6-3-1-b) (*Exceptions:* Rules 6-3-4 and 6-5-1-b).

### **Forced Touching Disregarded**

ARTICLE 4. a. A player blocked by an opponent into a scrimmage kick that has crossed the neutral zone shall not, while inbounds, be deemed to have touched the kick (A.R. 6-3-4-I-V and 2-11-4-I).

b. An inbounds player touched by a ball either batted or illegally kicked by an opponent is not deemed to have touched the ball (A.R. 6-3-4-II). (Rule 2-11-4-c)

### **Catch or Recovery by Receiving Team**

ARTICLE 5. If a player of the receiving team catches or recovers a scrimmage kick, the ball continues in play (*Exceptions:* Rules 4-1-3-g, 6-3-9, 6-5-1 and 2) (A.R. 8-4-2-V).

### **Catch or Recovery by Kicking Team**

ARTICLE 6. a. If a player of the kicking team catches or recovers a scrimmage kick that has crossed the neutral zone, the ball becomes dead (A.R. 6-3-1-IV). The ball belongs to the receiving team at the dead-ball spot, unless the kicking team is in legal possession when the ball is declared dead. In the latter case, the ball belongs to the kicking team. (*Exception:* Rule 8-4-2-b).

b. If opposing players who are each eligible to touch the ball simultaneously catch or recover a scrimmage kick, the simultaneous possession makes the ball dead. A kick declared dead in joint possession of opposing players is awarded to the receiving team (Rules 2-4-4 and 4-1-3-l).

### **Out of Bounds Between Goal Lines or at Rest Inbounds**

ARTICLE 7. If a scrimmage kick goes out of bounds between the goal lines, or if it comes to rest inbounds and no player attempts to secure it, the ball becomes dead and belongs to the receiving team at the dead-ball spot (*Exception:* Rule 8-4-2-b).

### **Out of Bounds Behind Goal Line**

ARTICLE 8. If a scrimmage kick (other than one that scores a field goal) goes out of bounds behind a goal line, the ball becomes dead and belongs to the team defending that goal line (Rule 8-4-2-b).

### **Touching Ground On or Behind Goal Line**

ARTICLE 9. If a scrimmage kick untouched by Team B beyond the neutral zone touches the ground on or behind Team B's goal line, the ball becomes dead and belongs to Team B. (Rule 8-4-2-b) (A.R. 6-3-9-I-II).

### **Legal and Illegal Kicks**

ARTICLE 10. a. A legal scrimmage kick is a punt, drop kick or place kick made according to rule.

b. A return kick is an illegal kick, a live-ball foul that causes the ball to become dead (Rule 2-16-8).

**PENALTY—For a return kick (live-ball foul): Five yards from the spot of the foul [S31].**

- c. A scrimmage kick made when the kicker's entire body is beyond the neutral zone is an illegal kick, a live-ball foul that causes the ball to become dead.

**PENALTY—For an illegal kick beyond the neutral zone (live-ball foul): Five yards from the previous spot and loss of down [S31 and S9].**

- d. No device or material may be used to mark the spot of a scrimmage place kick or elevate the ball. This is a live-ball foul at the snap.

**PENALTY—Five yards from the previous spot [S19].**

### **Loose Behind the Goal Line**

ARTICLE 11. If a scrimmage kick untouched by Team B after crossing the neutral zone is batted in Team B's end zone by a player of Team A, it is a violation for illegal touching (Rule 6-3-2). The spot of the violation is Team B's 20-yard line. This is a special case of batting in the end zone and is not a foul. (A.R. 6-3-11-I-V and A.R. 2-12-2-I).

### **Out-of-Bounds Player**

ARTICLE 12. No Team A player who goes out of bounds during a scrimmage kick play may return inbounds during the down (*Exception:* This does not apply to a Team A player who is blocked out of bounds and attempts to return inbounds immediately).

**PENALTY—Live-ball foul. Five yards from the previous spot or if the scrimmage kick crosses the neutral zone, five yards from the spot where the subsequent dead ball belongs to Team B [S19].**

### **Fouls by Kicking Team**

ARTICLE 13. Penalties for all fouls by the kicking team other than kick-catch interference (Rule 6-4) during a scrimmage kick play (except field-goal attempts) in which the ball crosses the neutral zone may be enforced by rule either at the previous spot as the basic spot with the down repeated (*Exception:* Penalty option is a safety for fouls in Team A's end zone.) or at the spot where the subsequent dead ball belongs to Team B, at the option of Team B. (A.R. 6-3-13-I-III)

### **Defensive Linemen on Scrimmage Kick Plays**

ARTICLE 14. a. If Team A is in a scrimmage kick formation at the snap, any Team B player within one yard of the line of scrimmage must be aligned completely outside the frame of the body of the snapper at the snap (A.R. 6-3-14-I and II).

- b. If Team A is in a formation to attempt a place kick (field goal or try) it is illegal for three Team B players on their line of scrimmage inside the blocking zone to align shoulder-to-shoulder and move forward together after the snap with primary contact against a single Team A player (A.R. 6-3-14-III and IV).

**PENALTY—Live-ball foul. Five yards, previous spot. [S19]**

## SECTION 4. Opportunity To Catch a Kick

### Interference With Opportunity

ARTICLE 1. a. If an inbounds player of the receiving team is located where they could catch a free kick or a scrimmage kick that has crossed the neutral zone, and if the player is attempting to do so, they must be given an unimpeded opportunity to catch the kick (A.R. 6-3-1-III, A.R. 6-4-1-V, VI and IX).

- b. It is an interference foul if, before the receiver touches the ball, a Team A player enters the area defined by the width of the receiver's shoulders and extending one yard in front of him. When in question it is a foul. (A.R. 6-4-1-X-XIII)
- c. This protection ends when the kick touches the ground (**Exception:** Free kick, par. f below), when any player of Team B muffs or touches a scrimmage kick beyond the neutral zone, or when any player of Team B muffs or touches a free kick in the field of play or in the end zone (**Exception:** Rule 6-5-1-b) (A.R. 6-4-1-IV).
- d. If interference with a potential receiver is the result of a player being blocked by an opponent, it is not a foul.
- e. It is an interference foul if the kicking team contacts the potential receiver before, or simultaneous to, their first touching the ball (A.R. 6-4-1-II, III, and VIII). When in question, it is an interference foul.
- f. During a free kick a player of the receiving team in position to receive the ball has the same kick-catch and fair-catch protection whether the ball is kicked directly off the tee or is immediately driven to the ground, strikes the ground once and goes into the air in the manner of the ball kicked directly off the tee.
- g. If contact by Team A is deemed to be a targeting foul (Rules 9-1-3 and 9-1-4) or any other personal foul that interferes with the receiver's opportunity to catch a kick, it may be ruled either as interference or as a targeting or personal foul. The 15-yard penalty is enforced at the spot where the dead ball belongs to Team B or at the spot of the foul, at the option of Team B.

**PENALTY [a-g]—For foul between the goal lines (other than a foul behind the B-25 on a free kick): Receiving team's ball, first down, 15 yards beyond the spot of the foul for an interference foul [S33].**

**For a foul on a free kick play behind the B-25-yard line against a player who has given a valid fair catch signal: Penalize from the B-25 [S33].**

**For foul behind the goal line: Award a touchback and penalize from the succeeding spot [S33].**

**Flagrant offenders shall be ejected or disqualified [S47].**

## SECTION 5. Fair Catch

### Dead Where Caught

ARTICLE 1. a. If a Team B player makes a fair catch, the ball becomes dead where caught and belongs to Team B at that spot. [**Exception:** If a Team B

player makes a fair catch of a free kick behind Team B's 25-yard line, the ball belongs to Team B at its own 25-yard line.

The next snap shall be from midway between the hashmarks, unless a different position on or between the hashmarks is selected by the team designated to put the ball in play before the play clock is at 25 seconds or before any subsequent ready-for-play signal. After the play clock is at 25 seconds or any subsequent ready-for-play signal, the ball may be relocated only after a charged team timeout unless preceded by a Team A foul or offsetting fouls.]

- b. If a Team B player makes a valid fair catch signal, the unimpeded opportunity to catch a free or scrimmage kick continues if this player muffs the kick and still has an opportunity to complete the catch. If that player (or another Team B player) subsequently catches the kick, the ball belongs to Team B where the player making the signal first touched it. This protection terminates when the kick touches the ground. (A.R. 6-5-1-I-II).
- c. Rules pertaining to a fair catch apply only when a scrimmage kick crosses the neutral zone or during free kicks.
- d. The purpose of the fair catch provision is to protect the receiver who, by using the fair catch signal, agrees they or a teammate will not advance after the catch (A.R. 6-5-5-III).
- e. The ball shall be put in play by a snap by the receiving team at the spot of the catch if the ball is caught (**Exceptions:** Rules 6-5-1-a, 6-5-1-b, 7-1-3 and 8-6-1-b).

### No Advance

ARTICLE 2. No Team B player shall carry a caught or recovered ball more than two steps in any direction after any Team B player gives a valid or invalid fair catch signal (A.R. 6-5-2-I-III).

**PENALTY—Dead-ball foul, delay of game. Five yards from the succeeding spot [S7 and S21].**

### Invalid Signals: Catch or Recovery

ARTICLE 3. a. A catch after an invalid signal is not a fair catch, and the ball is dead where caught or recovered. (**Exception:** During a free kick, if a Team B receiver gives any waving signal that does not meet all of the requirements of a valid fair catch signal, and subsequently catches the ball behind the B-25 yard line the ball belongs to Team B at its own 25-yard line).

- b. If the signal follows a catch or recovery, the ball is dead when the signal is first given (A.R. 6-5-1-I).
- c. Invalid signals beyond the neutral zone apply only to Team B.
- d. An invalid signal beyond the neutral zone is possible only when the ball has crossed the neutral zone (Rule 2-16-7) (A.R. 6-5-3-I).

### Illegal Block or Contact

ARTICLE 4. A player of Team B who has made a valid or invalid signal for a fair catch and does not touch the ball shall not block or foul an opponent during that down (A.R. 6-5-4-I and II).

**PENALTY—Free kick: Receiving team's ball 10 yards from the spot of the foul [S40]. Scrimmage kick: 10 yards, postscrimmage kick enforcement [S40]. If a Personal Foul is committed in**

**conjunction with this action, the penalty is 15 yards and  
flagrant offenders shall be ejected or disqualified.**

### **No Tackling**

ARTICLE 5. No player of the kicking team shall tackle or block an opponent who has completed a fair catch. Only the player making a fair catch signal has this protection (A.R. 6-5-5-I and III).

**PENALTY—Dead-ball foul. Receiving team's ball 15 yards from the succeeding spot [S7 and S38].**

---

# RULE 7

## Snapping and Passing the Ball

---

### SECTION 1. The Scrimmage

#### Starting With a Snap

ARTICLE 1. a. The ball shall be put in play by a legal snap unless the rules provide for a legal free kick (A.R. 4-1-4-I and II).

b. No player shall put the ball in play before it is ready for play (Rule 4-1-4 and A.R. 4-1-4-I and II).

**PENALTY [a-b]—Dead-ball foul. Five yards from the succeeding spot [S7 and S19].**

c. The ball may not be snapped in a side zone (Rule 2-31-6). If the starting point for any scrimmage down is in a side zone, the ball shall be transferred to the hash mark.

#### Shift and False Start

ARTICLE 2. a. *Shift*. After a huddle (Rule 2-14) or shift (Rule 2-22-1) and before the snap, all Team A players must come to an absolute stop and remain stationary in their positions without movement of the feet, body, head or arms for at least one full second before the ball is snapped. (A.R. 7-1-2-I).

b. *False Start*. Each of the following is a false start by Team A if it occurs prior to the snap after the ball is ready for play and all players are in scrimmage formation:

1. Any movement by one or more players that simulates the start of a play.
2. The snapper moving to another position.
3. A restricted lineman (Rule 2-27-4) moving their hand(s) or making any quick movement. [**Exceptions:** 1. It is not a false start if a Team A lineman immediately reacts when threatened by a Team B player in the neutral zone (Rule 7-1-5-a-2) (A.R. 7-1-3-V) 2. Rule 7-1-3-a-3].
4. An offensive player making any quick, jerky movement before the snap, including but not limited to:
  - (a) A lineman moving their foot, shoulder, arm, body or head in a quick, jerky motion in any direction.
  - (b) The snapper shifting or moving the ball, moving their thumb or fingers, flexing their elbows, jerking their head, or dipping their shoulders or buttocks.
  - (c) The quarterback making any quick, jerky movement that simulates the beginning of a play.



- (d) A back simulating receiving the ball by making any quick, jerky movement that simulates the beginning of a play.
5. The offensive team never coming to a one-second stop prior to the snap after the ball is ready for play (A.R. 7-1-2-IV). This is an illegal shift that converts to a false start.

### Offensive Team Requirements—Prior to the Snap

ARTICLE 3. Each of the following (a-d) is a dead-ball foul. Officials should blow the whistle and not allow the play to continue. After the ball is ready for play and before it is snapped:

- a. *Snapper*. The snapper (Rule 2-27-8):
1. May not move to a different position nor have any part of their body beyond the neutral zone;
  2. May not lift the ball, move it beyond the neutral zone or simulate the start of a play;
  3. May take their hand(s) off the ball, but only if this does not simulate the start of a play.
- b. *Nine-Yard Marks*.
1. Each Team A substitute must have been between the nine-yard marks. Team A players who participated in the previous down must have been between the nine-yard marks after the previous down and before the next snap (A.R. 3-3-4-I).
  2. All Team A players must have been between the nine-yard marks after a charged team timeout, an injury timeout, a media timeout or the end of a period.
- c. *Encroachment*. Once the snapper is established, no other Team A player may be in or beyond the neutral zone [**Exceptions:** (1) Substitutes and departing players; and (2) offensive players in a scrimmage kick formation who break the neutral zone with their hand(s) to point at opponents].
- d. *False Start*. No Team A player may commit a false start (Rule 7-1-2-b) or contact an opponent (A.R. 7-1-3-III).

**PENALTY—[a-d] Dead-ball foul: Five yards from the succeeding spot. [S7 and S19 or S20].**

### Offensive Team Requirements—At the Snap

ARTICLE 4. Violation of each of the following (a-c) is a live-ball foul; the play is allowed to continue.

- a. *Formation*. At the snap Team A must be in a formation that meets these requirements:
1. All players must be inbounds.
  2. All players must be either linemen or backs (Rule 2-27-4, A.R. 7-1-4-VIII).
  3. At least five linemen must wear jerseys numbered 50 through 79 (**Exception:** When the snap is from a scrimmage kick formation, par. 5 below.)
  4. No more than four players may be backs.

5. In a scrimmage kick formation at the snap (Rule 2-16-10) Team A may have fewer than five linemen numbered 50-79, subject to the following conditions:
  - (a) Any and all linemen not numbered 50-79 who are ineligible receiver(s) by position become exceptions to the numbering rule when the snapper is established.
  - (b) Any and all such numbering-exception players must be on the line and may not be on the end of the line. Otherwise, Team A commits a foul for an illegal formation.
  - (c) Any and all such players are exceptions to the numbering rule throughout the down and remain ineligible receivers unless they become eligible under Rule 7-3-5 (forward pass touched by an official or a Team B player).

The conditions in 5(a)–5(c) are no longer in effect if prior to the snap a period ends or there is a timeout charged to the referee or one of the teams.

b. *Man in Motion.*

1. One back may be in motion, but that back may not be moving toward their opponent's goal line.
2. The player who goes in motion may not start from the line of scrimmage unless they first become a back and come to a complete stop.
3. A player in motion at the snap must have satisfied the one-second rule—i.e., that player may not start their motion before any shift has ended (Rule 2-22-1-c).

c. *Illegal Shift.* At the snap, Team A may not execute an illegal shift (Rule 7-1-2-a). (A.R. 7-1-3-I-II).

**PENALTY [a-c]—Live-ball foul: Five yards from the previous spot [S19 or S20]. For live-ball fouls occurring when or after the snap starts during scrimmage kick plays other than field goal plays: Five yards from the previous spot or if the kick crosses the neutral zone, five yards from the spot where the subsequent dead ball belongs to Team B [S19 or S20].**

### Defensive Team Requirements

ARTICLE 5. The defensive team requirements are as follows:

- a. Each of the following (1-5) is a dead ball foul. Officials should blow the whistle and not allow the play to continue. After the ball is ready for play and before the ball is snapped:
  1. No player may touch the ball except when moved illegally as in Rule 7-1-3-a-1, nor may any player contact an opponent or in any other way interfere with him. (A.R. 7-1-5-I-II).
  2. No player may enter the neutral zone causing an offensive lineman to react immediately or commit any other dead-ball offside foul (Rules 2-18-2 and 7-1-2-b-3-Exception) (A.R. 7-1-3-V and A.R. 7-1-5-III).
  3. No player may cross the neutral zone and without making contact continue their charge toward any back.

**PENALTY [1-3]—Dead-ball foul, offside. Five yards from the succeeding spot [S18].**

4. Player(s) aligned in a stationary position within one yard of the line of scrimmage may not make quick, abrupt or exaggerated actions that are not part of normal defensive player movement (A.R. 7-1-5-IV).
5. No player shall use words or signals that disconcert opponents when they are preparing to put the ball in play. No player may call defensive signals that simulate the sound or cadence of, or otherwise interfere with, offensive starting signals.

**PENALTY [4-5]—Dead-ball foul, delay of game. Five yards from the succeeding spot [S21].**

- b. When the snap starts:
  1. No player may be in or beyond the neutral zone at the snap.
  2. All players must be inbounds.

**PENALTY—Live-ball foul. Five yards from the previous spot [S18].**

### **Handing the Ball Forward**

ARTICLE 6. No player may hand the ball forward except during a scrimmage down as follows:

- a. A Team A back may hand the ball forward to another back only if both are behind their scrimmage line and the player handing the ball forward has not had their entire body beyond the neutral zone.
- b. A Team A back behind their scrimmage line may hand the ball forward to a teammate who is on their scrimmage line at the snap, provided that teammate leaves their line position by a movement of both feet that faces that player toward their team's end line and is at least two yards behind their scrimmage line when receiving the ball (A.R. 7-1-6-1).

**PENALTY—Five yards from the spot of the foul; also loss of a down if by Team A before team possession changes during a scrimmage down [S35 and S9].**

### **Planned Loose Ball**

ARTICLE 7. A Team A player may not advance a planned loose ball in the vicinity of the snapper.

**PENALTY—Five yards from the previous spot and loss of down [S19 and S9].**

## **SECTION 2. Backward Pass and Fumble**

### **During Live Ball**

ARTICLE 1. A ball carrier may hand or pass the ball backward at any time, except to throw the ball intentionally out of bounds to conserve time.

**PENALTY—Five yards from the spot of the foul; also loss of down if by Team A before team possession changes during a scrimmage down (A.R. 3-4-3-III) [S35 and S9].**

## Caught or Recovered

ARTICLE 2. a. When a backward pass or fumble is caught or recovered by any inbounds player, the ball continues in play (A.R. 2-23-1-I).

### *Exceptions:*

1. Rule 8-3-2-d-5 (Team A fumble on the try).
  2. On fourth down before a change of team possession, when a Team A fumble is caught or recovered by a Team A player other than the fumbler, the ball is dead. If the catch or recovery is beyond the spot of the fumble, the ball is returned to the spot of the fumble. If the catch or recovery is behind the spot of the fumble, the ball remains at the spot of the catch or recovery.
- b. When a backward pass or fumble is caught or recovered simultaneously by opposing players, the ball becomes dead and belongs to the team last in possession (*Exception:* Rule 7-2-2-a Exceptions).

## After the Ball Is Snapped

ARTICLE 3. No offensive lineman may receive a hand-to-hand snap.

**PENALTY—Live-ball foul. Five yards from the previous spot [S19].**

## Out of Bounds

ARTICLE 4. a. *Backward Pass.* When a backward pass goes out of bounds between the goal lines, the ball belongs to the passing team at the out-of-bounds spot.

- b. *Fumble.* When a fumble goes out of bounds between the goal lines:
1. In advance of the spot of the fumble, the ball belongs to the fumbling team at the spot of the fumble (Rule 3-3-2-e-2).
  2. Behind the spot of the fumble, the ball belongs to the fumbling team at the out-of-bounds spot.
- c. *Behind or Beyond Goal Line.* When a fumble or backward pass goes out of bounds behind or beyond a goal line, it is a safety or touchback depending on impetus and responsibility (Rules 8-5-1, 8-6-1 and 8-7) (A.R. 7-2-4-I, A.R. 8-6-1-I and A.R. 8-7-2-I).

## At Rest

ARTICLE 5. a. *Backward Pass.* When a backward pass comes to rest inbounds and no player attempts to secure it, the ball becomes dead and belongs to the passing team at the dead-ball spot.

- b. *Fumble.* When a fumble comes to rest inbounds and no player attempts to secure it:
1. In advance of the spot of the fumble, the ball belongs to the fumbling team at the spot of the fumble.
  2. Behind the spot of the fumble, the ball belongs to the fumbling team at the dead ball spot.

## SECTION 3. Forward Pass

### Legal Forward Pass

ARTICLE 1. Team A may make one forward pass during each scrimmage down before team possession changes, provided the pass is thrown from a point in or behind the neutral zone.

### Illegal Forward Pass

ARTICLE 2. A forward pass is illegal if:

- a. It is thrown by a Team A player whose entire body is beyond the neutral zone when the ball is released.
- b. It is thrown by a Team B player.
- c. It is thrown after team possession has changed during the down.
- d. It is the second forward pass during the same down.
- e. It is thrown from in or behind the neutral zone after a ball carrier's entire body and the ball have been beyond the neutral zone.

**PENALTY [a-e]—Five yards from the spot of the foul; also loss of down if by Team A before team possession changes during a scrimmage down (A.R. 3-4-3-IV and A.R. 7-3-2-II) [S35 and S9].**

- f. The passer to conserve time throws the ball directly to the ground (1) after the ball has already touched the ground; or (2) not immediately after controlling the ball.
- g. The passer to conserve time throws the ball forward into an area where there is no eligible Team A receiver (A.R. 7-3-2-II-VII).
- h. The passer to conserve yardage throws the ball forward into an area where there is no eligible Team A receiver (A.R. 7-3-2-I).

**[Exception:** It is not a foul if the passer is or has been outside the tackle box and throws the ball so that it crosses or lands beyond the neutral zone or neutral zone extended (Rule 2-19-3) (A.R. 7-3-2-VIII-X). This applies only to the player who controls the snap or the resulting backward pass and does not relinquish possession to another player before throwing the forward pass.]

**PENALTY [f-h]—Loss of down at the spot of the foul [S36 and S9].**

### Eligibility To Touch Legal Forward Pass

ARTICLE 3. a. Eligibility rules apply during a down when a legal forward pass is thrown.

- b. All Team B players are eligible to touch or catch a pass.
- c. When the ball is snapped, the following Team A players are eligible:
  1. Each lineman who is on the end of their scrimmage line and who is wearing a number other than 50 through 79.
  2. Each back wearing a number other than 50 through 79.
- d. An eligible player loses their eligibility when the player goes out of bounds. (Rule 7-3-4) (A. R. 7-3-9-III)

### Eligibility Lost by Going Out of Bounds

ARTICLE 4. No eligible offensive receiver who goes out of bounds and returns in bounds during a down shall touch a legal forward pass while in the field of

play or end zones or while airborne until it has been touched by an opponent or official (A.R. 7-3-4-I, II and IV). [**Exception:** This does not apply to an originally eligible offensive player who immediately returns inbounds after going out of bounds due to contact by an opponent (A.R. 7-3-4-III)]. If the player touches the pass before returning in bounds, it is an incomplete pass (Rule 7-3-7) and not a foul for illegal touching.

**PENALTY—Loss of down at the previous spot [S16 and S9].**

### Eligibility Gained or Regained

ARTICLE 5. When a Team B player or an official touches a legal forward pass, all players become eligible (A.R. 7-3-5-I).

### Complete Pass

ARTICLE 6. Any forward pass is complete when caught by a player of the passing team who is inbounds, and the ball continues in play unless completed in the opponent's end zone or the pass has been caught simultaneously by opposing players. If a forward pass is caught simultaneously by opposing players inbounds, the ball becomes dead and belongs to the passing team (Rules 2-4-3 and 2-4-4) (A.R. 2-4-3-III and A.R. 7-3-6-I-VIII).

### Incomplete Pass

ARTICLE 7. a. Any forward pass is incomplete if the ball is out of bounds by rule (Rule 4-2-3) or if it touches the ground when not firmly controlled by a player. It also is incomplete when a player leaves their feet and receives the pass but first lands on or outside a boundary line, unless their progress has been stopped in the field of play or end zone (Rule 4-1-3-p) (A.R. 2-4-3-III and A.R. 7-3-7-I).

- b. When a legal forward pass is incomplete, the ball belongs to the passing team at the previous spot.
- c. When an illegal forward pass is incomplete, the ball belongs to the passing team at the spot of the pass (**Exception:** If Team B declines the penalty for an illegal pass thrown from the end zone, the ball shall next be put in play at the previous spot.) (A.R. 7-3-7-II-III).

### Illegal Contact and Pass Interference

ARTICLE 8. a. During a down in which a legal forward pass crosses the neutral zone, illegal contact by Team A and Team B players is prohibited from the time the ball is snapped until it is touched by any player or an official (A.R. 7-3-8-II).

- b. Offensive pass interference is contact by a Team A player beyond the neutral zone that interferes with a Team B player during a legal forward pass play in which the forward pass crosses the neutral zone. It is the responsibility of the offensive player to avoid the opponents. It is not offensive pass interference (A.R. 7-3-8-IV, V, X, XV and XVI):
  - 1. When, after the snap, a Team A ineligible player immediately charges and contacts an opponent at a point not more than one yard beyond the neutral zone and maintains the contact for no more than three yards beyond the neutral zone. (A.R. 7-3-10-II)

2. When two or more eligible players are making a simultaneous and bona fide attempt to reach, catch or bat the pass. Eligible players of either team have equal rights to the ball (A.R. 7-3-8-IX).
3. When the pass is in flight and two or more eligible players are in the area where they might receive or intercept the pass and an offensive player in that area impedes an opponent, and the pass is not catchable.

**PENALTY—15 yards from the previous spot [S33].**

- c. Defensive pass interference is contact beyond the neutral zone by a Team B player whose intent to impede an eligible opponent is obvious and could prevent the opponent the opportunity of receiving a catchable forward pass. When in question, a legal forward pass is catchable. Defensive pass interference occurs only after a legal forward pass is thrown (A. R. 7-3-8-VII, VIII, XI and XII).

It is not defensive pass interference (A.R. 7-3-8-III and 7-3-9-III):

1. When, after the snap, opposing players immediately charge and establish contact with opponents at a point that is within one yard beyond the neutral zone.
2. When two or more eligible players are making a simultaneous and bona fide attempt to reach, catch or bat the pass. Eligible players of either team have equal rights to the ball (A.R. 7-3-8-IX).
3. When a Team B player legally contacts an opponent before the pass is thrown (A.R. 7-3-8-III and X).
4. When there is contact by a Team B player that otherwise would be pass interference during a down in which a Team A potential kicker, from a scrimmage kick formation, simulates a scrimmage kick by throwing the ball high and deep.

**PENALTY—Team A's ball at the spot of the foul, first down, if the foul occurs fewer than 15 yards beyond the previous spot. If the foul occurs 15 or more yards beyond the previous spot, Team A's ball, first down, 15 yards from the previous spot [S33].**

When the ball is snapped on or inside the Team B 17-yard line and outside the Team B two-yard line, and the spot of the foul is on or inside the two-yard line, the penalty from the previous spot shall place the ball at the two-yard line, first down (A.R. 7-3-8-XIV).

No penalty enforced from outside the two-yard line may place the ball inside the two-yard line (*Exception:* On the Try when the snap is on or inside the three-yard line, Rule 10-2-5-b).

If the previous spot was on or inside the two-yard line, first down halfway between the previous spot and the goal line (Rule 10-2-6 Exception).

**Pass Interference: Summary**

- ARTICLE 9. a. Either Team A or Team B legally may interfere with opponents behind the neutral zone.
- b. Players of either team legally may interfere beyond the neutral zone after the pass has been touched (A.R. 7-3-9-I).

- c. Defensive players legally may contact opponents who have crossed the neutral zone if the opponents are not in a position to receive a catchable forward pass.
  - 1. Those infractions that occur during a down in which a forward pass crosses the neutral zone are pass interference infractions only if the receiver had the opportunity to receive a catchable forward pass.
  - 2. Those infractions that occur during a down in which a forward pass does not cross the neutral zone are Rule 9-3-4 infractions and the penalty is enforced from the previous spot.
- d. Pass interference rules apply only during a down in which a legal forward pass crosses the neutral zone (Rules 2-19-3 and 7-3-8-a, b and c).
- e. Contact by Team B with an eligible receiver involving a personal foul that interferes with the reception of a catchable pass may be ruled either as pass interference or as a personal foul with the 15-yard penalty enforced from the previous spot. Rule 7-3-8 is specific about contact during a pass. However, if the interference involves an act that ordinarily would result in disqualification or ejection, the fouling player is disqualified or ejected from the game.
- f. Physical contact is required to establish interference. (A.R. 7-3-8-I)
- g. Each player has territorial rights, and incidental contact is ruled under “attempt to reach...the pass” in Rule 7-3-8. If opponents who are beyond the line collide while moving toward the pass, a foul by one or both players occurs only if intent to impede the opponent is obvious. It is pass interference only if a catchable forward pass is involved.
- h. Pass interference rules do not apply after the pass has been touched anywhere inbounds by an inbounds player or has touched an official. If an opponent is fouled, the penalty is for the foul and not pass interference (A.R. 7-3-9-I).
- i. After the pass has been touched, any player may execute a legal block during the remaining flight of the pass.
- j. Tackling or grasping a receiver or any other intentional contact before the receiver touches the pass is evidence that the tackler is disregarding the ball and is therefore illegal.
- k. Tackling or running into a receiver when a forward pass obviously is underthrown or overthrown is disregarding the ball and is illegal. This is not pass interference but a violation of Rule 9-1-12-a, which carries a penalty of 15 yards from the previous spot plus a first down. Flagrant offenders shall be disqualified or ejected.

### **Ineligible Receiver Downfield**

ARTICLE 10. No originally ineligible receiver shall be or have been more than three yards beyond the neutral zone until a passer throws a legal forward pass that crosses the neutral zone. A player is in violation of this rule if any part of their body is beyond the three-yard limit. (*Exception:* If the passer is legally throwing the ball away and the ball lands near or beyond the sideline.) (A.R. 7-3-10-I and -III).

**PENALTY—Five yards from the previous spot [S37].**



**Illegal Touching**

ARTICLE 11. No originally ineligible player while inbounds may intentionally touch a legal forward pass until it has touched an opponent or an official (A.R. 5-2-3-I and A.R. 7-3-11-I-II).

**PENALTY—Five yards from the previous spot, loss of down [S16 and S9].**

**Team B Personal Foul and Unsportsmanlike Conduct During Legal Forward Pass Play**

ARTICLE 12. Penalties for personal fouls and unsportsmanlike conduct by Team B during a completed legal forward pass play are enforced at the end of the last run when it ends beyond the neutral zone. If the pass is incomplete or intercepted, or if there is a change of team possession during the down, the penalty is enforced at the previous spot. (Rule 9-1 Penalty) (A. R. 7-3-12-I and 9-1-2-III)

---

# RULE 8

## Scoring

---

### SECTION 1. Value of Scores

#### Scoring Plays

ARTICLE 1. The point value of scoring plays shall be:

Touchdown — 6 Points

Field Goal — 3 Points

Safety (points awarded to opponent) — 2 Points

Successful Try:

Touchdown — 2 Points

Field Goal or Safety — 1 Point

#### Forfeited Games

ARTICLE 2. The score of a forfeited game, or a suspended game that later results in a forfeiture, shall be: Offended Team—1, Opponent—0. However, if the offended team is ahead at the time of forfeit, the score stands (Rules 3-3-3-a and b, and Rules 9-2-3).

### SECTION 2. Touchdown

#### How Scored

ARTICLE 1. A touchdown shall be scored when:

- a. A ball carrier advancing from the field of play has possession of a live ball when it penetrates the plane of the opponent's goal line. This plane extends beyond the pylons only for a player who touches the ground in the end zone or a pylon. (A.R. 2-23-1-I and A.R. 8-2-1-I-IX).
- b. A player catches a forward pass in the opponent's end zone (A.R. 5-1-3-I and II).
- c. A fumble or backward pass is recovered, caught, intercepted or awarded in the opponent's end zone (**Exceptions:** Rules 7-2-2-a Exception 2, 7-2-5-b and 8-3-2-d-5). (A.R. 8-2-1-X)
- d. A free kick or scrimmage kick is legally caught or recovered in the opponent's end zone. (A.R. 6-3-9-III).
- e. The referee awards a touchdown under the provisions of Rule 9-2-3 Penalty.

### SECTION 3. Try Down

#### How Scored

ARTICLE 1. If the try results in what would be a touchdown, safety or field goal under rules governing play at other times, the point or points shall be scored according to the point values in Rule 8-1-1 (A.R. 8-3-1-I-II; A.R. 8-3-2-I-III and VI; and A.R. 10-2-5-X-XV).

### Opportunity to Score

ARTICLE 2. A try is an opportunity for either team to score one or two points while the game clock is stopped after a touchdown. It is a special interval in the game which, for purposes of penalty enforcement only, includes both a down and the “ready” period that precedes it.

- a. The ball shall be put in play by the team that scored a six-point touchdown. If a touchdown is scored during a down in which time in the fourth period expires, the try shall not be attempted unless the point(s) would affect the outcome of the game. (**Exception:** If the scoring team is ahead by one or two points, they have the option to forego the try.)
- b. The try, which is a scrimmage down, begins when the ball is ready for play.
- c. The snap will be midway between the hash marks on the opponent’s three-yard line or from any other point on or between the hash marks on or behind the opponent’s three-yard line if the position of the ball is selected by the team designated to put the ball in play before the play clock is at 25 seconds or before any subsequent ready-for-play signal. The ball may be relocated after a Team B foul or a charged timeout to either team, unless the timeout is preceded by a Team A foul or offsetting fouls (Rules 8-3-3-a and 8-3-3-c-1).
- d. The try ends when:
  1. Either team scores.
  2. The ball is dead by rule (A.R. 8-3-2-IV and VI).
  3. An accepted penalty results in a score.
  4. A Team A loss-of-down penalty is accepted (Rule 8-3-3-c-2).
  5. Before a change of team possession, a Team A player fumbles and the ball is caught or recovered by any Team A player other than the fumbler. There is no Team A score (A.R. 8-3-2-VIII).

### Fouls During a Try Before a Change of Team Possession

ARTICLE 3. a. Offsetting fouls: If both teams foul during the down and Team B fouls before the change of possession, the fouls offset and the down is repeated, even if additional fouls occur after the change of possession. Any repeat of the down after offsetting fouls must be from the previous spot (A.R. 8-3-3-II).

- b. *Fouls by Team B on a try:*
  1. When the try is successful Team A shall have the option of declining the score and repeating the try after enforcement, or declining the penalty(ies) and accepting the score. Team A may accept the score with penalties for personal fouls and unsportsmanlike conduct fouls enforced on the succeeding kickoff or from the succeeding spot in extra periods (A.R. 3-2-3-VI; A.R. 8-3-2-II; A.R. 8-3-3-I; and A.R. 10-2-5-IX-XI).
  2. A repeat of the down after a penalty against Team B may be from any point on or between the hash marks on or behind the yard line where the penalty leaves the ball. (A.R. 8-3-3-III)
- c. *Fouls by Team A on a try:*
  1. After a foul by Team A on a successful try, the ball shall be put in play at the spot where the penalty leaves it (A.R. 8-3-3-I).

2. If Team A commits a foul for which the penalty includes loss of down, the try is over, and the score is canceled, and no yardage penalty is assessed on the succeeding kickoff.
  3. If before a change of team possession Team A commits a foul that is not offset, and during the down there is neither another change of team possession nor a score, the penalty is declined by rule.
- d. Dead-ball enforcement:
1. Penalties for fouls occurring after the ball is ready for play and before the snap are enforced before the next snap.
  2. Penalties for live-ball fouls treated as dead-ball fouls occurring during the try down are enforced on the succeeding kickoff or from the succeeding spot in extra periods. If the try is replayed, these penalties are enforced on the replay (Rule 10-1-6) (A.R. 3-2-3-VII).
- e. Roughing or running into kicker or holder: Roughing or running into the kicker or holder is a live-ball foul.
- f. Kick-catch interference: The penalty for interference with a kick catch is declined by rule. Any score by Team A is canceled.

### **Fouls During a Try After a Change of Team Possession**

ARTICLE 4. a. Penalties against either team are declined by rule. (*Exception:* Penalties for flagrant personal fouls, unsportsmanlike conduct fouls, dead-ball personal fouls and live-ball fouls treated as dead-ball fouls are enforced on the succeeding kickoff or at the succeeding spot in extra periods. See Rule 8-3-5.) (A.R. 8-3-4-I and II)

- b. A score by a team committing a foul during the down is canceled. (*Exception:* Live-ball foul treated as a dead-ball foul.) (A.R. 8-3-2-VII)
- c. If both teams foul during the down and Team B had not fouled before the change of possession, the fouls cancel, the down is not repeated, and the try is over. (*Exception:* Penalties for flagrant personal fouls, unsportsmanlike conduct fouls, dead-ball personal fouls and live-ball fouls treated as dead-ball fouls are enforced on the succeeding kickoff or at the succeeding spot in extra periods. See Rule 8-3-5.)

### **Fouls After a Try**

ARTICLE 5. Penalties for fouls occurring after a try are enforced on the succeeding kickoff or from the succeeding spot in extra periods. However, if the try is repeated, these penalties are enforced before the repeat (Rule 10-1-6) (A.R. 10-2-5-XIII-XV and A.R. 3-2-3-VII).

### **Next Play**

ARTICLE 6. After a try, the ball shall be put in play by a kickoff or at the succeeding spot in extra periods. The team scoring the six-point touchdown shall kick off.

## **SECTION 4. Field Goal**

### **How Scored**

ARTICLE 1. a. A field goal shall be scored if a scrimmage kick, which may be a drop kick or place kick, passes over the crossbar between the uprights of

the receiving team's goal before it touches a player of the kicking team or the ground.

- b. If a legal field goal attempt passes over the crossbar between the uprights and is dead beyond the end line or is blown back but does not return over the crossbar and is dead anywhere, it shall score a field goal. The crossbar and uprights are treated as a line, not a plane, in determining forward progress of the ball.

### Next Play

ARTICLE 2. a. *Successful field goal.* After a field goal is scored, the ball shall be put in play by a kickoff or at the succeeding spot in extra periods. The team scoring the field goal shall kick off.

b. *Unsuccessful field-goal attempt.*

1. If the ball untouched by Team B after crossing the neutral zone is declared dead, it belongs to Team B. Except in an extra period Team B will snap the ball at the previous spot unless the previous spot was between its 20-yard line and its goal line. In that case Team B will next snap the ball at its 20-yard line.
  - (a) The 20-yard-line snap shall be from midway between the hash marks unless Team B selects a different location on or between the hash marks before the ready-for-play signal.
  - (b) After the ready-for-play signal, the ball may be relocated after a charged team timeout, unless preceded by a Team A foul or offsetting fouls.
2. If the ball does not cross the neutral zone, or if Team B touches the ball after it crosses the neutral zone, all rules pertaining to scrimmage kicks apply (A.R. 6-3-4-II, A.R. 8-4-2-I-VI and A.R. 10-2-3-V).
3. If the ball crosses the neutral zone, is untouched by Team B after crossing the neutral zone, and is declared dead behind the neutral zone, all rules pertaining to scrimmage kicks apply (A.R. 8-4-2-VII).

## SECTION 5. Safety

### How Scored

ARTICLE 1. It is a safety when:

- a. The ball becomes dead out of bounds behind a goal line, except from an incomplete forward pass, or becomes dead in the possession of a player on, above or behind their own goal line, or becomes dead by rule, and the defending team is responsible for the ball being there (A.R. 6-3-1-IV; A.R. 7-2-4-I; A.R. 8-5-1-I-II, IV and VI-X; A.R. 8-7-2-II; and A.R. 9-4-1-VIII).

When in question, it is a touchback, not a safety.

#### **Exception:**

It is not a safety if a player between their own team's five-yard line and goal line:

- (a) intercepts a pass or fumble; or recovers an opponent's fumble or backward pass; or catches or recovers a kick; and
- (b) the player's original momentum carries that player into their own end zone; and

- (c) the ball remains behind that team's goal line and is declared dead in that team's possession there. This includes a fumble that goes from the end zone into the field of play and out of bounds (Rule 7-2-4-b-1).

If conditions (a)-(c) are satisfied above, the ball belongs to this player's team at the spot where that player gained possession.

- b. An accepted penalty for a foul leaves the ball on or behind the offending team's goal line (**Exception:** Rules 3-1-3-g-3 and 8-3-4-a) (A.R. 8-5-1-III and A.R. 10-2-2-VI).

### **Kick After Safety**

ARTICLE 2. After a safety is scored, the ball belongs to the defending team at its own 20-yard line, and that team shall put the ball in play on or between the hash marks by a free kick that may be a punt, drop kick or place kick (**Exception:** Extra-period and try rules).

## **SECTION 6. Touchback**

### **When Declared**

ARTICLE 1. It is a touchback when:

- a. The ball becomes dead out of bounds behind a goal line, except from an incomplete forward pass, or becomes dead in the possession of a player on, above or behind their own goal line and the attacking team is responsible for the ball being there (Rules 7-2-4-c) (A.R. 7-2-4-I, A.R. 8-6-1-I-III).
- b. A kick becomes dead by rule behind the defending team's goal line and the attacking team is responsible for the ball being there (**Exception:** Rule 8-4-2-b) (A.R. 6-3-4-III).

### **Snap After a Touchback**

ARTICLE 2. After a touchback is declared, the ball belongs to the defending team at its own 20-yard line, unless the touchback results from a free kick, in which case the ball belongs to Team B at its 25-yard line. The ball shall be put in play on or between the hash marks by a snap (**Exception:** Extra-period rules). The snap shall be from midway between the hash marks, unless a different position on or between the hash marks is selected by the team designated to put the ball in play before the play clock is at 25 seconds or before any subsequent ready-for-play signal. After the ready-for-play signal, the ball may be relocated after a charged team timeout, unless preceded by a Team A foul or offsetting fouls.

## **SECTION 7. Responsibility and Impetus**

### **Responsibility**

ARTICLE 1. The team responsible for the ball being out of bounds behind a goal line or being dead in the possession of a player on, above or behind a goal line is the team whose player carries the ball or imparts an impetus to it that forces it on, above or across the goal line, or is responsible for a loose ball being on, above or behind the goal line.

**Initial Impetus**

ARTICLE 2. a. The impetus imparted by a player who kicks, passes, snaps or fumbles the ball shall be considered responsible for the ball's progress in any direction even though its course is deflected or reversed after striking the ground or after touching an official or a player of either team (A.R. 6-3-4-III; A.R. 8-5-1-II, VI and VIII; and A.R. 8-7-2-I-IV).

- b. Initial impetus is considered expended and the responsibility for the ball's progress is charged to a player:
  - 1. If that player kicks a ball not in player possession or bats a loose ball after it strikes the ground
  - 2. If the ball comes to rest and that player gives it new impetus by any contact with it, other than through forced touching (Rule 2-11-4-c).
- c. A loose ball retains its original status when there is new impetus.

---

# RULE 9

## Conduct of Players and Others Subject to the Rules

---

### SECTION 1. Personal Fouls

All fouls in this section (unless noted) and any other acts of unnecessary roughness are personal fouls. For flagrant personal fouls mandating conference review, see Rule 9-6. Except as otherwise noted, the penalties for all personal fouls are as follows:

**PENALTY—Personal foul. 15 yards. For dead-ball fouls, 15 yards from the succeeding spot. Automatic first down for fouls by Team B if not in conflict with other rules. Penalties for Team A live-ball personal fouls behind the neutral zone are enforced from the previous spot. Safety if the live-ball foul occurs behind Team A's goal line [S7, S24, S25, S26, S28, S34, S38, S39, S40, S41, S45 or S46]. Flagrant offenders shall be ejected or disqualified [S47].**

For Team A fouls during free or scrimmage kick plays: Enforcement may be at the previous spot or, if the scrimmage kick crosses the neutral zone, the spot where the subsequent dead ball belongs to Team B (field-goal plays exempted) (Rules 6-1-8 and 6-3-13).

For Team B personal fouls during a legal forward pass play (Rules 7-3-12 and 10-2-2-e): Enforcement is at the end of the last run when it ends beyond the neutral zone and there is no change of team possession during the down. If the pass is incomplete or intercepted, or if there is a change of team possession during the down, the penalty is enforced at the previous spot.

### Flagrant Fouls

ARTICLE 1. Before the game, during the game and between periods, all flagrant fouls (Rule 2-10-3) require ejection or disqualification. Team B flagrant personal fouls require first downs if not in conflict with other rules.

### Striking Fouls and Tripping

ARTICLE 2. a. No person subject to the rules shall strike an opponent with the knee; strike an opponent's helmet (including the face mask), neck, face or any



- other part of the body with an extended forearm, elbow, locked , palm, fist, or the heel, back or side of the open hand; or gouge an opponent (A.R. 9-1-2-I).
- b. No person subject to the rules shall strike an opponent with their foot or any part of their leg that is below the knee.
  - c. There shall be no tripping. Tripping is intentionally using the lower leg or foot to obstruct an opponent below the knee. (Rule 2-28)

### **Targeting and Making Forcible Contact With the Crown of the Helmet**

ARTICLE 3. No player shall target and make forcible contact against an opponent with the crown of their helmet. The crown of the helmet is the top segment of the helmet; namely, the circular area defined by a 6-inch radius from the apex (top) of the helmet. This foul requires that there be at least one indicator of targeting (See *Note 1* below). When in question, it is a foul. (Rule 9-6) (A.R. 9-1-3-I)

### **Targeting and Making Forcible Contact to Head or Neck Area of a Defenseless Player**

ARTICLE 4. No player shall target and make forcible contact to the head or neck area of a defenseless opponent (See *Note 2* below) with the helmet, forearm, hand, fist, elbow or shoulder. This foul requires that there be at least one indicator of targeting (See *Note 1* below). When in question, it is a foul (Rules 2-27-14 and 9-6). (A.R. 9-1-4-I-VI)

**Note 1:** “Targeting” means that a player takes aim at an opponent for purposes of attacking with forcible contact that goes beyond making a legal tackle or a legal block or playing the ball. Some *indicators of targeting* include but are not limited to:

- Launch. A player leaving their feet to attack an opponent by an upward and forward thrust of the body to make forcible contact in the head or neck area.
- A crouch followed by an upward and forward thrust to attack with forcible contact at the head or neck area, even though one or both feet are still on the ground.
- Leading with helmet, shoulder, forearm, fist, hand or elbow to attack with forcible contact at the head or neck area.
- Lowering the head before attacking by initiating forcible contact with the crown of the helmet.

**Note 2:** Defenseless player (Rule 2-27-14). When in question, a player is defenseless. *Examples of defenseless players include but are not limited to:*

- A player in the act of or just after throwing a pass. This includes an offensive player in a passing posture with focus downfield.
- A receiver attempting to catch a forward pass or in position to receive a backward pass, or one who has completed a catch and has not had time to protect themselves or has not clearly become a ball carrier.
- A kicker in the act of or just after kicking a ball, or during the kick or the return.
- A kick returner attempting to catch or recover a kick, or one who has completed a catch or recovery and has not had time to protect themselves or has not clearly become a ball carrier.

- A player on the ground.
- A player obviously out of the play.
- A player who receives a blind-side block.
- A ball carrier already in the grasp of an opponent and whose forward progress has been stopped.
- A quarterback any time after a change of possession
- A ball carrier who has obviously given themselves up and is sliding feet-first.

**PENALTY**—[ARTICLE 3 and ARTICLE 4]—15 yards. For dead-ball fouls, 15 yards from the succeeding spot. Automatic first down for fouls by Team B if not in conflict with other rules. For fouls in the first half: Disqualification for the remainder of the game. (Rule 2-27-12) For fouls in the second half: Disqualification for the remainder of the game and the first half of the next game. If the foul occurs in the second half of the last game of the season, players with remaining eligibility shall serve the suspension during the postseason or the first game of the following season.

If a player receives a third Targeting foul within the same season, disqualification for the remainder of the game and that player will receive an automatic one-game suspension in their team's next scheduled game. Targeting fouls subsequent to the player's third Targeting foul within the same season, disqualification for the remainder of that game and the player will receive an automatic one-game suspension in their team's next scheduled game. If the foul occurs in the last game of the season, players with remaining eligibility shall serve the suspension during the postseason or the first game of the following season.

The disqualification must be reviewed by Instant Replay (Rule 12-3-5). [S38, S24 and S47]

When the Instant Replay Official overturns the disqualification:

If the targeting foul is not in conjunction with another personal foul by the same player, the 15-yard penalty for targeting is not enforced. If the player commits another personal foul in conjunction with the targeting foul, the 15-yard penalty for that personal foul is enforced according to rule. (A. R. 9-1-4-VII-VIII)

**For games in which Instant Replay is used:**

If a player is disqualified in the second half, the conference has the option to consult the national coordinator of football officials who would then facilitate a video review. Based on the review, if and only if the national coordinator concludes that it is clearly obvious the player should not have been disqualified, the suspension will be vacated. If the national coordinator supports the disqualification, the suspension for the next game will remain.

**For games in which Instant Replay is not used:**

If a player is disqualified in the first half, at the option of the conference or by pre-game mutual agreement of the teams in inter-conference games, during the intermission between halves the Referee will be provided a video of the play in question for their review in the officials' private secure location. The Referee will review the video to determine whether the disqualification is overturned. The decision of the Referee is final. (A. R. 9-1-4-IX)

*Note:* The video source and the location of the review will be determined prior to the game through mutual agreement of the teams and the Referee.

If a player is disqualified in the second half, the conference has the option to consult the national coordinator of football officials who would then facilitate a video review. Based on the review, if and only if the national coordinator concludes that the player should not have been disqualified, the suspension will be vacated. If the national coordinator supports the disqualification, the suspension for the next game will remain.

**Clipping**

ARTICLE 5. There shall be no clipping (Rule 2-5).

***Exceptions:***

1. Offensive players who are on the line of scrimmage at the snap within the blocking zone (Rule 2-3-6) legally may clip in the blocking zone, subject to the following restrictions:
  - (a) A player in the blocking zone may not block an opponent with the force of the initial contact from behind and at or below the knee.
  - (b) A player on the line of scrimmage within the blocking zone may not leave the zone and return and legally clip.
  - (c) No player may violate Rule 9-1-6 (Blocking Below the Waist).

*Note:* The blocking zone disintegrates when the ball leaves the zone (Rule 2-3-6).
2. When a player turns their back to a potential blocker who has committed themselves in intent and direction or movement.
3. When a player attempts to reach a runner or attempts to legally recover or catch a fumble, a backward pass, a kick or a touched forward pass, that player may push an opponent below the waist at or to the buttocks (Rule 9-3-5, Exception 3).
4. When an eligible player behind the neutral zone pushes an opponent below the waist at or to the buttocks to get to a forward pass (Rule 9-3-5, Exception 5).
5. Clipping is allowed against the runner.

**Blocking Below the Waist**

ARTICLE 6. a. *Team A prior to a change of team possession:*

1. Linemen with initial position completely inside the tackle box may legally block below the waist inside the tackle box on their initial line charge. A block initiated 1-yard beyond the neutral zone is considered

within the tackle box. After the initial line charge, these linemen may block below the waist within the tackle box until the ball leaves the tackle box only if the force of the initial contact is directed from the front.

2. Stationary Backs lined up within the tackle box may block below the waist within the tackle box until the ball leaves the tackle box only if the force of the initial contact is directed from the front.

“Directed from the front” is defined as within the clock face region between “10 o’clock and 2 o’clock” forward of the area of concentration of the player being blocked.

3. All other Team A players are not allowed to block below the waist.

b. *Team B prior to a change of team possession:*

1. Players aligned in a stationary position within 1-yard of the line of scrimmage within the tackle box may legally block below the waist in the tackle box on their initial line charge.

2. All other Team B players are not allowed to block below the waist except against a ball carrier.

c. *Kicks.* During a down in which there is a free kick or scrimmage kick, blocking below the waist by any player is illegal except against a ball carrier.

d. *After change of team possession.* After any change of team possession, blocking below the waist by any player is illegal except against a ball carrier.

e. *Clipping.* No player may violate Rule 9-1-5 (Clipping).

### Late Hit, Action Out of Bounds

ARTICLE 7. a. There shall be no piling on, falling on or throwing the body on an opponent after the ball becomes dead (A.R. 9-1-7-I).

b. No opponent shall tackle or block the runner when the runner is clearly out of bounds or throw the runner to the ground after the ball becomes dead.

c. It is illegal for any player to be clearly out of bounds when initiating a block against an opponent who is out of bounds. The spot of the foul is where the blocker crosses the sideline in going out of bounds.

### Helmet and Face Mask Fouls

ARTICLE 8. a. No player shall continuously contact an opponent’s face, helmet (including the face mask) or neck with hand(s) or arm(s) (*Exception:* By or against the runner). [S26]

b. No player shall grasp and then twist, turn or pull the face mask, chin strap or any helmet opening of an opponent. It is not a foul if the face mask, chin strap or helmet opening is not grasped and then twisted, turned or pulled. When in question, it is a foul.

### Roughing the Passer

ARTICLE 9. a. No defensive player shall unnecessarily rough a passer, when it is obvious the ball has been thrown. The following actions are illegal, but not limited to:

1. Targeting fouls as noted in Rules 9-1-3 and 9-1-4.
2. Forcible contact to the head or neck area that does not meet the requirements of Rule 9-1-4 (also reference Rule 9-1-2).

3. Forcible contact that is avoidable after it is obvious the ball has left the passer's hand. (**Exception:** A defensive player who is blocked by a Team A player[s] with a force so that they have no opportunity to avoid contact with the passer. However, this does not relieve the defensive player of responsibility for personal fouls as described in elsewhere in this section.)
  4. Forcibly driving the passer to the ground and landing on the passer with action that punishes the player.
  5. Any action that is a personal foul as described elsewhere in this section.
- b. When an offensive player is in a passing posture with one or both feet on the ground, no defensive player rushing unabated shall hit the player forcibly at the knee area or below. The defensive player also may not initiate a roll or lunge and forcibly hit this opponent in the knee area or below. [**Exceptions:** (1) It is not a foul if the offensive player is a runner not in a passing posture, either inside or outside the tackle box. (2) It is not a foul if the defender grabs or wraps this opponent in an attempt to make a conventional tackle without making forcible contact with the head or shoulder. (3) It is not a foul if the defender is not rushing unabated or is blocked or fouled into this opponent.]

For paragraphs a and b, the penalty is added to the end of the last run when it ends beyond the neutral zone and there is no change of team possession during the down. (A.R. 9-1-9-II-III)

### Chop Blocking

ARTICLE 10. There shall be no chop blocking (Rule 2-3-3) (A.R. 9-1-10-I-V).

### Leverage and Leaping

ARTICLE 11. a. No defensive player, in an attempt to gain an advantage, may step, jump or stand on an opponent.

- b. It is a foul if a defensive player moves forward and tries to block a kick or apparent kick on a field goal or try by leaving their feet and leaping into the plane directly above the frame of the body of an opponent.  
It is not a foul if the player was aligned in a stationary position within one yard of the line of scrimmage when the ball was snapped.
- c. It is a foul if a defensive player who is inside the tackle box tries to block a punt or an apparent punt by leaving their feet and leaping into the plane directly above the frame of the body of an opponent.
  1. It is not a foul if the player tries to block the punt by jumping straight up without attempting to leap over the opponent.
  2. It is not a foul if a player leaps through or over the gap between players.
- d. No defensive player, in an attempt to block, bat or catch a kick or apparent kick, may:
  1. Step, jump or stand on a teammate.
  2. Place a hand(s) on a teammate to get leverage for additional height.
  3. Be picked up by a teammate, or be elevated, propelled or pushed.

**PENALTY [a-d]—15 yards, previous spot and automatic first down. [S38]**

- e. No player may position themselves with their feet on the back or shoulders of a teammate before the snap.

**PENALTY—Dead-ball foul. 15 yards from the succeeding spot. Automatic first down for fouls by Team B if not in conflict with other rules [S27].**

### **Contact Against an Opponent Out of the Play**

ARTICLE 12. a. No player shall tackle or run into a receiver when a forward pass to that receiver is obviously not catchable. This is a personal foul and not pass interference.

b. No player shall run into or throw themselves against an opponent obviously out of the play either before or after the ball is dead.

### **Hurdling**

ARTICLE 13. There shall be no hurdling (*Exception:* The ball carrier may hurdle an opponent).

### **Contact Against the Snapper**

ARTICLE 14. When a team is in scrimmage kick formation, a defensive player may not initiate contact with the snapper until one second has elapsed after the snap (A.R. 9-1-14-I-III).

### **Horse-Collar Tackle**

ARTICLE 15. All players are prohibited from grabbing the inside back collar of the shoulder pads or jersey, the nameplate area, or the inside collar of the side of the shoulder pads or jersey, and abruptly pulling the ball carrier down. This does not apply to a ball carrier, including a potential passer, who is inside the tackle box (Rule 2-34). Note that the tackle box disintegrates when the ball leaves it.

### **Roughing or Running Into Kicker or Holder**

ARTICLE 16. a. When it is obvious that a scrimmage kick will be made, no opponent shall run into or rough the kicker or the holder of a place kick (A.R. 9-1-16-I, III and VI).

1. Roughing is a live-ball personal foul that endangers the kicker or holder.
2. Running into the kicker or holder is a live-ball foul that occurs when the kicker or holder is displaced from their kicking or holding position but is not roughed (A.R. 9-1-16-II).
3. Incidental contact with a kicker or holder is not a foul.
4. The kicker's protection under this rule ends (a) when the kicker has had a reasonable time to regain their balance (A.R. 9-1-16-IV); or (b) when the kicker carries or possesses the ball outside the tackle box (Rule 2-34) before kicking.
5. When a defensive player's contact against the kicker or holder is caused by an opponent's block (legal or illegal), there is no foul for running into or roughing.
6. A player who makes contact with the kicker or holder after touching the kick is not charged with running into or roughing the kicker.
7. When a player other than one who blocks a scrimmage kick runs into or roughs the kicker or holder, it is a foul.
8. When in question whether the foul is *running into* or *roughing*, the foul is *roughing*.

**PENALTY—Roughing or any other personal foul against the kicker who is in the act or just after kicking the ball; or roughing the holder: 15 yards from the previous spot, plus automatic first down if not in conflict with other rules [S38 and S30]. Running into the kicker or holder: 5 yards from the previous spot [S30].**

- b. A kicker or holder simulating being roughed or run into by a defensive player commits an unsportsmanlike act (A.R. 9-1-16-V).

**PENALTY—15 yards from the previous spot or, if the scrimmage kick crosses the neutral zone, can be enforced where the subsequent dead ball belongs to Team B [S27].**

- c. The kicker of a free kick may not be blocked until they have advanced five yards beyond their restraining line, or until the ball has touched a player, an official or the ground.

**PENALTY—15 yards from the previous spot [S40].**

### **Continued Participation Without Helmet**

ARTICLE 17. A player whose helmet comes completely off during a down may not continue to participate beyond the immediate action in which they are engaged, whether or not the player puts the helmet back on during the down. (A.R. 9-1-17-1)

### **Blind-Side Block**

ARTICLE 18. No player shall deliver a blind-side block by attacking an opponent with forcible contact. (*Exceptions:* (1) the runner; (2) a receiver in the act of attempting to make a catch.) (*Note:* *In addition, if this action meets all the elements of targeting, it is a blind-slide block with targeting (Rule 9-1-3 and 9-1-4).*) (A.R. 9-1-18-1)

## **SECTION 2. Unsportsmanlike Conduct Fouls**

### **Unsportsmanlike Acts**

ARTICLE 1. There shall be no unsportsmanlike conduct or any act that interferes with orderly game administration on the part of players, substitutes, coaches, authorized attendants or any other persons subject to the rules, before the game, during the game or between periods. Infractions for these acts by players are administered as either live-ball or dead-ball fouls depending on when they occur. (A.R. 9-2-1-I-X)

- a. Specifically prohibited acts and conduct include:
  - 1. No player, substitute, coach or other person subject to the rules shall use abusive, threatening or obscene language or gestures, or engage in such acts that provoke ill will or are demeaning to an opponent, to game officials or to the image of the game, including but not limited to:
    - (a) Pointing the finger(s), hand(s), arm(s) or ball at an opponent, or imitating the slashing of the throat.
    - (b) Taunting, baiting or ridiculing an opponent verbally.
    - (c) Inciting an opponent or spectators in any other way, such as simulating the firing of a weapon or placing a hand by the ear to request recognition.

- (d) Any delayed, excessive, prolonged or choreographed act by which a player (or players) attempts to focus attention upon themselves (or themselves).
- (e) An unopposed ball carrier obviously altering stride when approaching the opponent's goal line or diving into the end zone.
- (f) A player removing their helmet after the ball is dead and before they are in the team area (**Exceptions:** Team, media or injury timeouts; equipment adjustment; through play; between periods; and during a measurement for a first down).
- (g) Punching one's own chest or crossing one's arms in front of the chest while standing over a prone player.
- (h) Going into the stands to interact with spectators, or bowing at the waist after a good play.
- (i) Intentionally removing the helmet while the ball is alive.
- (j) Dead-ball contact fouls such as pushing, shoving, striking, etc. that occur clearly after the ball is dead and that are not part of the game action. (A.R. 9-2-1-X)
- (k) After the ball is dead, using forcible contact to push or pull an opponent off the pile. (A.R. 9-2-1-XI)

**PENALTY—Unsportsmanlike conduct. Live-ball fouls by players: 15 yards [S27]. Live-ball fouls by non-players and all dead-ball fouls: 15 yards from succeeding spot [S7 and S27]. Automatic first down for live-ball and dead-ball fouls by Team B if not in conflict with other rules. Flagrant offenders, if players or substitutes, shall be ejected [S47].**

**For Team A fouls during free or scrimmage kick plays: Enforcement may be at the previous spot or, if the scrimmage kick crosses the neutral zone, the spot where the subsequent dead ball belongs to Team B (field-goal plays exempted) (Rules 6-1-8 and 6-3-13).**

**For Team B unsportsmanlike conduct fouls during a legal forward pass play (Rules 7-3-12 and 10-2-2-e): Enforcement is at the end of the last run when it ends beyond the neutral zone and there is no change of team possession during the down. If the pass is incomplete or intercepted, or if there is a change of team possession during the down, the penalty is enforced at the previous spot.**

2. After a score or any other play, the player in possession immediately must return the ball to an official or leave it near the dead-ball spot. This prohibits:
  - (a) Kicking, throwing, spinning or carrying (including off of the field) the ball any distance that requires an official to retrieve it.
  - (b) Spiking the ball to the ground [**Exception:** A forward pass to conserve time (Rule 7-3-2-f)].
  - (c) Throwing the ball high into the air.
  - (d) Any other unsportsmanlike act or actions that delay the game.

**PENALTY—Unsportsmanlike conduct. Dead-ball foul. 15 yards from the succeeding spot [S7 and S27]. Automatic first down for**



**fouls by Team B if not in conflict with other rules. Flagrant offenders, if players or substitutes, shall be ejected [S47].**

- b. Other prohibited acts include:
1. During the game, coaches, squad members, and authorized attendants in the team area may not be on the field of play or outside the 20-yard lines to protest an officiating decision or to communicate with players or officials without permission from the referee. (**Exceptions:** Rules 1-2-4-f, 3-3-4-d, 3-3-8-c, and 3-5-1).
  2. No ejected person shall be in view of the field of play (Rule 9-2-6).
  3. No person or mascot subject to the rules, except players, officials and eligible substitutes, shall be on the field of play or end zones during any period without permission from the referee. If a player is injured, attendants may come inbounds to attend him, but they must obtain recognition from an official.
  4. No substitute(s) may enter the field of play or end zones for purposes other than replacing a player(s) or to fill a player vacancy(ies). This includes demonstrations after any play (A.R. 9-2-1-I).
  5. Persons subject to the rules, including bands and audio/video/lighting systems operators, shall not create any noise or distraction that prohibits a team from hearing its signals or obstructs play (Rule 1-1-6).

**PENALTY [1-4]—Unsportsmanlike conduct. Dead-ball foul. 15 yards from the succeeding spot [S7 and S27]. Automatic first down for fouls by Team B if not in conflict with other rules. Flagrant offenders, if players or substitutes, shall be ejected [S47].**

**PENALTY [5]—Unsportsmanlike conduct. The referee may take any action they consider equitable, which includes directing that the down be repeated, including assessing a 15-yard penalty, awarding a score, or suspending or forfeiting the game [S27].**

### **Unfair Tactics**

ARTICLE 2. a. No player shall conceal the ball in or beneath their clothing or equipment or substitute any other article for the ball.

- b. No simulated replacements or substitutions may be used to confuse opponents. No tactic associated with substitutes or the substitution process may be used to confuse opponents (Rule 3-5-2-e) (A.R. 9-2-2-I-VI).
- c. No equipment may be used to confuse opponents (Rule 1-4-2-d).
- d. Two players playing the same position may not wear the same number during the game.

**PENALTY [a-d]—Unsportsmanlike conduct. Live-ball foul. 15 yards from the previous spot [S27]. Automatic first down for fouls by Team B if not in conflict with other rules. Flagrant offenders shall be ejected [S47].**

- e. No more than two Squad Members may be assigned or wear the same jersey number.

**PENALTY—Unsportsmanlike Conduct charged against the Head Coach and the players must immediately correct the numbering and report the change. Administer as a dead ball foul - 15 yards [S27].**

f. No player may play with cleats more than 1/2-inch in length (Rules 1-4-7-d).

**PENALTY—Ejection for the remainder of the game and the team's next game [S27 and S47]. Administer as a dead-ball foul; 15-yard penalty enforced at the succeeding spot. Automatic first down for fouls by Team B if not in conflict with other rules. Team timeout. VIOLATION—Rules 3-3-6 and 3-4-2-b [S23, S3 or S21]. If the ejection occurs during the last game of a season, players with eligibility remaining will serve the next-game ejection during the first game of the next season for which they are eligible.**

g. The referee will notify (in writing) their assigning agent of all ejections for illegal cleats. The assigning agency becomes responsible for implementation of the penalty.

### **Unfair Acts**

ARTICLE 3. The following are unfair acts:

- a. A team refuses to play within two minutes after ordered to do so by the referee.
- b. A team repeatedly commits fouls for which penalties can be enforced only by halving the distance to its goal line.
- c. An obviously unfair act not specifically covered by the rules occurs during the game. This includes substitutes, coaches or any other persons subject to the rules, other than a player or official, interfering in any way with the ball or a player while the ball is in play (A.R. 4-2-1-II, 9-2-3-I and 9-2-3-IV).

**PENALTY— Unsportsmanlike conduct. The referee may take any action they consider equitable, which includes directing that the down be repeated, including assessing a 15-yard penalty, awarding a score, or suspending or forfeiting the game [S27].**

### **Contacting an Official**

ARTICLE 4. Persons subject to the rules (Rule 1-1-6) shall not intentionally contact a game official forcibly during the game.

**PENALTY— Unsportsmanlike conduct. Administer as a dead-ball foul. 15 yards from the succeeding spot and automatic ejection. Automatic first down for fouls by Team B if not in conflict with other rules. [S7, S27 and S47].**

### **Game Administration and Sideline Interference**

ARTICLE 5. While the ball is alive and during the continuing action after the ball has been declared dead:

- a. Coaches, substitutes and authorized attendants in the team area must be behind the coaching line.

**PENALTY—Administer as a dead-ball foul. First infraction: Warning for sideline interference. No yardage penalty. [S15]**

**Second and third infractions: Delay of game for sideline interference, five yards from the succeeding spot. [S21 and S29]**

**Fourth and subsequent infractions: Team unsportsmanlike conduct for sideline interference, 15 yards from the succeeding**

**spot. Automatic first down for fouls by Team B if not in conflict with other rules. [S27 and S29]**

- b. Physical interference with an official is a foul charged to the team for unsportsmanlike conduct. (A.R. 9-2-5-1)

**PENALTY—Team unsportsmanlike conduct. Administer as a dead-ball foul. 15 yards from the succeeding spot. Automatic first down for fouls by Team B if not in conflict with other rules.[S27]**

### **Ejected Players and Coaches**

ARTICLE 6. a. Any coach, player or identified squad member in uniform who commits two unsportsmanlike conduct fouls in the same game shall be ejected.

- b. A player ejected from the game (Rule 2-27-12) must leave the playing enclosure under team supervision within a reasonable amount of time after their ejection. The player must remain out of view of the field of play under team supervision for the remainder of the game.
- c. A player serving a first-half suspension due to their ejection in the team's previous game may participate in pre-game warm-up activities. During the first half that player must remain out of view of the field of play under team supervision.
- d. A coach ejected from the game must leave the playing enclosure within a reasonable amount of time after the ejection and must remain out of view of the field of play for the remainder of the game.
- e. A head coach ejected from the game may designate a new head coach.

### **Use of Tobacco**

ARTICLE 7. Players, squad members and game personnel (e.g., coaches, athletics trainers, managers and game officials) are prohibited from using tobacco products from the time the officials assume jurisdiction until the referee declares the game over.

**PENALTY—Ejection. Dead-ball foul. 15 yards at the succeeding spot [S27 and S47].**

## **SECTION 3. Blocking, Use of Hands or Arms**

### **Who May Block**

ARTICLE 1. Players of either team may block opponents, provided it is not pass interference, interference with the opportunity to catch a kick or a personal foul (**Exception:** Rules 6-1-12 and 6-5-4).

### **Interfering for or Helping the Ball Carrier or Passer**

ARTICLE 2. a. The ball carrier or passer may use their hand or arm to ward off or push opponents.

- b. The ball carrier shall not grasp a teammate; and no other teammate shall grasp, pull, or lift the ball carrier to assist in forward progress. (A.R. 9-3-2-1)
- c. Teammates of the ball carrier or passer may interfere with opponents by blocking but shall not use interlocked interference by grasping or encircling one another in any manner while contacting an opponent.

**PENALTY—Five yards [S44].**

### **Holding and Use of Hands or Arms: Offense**

ARTICLE 3. a. *Use of Hands.* A teammate of a ball carrier or a passer legally may block with their shoulders, their hands, the outer surface of their arms or any other part of their body under the following provisions.

1. The hand(s) shall be:
  - (a) In advance of the elbow.
  - (b) Inside the frame of the opponent's body (**Exception:** When the opponent turns their back to the blocker) (A.R. 9-3-3-VI and VII).
  - (c) At or below the shoulder(s) of the blocker and the opponent (**Exception:** When the opponent squats, ducks or submarines).
  - (d) Apart and never in a locked position.
2. The hand(s) shall be open with the palm(s) facing the frame of the opponent or closed or cupped with the palms not facing the opponent (A.R. 9-3-3-I-IV and VI-VIII).
- b. *Holding.* The hand(s) and arm(s) shall not be used to grasp, pull, hook, clamp or encircle in any way that illegally impedes or illegally obstructs an opponent.

**PENALTY—10 yards Penalties for Team A fouls behind the neutral zone are enforced from the previous spot. Safety if the foul occurs behind Team A's goal line [S42].**

- c. *Kicking Team.* A player on the kicking team may:
  1. During a scrimmage kick play, use their hand(s) and/or arm(s) to ward off an opponent attempting to block them when they are beyond the neutral zone.
  2. During a free kick play, use their hand(s) and/or arm(s) to ward off an opponent who is attempting to block them.
  3. During a scrimmage kick play or a free kick play, when they are eligible to touch the ball, legally use their hand(s) and/or arm(s) to push an opponent in an attempt to reach a loose ball.
- d. *Passing Team.* An eligible player of the passing team legally may use their hand(s) and/or arm(s) to ward off or push an opponent in an attempt to reach a loose ball after a legal forward pass has been touched by any player or official (Rules 7-3-5, 7-3-8, 7-3-9 and 7-3-11).

### **Holding and Use of Hands or Arms: Defense**

ARTICLE 4. a. Defensive players may use hands and arms to push, pull, ward off or lift offensive players:

1. When attempting to reach the runner.
2. Who are obviously attempting to block them.
- b. A defensive player legally may use their hands or arms to ward off or block an opponent in an attempt to reach a loose ball (Rule 9-1-5, Exceptions 3 and 4 and Rule 9-3-5, Exceptions 3 and 5):
  1. During a backward pass, fumble or kick that they are eligible to touch.
  2. During any forward pass that crossed the neutral zone and has been touched by any player or official.
- c. When making no attempt to get at the ball or the runner, defensive players must comply with Article 3, paragraphs *a* and *b* above.

- d. Defensive players may not use hands and arms to tackle, hold or otherwise illegally obstruct an opponent other than a runner.
- e. Defensive players may ward off or legally block an eligible pass receiver until that player occupies the same yard line as the defender or until the opponent could not possibly block him. Continuous contact is illegal (A.R. 9-3-4-I).

**PENALTY [c-e]—10 yards plus automatic first down if the first down is not in conflict with other rules [S42].**

### **Blocking in the Back**

ARTICLE 5. A block in the back (other than against the ball carrier) is illegal (A.R. 9-3-3-I, VII and -IX; and A.R. 10-2-2-XII).

#### ***Exceptions:***

1. Offensive players who are on the line of scrimmage at the snap within the blocking zone (Rule 2-3-6) may legally block in the back in the blocking zone, subject to the following restrictions:
  - (a) A player on the line of scrimmage within this blocking zone may not leave the zone, return and block in the back.
  - (b) The blocking zone disintegrates when the ball leaves the zone (Rule 2-3-6).
2. When a player turns their back to a potential blocker who has committed themselves in intent and direction or movement.
3. When a player attempts to reach a runner or legally attempts to recover or catch a fumble, a backward pass, a kick or a touched forward pass, they may push an opponent in the back above the waist (Rule 9-1-5 Exception 3).
4. When the opponent turns their back to the blocker under Rule 9-3-3-a-1-(b).
5. When an eligible player behind the neutral zone pushes an opponent in the back above the waist to get to a forward pass (Rule 9-1-5 Exception 4).

**PENALTY—10 yards. Penalties for Team A fouls behind the neutral zone are enforced from the previous spot. Safety if the foul occurs behind Team A's goal line. [S43].**

## **SECTION 4. Batting and Kicking**

### **Batting a Loose Ball**

- ARTICLE 1. a. While a pass is in flight, only a player who is eligible to touch the ball may bat it in any direction (***Exception:*** Rule 9-4-2).
- b. Any player may block a scrimmage kick in the field of play or the end zone.
  - c. No player shall bat other loose balls forward in the field of play or in any direction if the ball is in the end zone (Rule 2-2-3-a) (***Exception:*** Rule 6-3-11) (A.R. 6-3-11-I, A.R. 9-4-1-I-X and A.R. 10-2-2-II).

**PENALTY—10 yards and loss of down for fouls by Team A if the loss of down is not in conflict with other rules [S31 and S9] [*Exception:* No loss of down if the foul occurs when a legal scrimmage kick is beyond the neutral zone].**

### **Batting a Backward Pass in Flight**

ARTICLE 2. A backward pass in flight shall not be batted forward by the passing team.

**PENALTY—10 yards [S31].**

### **Batting Ball in Possession**

ARTICLE 3. A ball in player possession may not be batted forward by a player of that team.

**PENALTY—10 yards [S31].**

### **Illegally Kicking Ball**

ARTICLE 4. A player shall not kick a loose ball, a forward pass or a ball being held for a place kick by an opponent. These illegal acts do not change the status of the loose ball or forward pass; but if the player holding the ball for a place kick loses possession during a scrimmage down, it is a fumble and a loose ball; if during a free kick, the ball remains dead (A.R. 8-7-2-IV and A. R. 9-4-1-XI).

**PENALTY—10 yards, plus loss of down for fouls by Team A if the loss of down is not in conflict with other rules [S31 and S9] (Exception: No loss of down if the foul occurs when a legal scrimmage kick is beyond the neutral zone).**

## **SECTION 5. Fighting**

ARTICLE 1. a. Before the game, squad members in uniform or coaches shall not participate in a fight (Rule 2-32-1).

During the first half, players shall not participate in a fight.

**PENALTY—15 yards. For dead-ball fouls, 15 yards from the succeeding spot. Automatic first down for Team B fouls if not in conflict with other rules. Ejection for the remainder of the game [S7, S27 or S38, and S47].**

b. During the half-time intermission, squad members in uniform or coaches shall not participate in a fight.

During the second half, players shall not participate in a fight.

**PENALTY—15 yards. For dead-ball fouls, 15 yards from the succeeding spot. Automatic first down for Team B fouls if not in conflict with other rules. Ejection for the remainder of the game and the first half of the next game [S7, S27 or S38, and S47]. For fighting in the last game of a season, those with remaining eligibility shall serve suspensions during the first game of the next season for which they are eligible.**

c. During either half, coaches or substitutes shall not leave their team area to participate in a fight, nor shall they participate in a fight in their team area.

**PENALTY—15 yards from the succeeding spot. Automatic first down for Team B fouls if not in conflict with other rules. Ejection for the remainder of the game and the first half of the next game [S7, S27 or S38, and S47]. For fighting in the last game of a season, those with remaining eligibility shall serve suspensions**

**during the first game of the next season for which they are eligible.**

ARTICLE 2. a. If the squad member, coach or player is ejected for fighting a second time during that season, they shall be ejected from that game and suspended for the remainder of the season.

b. If a second fighting suspension occurs in the final game of a season, they shall be suspended for the first game of the next season for which they are eligible. This suspension is considered to be the first fight of that season.

ARTICLE 3. The referee will notify (in writing) their assigning agency of all ejections for fighting. The assigning agency becomes responsible for implementation of the penalty.

## **SECTION 6. Flagrant Personal Fouls**

### **Player Ejection**

ARTICLE 1. When a player is ejected from the game due to a flagrant personal foul (Rule 2-10-3), that team's conference shall automatically initiate a video review for possible additional sanctions before the next scheduled game.

### **Foul Not Called**

ARTICLE 2. If subsequent review of a game by a conference reveals plays involving flagrant personal fouls that game officials did not call, the conference may impose sanctions prior to the next scheduled game.

---

# RULE 10

## Penalty Enforcement

---

### SECTION 1. Penalties Completed

#### How and When Completed

ARTICLE 1. a. A penalty is completed when it is accepted, declined or canceled according to rule, or when the choice is obvious to the referee.

- b. Any penalty may be declined, but a disqualified or ejected player must leave the game whether the penalty is accepted or declined (Rule 2-27-12).
- c. When a foul is committed, the penalty shall be completed before the ball is declared ready for play for any ensuing down.
- d. Penalties as stated are not enforced if in conflict with other rules.

#### Simultaneous With Snap

ARTICLE 2. A foul that occurs simultaneously with a snap or free kick is considered as occurring during that down (**Exception:** Rule 3-5-2-e).

#### Live-Ball Fouls by the Same Team

ARTICLE 3. When two or more live-ball fouls by the same team are reported to the referee, the offended team may elect only one of these penalties. Any player who commits a foul that mandates disqualification or ejection must leave the game.

#### Offsetting Fouls

ARTICLE 4. If live-ball fouls by both teams are reported to the referee, the fouls offset and the down is repeated (A.R. 10-1-4-I and VII). Any player who commits a foul that mandates disqualification or ejection must leave the game.

##### **Exceptions:**

1. When there is a change of team possession during a down, and the team last gaining possession had not fouled before last gaining possession, it may refuse offsetting fouls and thereby retain possession after completion of the penalty for its foul (A.R. 10-1-4-II-VII).
2. When all Team B fouls that occur before possession changes are governed by postscrimmage kick rules, Team B may refuse offsetting fouls and accept postscrimmage kick enforcement.
3. Rules 8-3-4-c and 3-1-3-g-3 (during a try or extra period after Team B possession).

#### Dead-Ball Fouls

ARTICLE 5. Penalties for dead-ball fouls are administered separately and in order of occurrence (A.R. 10-1-5-I-III) [**Exception:** When dead-ball unsportsmanlike or dead-ball personal fouls by both teams are reported to the



referee and none of the penalties have been completed, the yardage penalties cancel and the number or type of down established before the fouls occurred is unaffected. Any disqualified or ejected player must leave the game (Rules 5-2-6 and 10-2-2-a)].

### Live-Ball—Dead-Ball Fouls

ARTICLE 6. a. Live-ball fouls do not offset dead-ball fouls.

- b. When a live-ball foul by one team is followed by one or more dead-ball fouls (including live-ball fouls treated as dead-ball fouls) by an opponent or by the same team, the penalties are administered separately and in the order of occurrence (A.R. 10-1-6-I-VI).

### Interval Fouls

ARTICLE 7. Penalties for fouls that occur between the end of the fourth period and the start of the extra period for overtime, between possession series during an extra period, and between extra periods are enforced from the spot of the next possession series (**Exception:** Rule 10-2-5, A.R. 10-2-5-I-XII).

## SECTION 2. Enforcement Procedures

### Enforcement Spots

ARTICLE 1. a. For many fouls, the enforcement spot is specified in the statement of the penalty. When the enforcement spot is not specified in the statement of the penalty, the enforcement spot is determined by the Three-and-One Principle (Rules 2-33 and 10-2-2-c).

- b. Possible enforcement spots are: the previous spot, the spot of the foul, the succeeding spot, the spot where the run ends, and—for scrimmage kicks only—the postscrimmage kick spot.

### Determining the Enforcement Spot and the Basic Spot

ARTICLE 2. a. Dead-ball fouls. The enforcement spot for a foul committed when the ball is dead is the succeeding spot.

- b. Fouls by the offensive team behind the neutral zone. For the following fouls committed by the offensive team behind the neutral zone, the penalty is enforced at the previous spot: illegal use of hands, holding, illegal block and personal fouls (**Exception:** If the foul occurs in Team A's end zone the penalty is a safety.). However, see Rule 6-3-13 for offensive team fouls during scrimmage kick plays.
- c. The Three-and-One Principle (Rule 2-33) is as follows:
1. When the team in possession commits a foul behind the basic spot, the penalty is enforced at the spot of the foul.
  2. When the team in possession commits a foul beyond the basic spot, the penalty is enforced at the basic spot.
  3. When the team not in possession commits a foul either behind or beyond the basic spot, the penalty is enforced at the basic spot.
- d. The following are basic spots for the various categories of plays:
1. *Running plays.*
    - (a) *Previous spot*, when the related run ends behind the neutral zone.
    - (b) *End of the related run*, when the related run ends beyond the neutral zone.

- (c) *End of the related run*, on running plays that have no neutral zone.
- 2. *Running plays when the run ends in the end zone after change of team possession (not on a try).*
  - (a) *Succeeding spot*, when a foul occurs after a change of team possession in the end zone and the result of the play is a touchback.
  - (b) *Goal line*, when a foul occurs after a change of team possession in the field of play and the related run ends in the end zone. (**Exception:** Rule 8-5-1-Exceptions.)
  - (c) *Goal line*, when a foul occurs after a change of team possession in the end zone, the related run ends in the end zone, and the result of the play is not a touchback.
- 3. *Pass plays.*
  - Previous spot*, on legal forward pass plays.
- 4. *Kick plays.*
  - (a) *Previous spot*, on legal kick plays unless the foul is governed by postscrimmage kick rules.
  - (b) *Postscrimmage kick spot*, if the foul is governed by postscrimmage kick rules.
- e. For Team B fouls during a legal forward pass play: Penalty enforcement for Team B personal fouls and unsportsmanlike conduct is at the end of the last run when it ends beyond the neutral zone and there is no change of team possession during the down. (Rule 7-3-12) (A. R. 7-3-12-I and 9-1-2-III)

### Postscrimmage Kick Enforcement

ARTICLE 3. a. Under postscrimmage kick enforcement rules, fouls by Team B that satisfy the conditions in paragraph b (below) are treated as if Team B had been in possession at the time the foul was committed, even though by Rule 2-4-1-b-3 team possession had not changed.

- b. Postscrimmage kick enforcement applies *only* to fouls by Team B during a scrimmage kick and *only* under the following conditions:
  1. The kick is not during a try, a successful field goal, or in an extra period. (A.R. 10-2-3-IV)
  2. The ball crosses the neutral zone.
  3. The foul occurs before the end of the kick (A.R. 10-2-3-I, II, and V).
  4. Team B will next put the ball in play.

If these conditions are all met, the penalty is enforced according to the Three-And-One Principle. Team B is taken as the team in possession with the postscrimmage kick spot as the basic spot (Rule 10-2-2-c). See Rule 2-25-11 for the postscrimmage kick spot. (A.R. 10-2-3-I-VII)

### Fouls by Team A During Kicks

ARTICLE 4. Penalties for all fouls by the kicking team other than kick-catch interference (Rule 6-4) during a free kick play or a scrimmage kick play in which the ball crosses the neutral zone (except field goal attempts) are enforced by rule either at the previous spot as the basic spot (**Exception:** Penalty option is a safety for fouls in Team A's end zone.) or at the spot where the subsequent

dead ball belongs to Team B, at the option of Team B. (Rules 6-1-8 and 6-3-13)

### **Fouls During Or After A Touchdown, Field Goal or Try:**

ARTICLE 5. a. Fouls by the nonscoring team during a down that ends in a touchdown (not on the try).

1. Fifteen-yard penalties for personal fouls and for unsportsmanlike conduct fouls are enforced on the try, the succeeding kickoff or from the succeeding spot in extra periods at the option of the scoring team.
  2. Five- and 10-yard penalties are not enforced on the try or the succeeding kickoff. Such penalties are declined by rule unless enforcement is made possible by illegal touching of a kick during the down (A.R. 6-3-2-III-IV).
- b. Penalties for defensive pass interference fouls on a try from on or inside the three-yard line are enforced one-half the distance to the goal line. If the try is successful, the penalty is declined by rule.
- c. When a foul(s) occurs after a touchdown and before the ball is ready for play on the try or there was a live-ball foul treated as a dead-ball foul on the touchdown play, enforcement is on the try, the succeeding kickoff or from the succeeding spot in extra periods at the option of the offended team (A.R. 3-2-3-V).
- d. Penalties for live-ball fouls during field goal plays are administered by rule. When the field goal is successful, Team A shall have the option of canceling the score and have the penalty enforced from the previous spot or declining the penalty(ies) and accepting the score. Team A may accept the score with penalties for personal fouls and unsportsmanlike conduct fouls enforced on the succeeding kickoff or from the succeeding spot in extra periods. Penalties for live-ball fouls treated as dead-ball fouls and those for dead-ball fouls after a field goal down are enforced at the succeeding spot.
- e. Penalties for fouls during and after a try down are administered under Rules 8-3-3, 8-3-4, 8-3-5 and 10-2-5-b (A.R. 3-2-3-VI-VII).
- f. Distance penalties for fouls by either team may not extend a team's free kick restraining line behind its five-yard line. Penalties that would otherwise place the free kick restraining line behind a team's five-yard line are enforced from the next succeeding spot.

### **Half-Distance Enforcement Procedures**

ARTICLE 6. No distance penalty, including tries from on or inside the three-yard line, shall exceed half the distance from the enforcement spot to the offending team's goal line [**Exceptions:** (1) Defensive pass interference on scrimmage downs, other than the try (Rules 7-3-8 and 10-2-5-b); and (2) On the try, defensive pass interference when the ball is snapped from outside the three-yard line].

---

# RULE 11

## The Officials: Jurisdiction and Duties

---

### SECTION 1. Jurisdiction

ARTICLE 1. The officials' jurisdiction begins 90 minutes before the scheduled kickoff and ends when the referee declares the score final [S14]. It is expected that a minimum of three officials will take the field at 90 minutes before kickoff. All officials will be on the field at 40 minutes prior to kickoff.

ARTICLE 2. At 90 minutes before kickoff the playing field will be divided into an "L-shaped" configuration with the 30 yard-lines forming the "L" (See Appendix D). No later than 40 minutes before kickoff, the configuration will change to the "Buffer Zone" configuration, and no player shall enter the 10-yard buffer zone between the 45 yard-lines (See Appendix D).

### SECTION 2. Responsibilities

ARTICLE 1. a. The game shall be played under the supervision of five, six, seven or eight officials.

b. Officiating crews, including the Instant Replay Official, will be assigned from the same officiating organization (effective August 1, 2020).

ARTICLE 2. Officiating responsibilities and mechanics are specified in the current edition of the Football Officials Manual, published annually under the jurisdiction of the College Football Officiating, LLC (CFO). Officials are responsible for knowing and applying the material in the Manual.

---

# RULE 12

## Instant Replay

---

### SECTION 1. Purpose and Philosophy

#### Purpose

ARTICLE 1. Instant replay is a process whereby video review is used to confirm, overturn or let stand certain on-field decisions (Rule 12-3) made by game officials.

#### Philosophy

ARTICLE 2. The instant replay process operates under the fundamental assumption that the ruling on the field is correct. The replay official may overturn a ruling if and only if the video evidence (Rule 12-6-1-c) convinces the replay official beyond all doubt that the ruling was incorrect. Without such indisputable video evidence, the replay official must allow the ruling to stand. (*Exception:* Targeting rule 12-3-5-a)

### SECTION 2. Eligibility for Instant Replay

#### Participation

ARTICLE 1. a. Any member institution may use instant replay, but there is no requirement to do so. If instant replay is used, it must be used in full compliance with this rule.

- b. For any nonconference game, if the home team is using instant replay, the visiting team does not have the option of declining its use for that game. If the home team is not using instant replay, it is not required to honor a request by the visiting team that it be used.

### SECTION 3. Reviewable Plays

As a general rule, the position of the ball in relation to the goal line is always reviewable by instant replay.

#### Scoring Plays

ARTICLE 1. Reviewable plays involving a potential score include:

- a. A potential touchdown or safety. [*Exception:* Safety by penalty for fouls that are not specifically reviewable.]
- b. Field goal attempts if and only if the ball is ruled (a) below or above the crossbar or (b) inside or outside the uprights when it is lower than the top of the uprights. If the ball is higher than the top of the uprights as it crosses the end line, the play may not be reviewed.

## Passes

ARTICLE 2. Reviewable plays involving passes include:

- a. Pass ruled complete, incomplete or intercepted anywhere in the field of play or an end zone.
- b. Forward pass touched by a player (eligible or ineligible) or an official, including whether the touching is beyond or behind the line of scrimmage.
- c. Forward pass or forward handing when a ball carrier is or has been beyond the neutral zone.
- d. A forward pass or forward handing after a change of team possession.
- e. Pass ruled forward or backward.
  1. If the pass is ruled forward and is incomplete, the play is reviewable only if: The ball goes out of bounds; there is clear recovery of a loose ball in the immediate continuing action; or there is confirmation of the recovery by the officials on the field. If the replay official does not have indisputable video evidence as to which team recovers or the ball going out of bounds, the ruling of incomplete pass stands.
  2. If the replay official overturns an incomplete forward pass ruling and the ball is recovered, it belongs to the recovering team at the spot of the recovery and any advance is nullified.
- f. Location of the ball when it is obviously in the field of play or in the end zone and there is a ruling of intentional grounding on the field.

## Dead Ball and Loose Ball

ARTICLE 3. Reviewable plays involving potential dead balls and loose balls include:

- a. Loose ball by a potential passer ruled a fumble.
- b. Loose ball by a passer ruled incomplete forward pass when there is clear recovery or the ball goes out of bounds in the immediate continuing action after the loose ball.
  1. If the replay official does not have indisputable video evidence as to which team recovers, does not have confirmation of the recovery by the officials on the field, or the ball going out of bounds, the ruling of incomplete pass stands.
  2. If the replay official rules fumble and the ball is recovered, the ball belongs to the recovering team at the spot of the recovery and any advance is nullified.
- c. Live ball not ruled dead in possession of a ball carrier.
- d. Loose ball ruled dead (Rule 4-1-2-b-2), or live ball ruled dead in possession of a ball carrier, when the clear recovery of a loose ball occurs in the immediate continuing football action.
  1. If the ball is ruled dead and the replay official does not have indisputable video evidence as to which team recovers or confirmation of the recovery by the officials on the field, the dead-ball ruling stands.
  2. If the replay official rules that the ball was not dead, it belongs to the recovering team at the spot of the recovery and any advance is nullified.
- e. Ball carrier's forward progress, spot of fumble, or spot of out-of-bounds backward pass, with respect to a first down or the goal line.

- f. Catch or recovery of a fumble by a Team A player other than the fumbler before any change of possession during fourth down or a try.
- g. Ball carrier in or out of bounds. If a ball carrier is ruled out of bounds, the play is not reviewable, except as in Rules 12-3-1-a and 12-3-3-d.
- h. Catch, recovery or touching of a loose ball by a player in bounds or out of bounds.
- i. A loose ball touching on or beyond a sideline, goal line, or end line, touching a pylon, or breaking the plane of a goal line.
- j. Catch or recovery of a loose ball in the field of play or an end zone.
- k. Forward fumble that goes out of bounds with respect to a first down.

### **Kicks**

ARTICLE 4. Reviewable plays involving kicks include:

- a. Touching of a kick.
- b. Player beyond the neutral zone when kicking the ball.
- c. Kicking team player advancing a ball after a potential muffed kick/fumble by the receiving team.
- d. Scrimmage kick crossing the neutral zone.
- e. Blocking by players of the kicking team before they are eligible to touch the ball on an on-side kick.
- f. A player touching or recovering a kick or loose ball who is or has been out of bounds during the kick.
- g. Receiving team advancing after a fair catch signal.

### **Targeting**

ARTICLE 5 a. The replay official shall review all targeting fouls, Rules 9-1-3 and 9-1-4. For a player to be disqualified and the Targeting foul to be enforced, all elements of a Targeting foul must be confirmed by the Instant Replay Official. There is no option for stands as a part of a Targeting review. If any element of Targeting cannot be confirmed, then the Replay Official shall overturn the targeting foul.

Targeting elements include:

- 1. Rule 9-1-3:
  - (a) A player takes aim at an opponent for the purposes of attacking with forcible contact with the crown of the helmet.
  - (b) An indicator of targeting is present.
- 2. Rule 9-1-4:
  - (a) A defenseless opponent (Rule 2-27-14).
  - (b) A player takes aim at a defenseless opponent for the purposes of attacking with forcible contact to the head or neck area.
  - (c) An indicator of targeting is present.
- b. The replay official may create a targeting foul from the booth when all elements of targeting can be confirmed and the foul is not called by the officials on the field. Such a review may not be initiated by a coach's challenge.

## Miscellaneous

ARTICLE 6. Situations that may be addressed by the replay official:

- a. The number of players on the field for either team during a live ball.
- b. Clock adjustment and status when a ruling is reviewed and overturned with less than two minutes in the 2nd quarter or with less than two minutes in the 4th quarter.
- c. With less than one minute in either half and a replay review results in the on-field ruling being overturned, and the correct ruling would not have stopped the game clock, then the clock will be reset to the time the ball is declared dead by replay. The referee will subtract 10 seconds from the game clock and the game clock will start on the referee's signal. Either team may use a team timeout to avoid the runoff.
- d. Clock adjustment at the end of any quarter.

If the game clock expires at the end of any quarter, either during a down in which it should be stopped by rule through play when the ball becomes dead or after the down upon a request for an available team timeout, the replay official may restore time only under these conditions:

1. The replay official has indisputable video evidence that time should have remained on the game clock when the ball became dead or when the team timeout was granted.
  2. If time expires in a half, and the clock would start on the Referee's signal after review, there must be at least 3 seconds remaining when the ball should have been declared dead to restore time to the clock. With 2 seconds or 1 second remaining on the clock, the half is over unless Team A has a time out remaining (This does not impact situations when the clock is stopped and will remain stopped until the snap such as an incomplete pass or a ball carrier out of bounds.).
  3. In the fourth quarter only, to restore time, the score differential must be eight points or less (after a touchdown, all potential results of the try down must be considered).
  4. The replay official's video evidence includes the timeout signal by an official in the case where the game clock should have stopped for a requested team timeout.
- e. Correcting the number of a down.
    1. This includes the result of a penalty enforcement that includes an automatic first down or loss of down.
    2. The correction may be made at any time within that series of downs or before the ball is legally put in play after that series.
  - f. Any person who is not a player interfering with live-ball action occurring in the field of play (Rule 9-2-3).
  - g. An injured player at the initiation of the medical observer.

## Limitations on Reviewable Plays

ARTICLE 7. No other plays or officiating decisions are reviewable. However, the replay official may correct obvious errors that may have a significant impact on the outcome of the game, including those involving the game clock, whether or not a play is reviewable. This excludes fouls that are not specifically reviewable (See Article 8, following).



**Reviewable Fouls**

ARTICLE 8. The following plays are reviewable and the replay official may create a foul when there is no call by the on-field officials:

- a. Player making a forward pass or forward handoff when the player's entire body and the ball is or has been beyond the neutral zone or after a change of possession (Rule 12-3-2-c and -d).
- b. Player beyond the neutral zone when kicking the ball (Rule 12-3-4-b).
- c. Blocking by players of the kicking team before they are eligible to touch the ball on an onside kick (Rule 12-3-4-e).
- d. The number of players on the field for either team during a live ball (Rule 12-3-6-a).
- e. Illegal touching of a forward pass by an originally eligible receiver who has gone out of bounds or touching of a forward pass by an originally ineligible player (Rules 12-3-2-b and 12-3-3-h).
- f. A player touching or recovering a kick or loose ball who has been out of bounds and returned in bounds during the kick. (Rule 12-3-4-f).
- g. Forward pass that becomes illegal as a second pass after an on-field ruling of a backward pass is overturned (Rule 12-3-2-e).
- h. A clear and obvious targeting foul (Rule 12-3-5-b).

**SECTION 4. Instant Replay Personnel,  
Equipment and Location****Personnel**

ARTICLE 1. Instant replay personnel shall consist of the number of persons needed to operate the replay equipment within the necessary time constraints. There shall be a minimum of three persons to ensure that all plays are reviewed in an efficient and timely manner. Such persons are normally referred to as replay official, communicator and technician. Additional personnel may be used as needed.

**Equipment**

ARTICLE 2. a. The type of equipment used to carry out necessary instant replay duties shall be determined by each conference or member institution using instant replay.

- b. Additional equipment needed to allow instant replay personnel to communicate with the game referee when a game has been stopped for a play review shall be located on a sideline near the field of play and preferably outside a team area. Such equipment shall provide the game referee and the replay official a secure and private means of communication.
- c. A protected wireless official-to-official communication system (i.e., O2O) open only to the officiating crew, instant replay and conference officiating observer is permitted.

**Location**

ARTICLE 3. All equipment used to review a play during the replay process and the personnel using that equipment shall be located in a separate, secure location in the press box. This room shall not be available or accessible to any person not directly involved in instant replay. As an ongoing experiment, a

collaborative decision-making model during instant replay reviews that is in full compliance with Rule 12 is not limited to the press box of a stadium.

## SECTION 5. Initiating the Replay Process

### Game Stop

ARTICLE 1. There are two methods to stop a game to review a ruling on the field.

- a. The replay official and their crew shall review every play of a game. The replay official may stop a game at any time before the ball is next legally put in play (**Exception:** Rule 12-3-6-d) whenever they believe that:
  1. There is reasonable evidence to believe an error was made in the initial on-field ruling.
  2. The play is reviewable.
  3. The outcome of a review would have a direct, competitive impact on the game.
- b. The head coach of either team may request that the game be stopped and a play be reviewed by challenging the on-field ruling.
  1. A head coach initiates this challenge by taking a team timeout before the ball is next legally put in play (**Exception:** Rule 12-3-6-d) and informing the referee that they are challenging the ruling of the previous play. If a head coach's challenge is successful, they retain the challenge, which may be used only once more during the game. Thus, a coach may have a total of two challenges if and only if the initial challenge is successful.
  2. After a review has been completed, if the on-field ruling is overturned, that team's timeout will not be charged.
  3. After a review has been completed, and the on-field ruling is not overturned, the charged team timeout counts as one of the three permitted that team for that half or the one permitted in that extra period.
  4. A head coach may not challenge a ruling in which the game was stopped and a decision has already been made by the replay official. However, a head coach may challenge an aspect of the same play if that component of the play was not considered by the replay official as part of the initial review.
  5. If a head coach requests a team timeout to challenge an on-field ruling and the play being challenged is not reviewable, the timeout shall count as one of the three permitted team timeouts during that half of the game or the one permitted in that extra period.
  6. A head coach may not challenge an on-field ruling if all the team's timeouts have been used for that half or in that extra period.

### When To Stop a Game

ARTICLE 2. a. A game may be stopped, either by the replay official or by a head coach's challenge, at any time before the ball is next legally put in play (**Exception:** Rule 12-3-6-d).

- b. No game official may request that a game be stopped for a play to be reviewed.

## SECTION 6. Reviewing an On-Field Ruling

### Procedures

ARTICLE 1. a. When a game is to be stopped either by the replay official or by a head coach's challenge, the designated officials on the field will be notified by a paging system or other appropriate means.

- b. If the review is initiated by the replay official, the referee shall announce:  
"The ruling on the previous play is ... (brief description of ruling). The play is under further review."

If the game has been stopped due to a head coach's challenge, the referee shall announce:

"The (name of institution) head coach has challenged the ruling of (state the ruling). The play is under further review."

- c. All reviews shall be based upon video evidence provided by and coming directly from the televised production of the game or from other video means available to the replay official that is also available to the television producer.
- d. After the referee has conferred with the replay official and the review process has been completed, the referee shall make one of the following announcements:
1. If the video evidence confirms the on-field ruling:  
"After further review, the ruling on the field is confirmed."
  2. If there is no indisputable (conclusive) evidence to overturn the on-field ruling:  
"After further review, the ruling on the field stands." (**Exception:** 12-3-5-a — Stands is not an allowable ruling or targeting.)
  3. If the on-field ruling is overturned (Rule 12-7):  
"After further review, the ruling is [followed by a brief description of the video evidence]. Therefore, [followed by a brief description of the impact of the ruling]."
- e. If a ruling is overturned, the replay official shall supply the referee with all pertinent data as needed (next down, distance, yard line, position of the ball, clock status/adjustment) in order to resume play under the correct game conditions. If replay has all of the information required to overturn the on-field ruling, O2O may be utilized to facilitate the process.

### Restrictions

ARTICLE 2. a. There is no restriction on the number of times the replay official may stop a game for reviews.

- b. The expectation is that the replay official will not exceed two minutes to complete a review. If the review has end of game impact or has multiple aspects as a part of the review, it should be completed efficiently but will have no stated time limit.

## SECTION 7. Overturning an On-Field Ruling

### Criterion for Overturn

ARTICLE 1. To overturn an on-field ruling, the replay official must be convinced beyond all doubt by indisputable video evidence through one or more video replays provided to the monitor. [*Exception:* Targeting (Rule 12-3-5).]

---

# Appendix A

## Game-Official Guidelines for Serious On-Field Player Injuries

---

1. Players and coaches must go to and remain in the bench area. Direct players and coaches accordingly. Always ensure adequate lines of vision between the medical staffs and available emergency personnel.
2. Attempt to keep players a significant distance away from the seriously injured player or players.
3. Do not allow a player to roll an injured player over.
4. Do not allow players to assist a teammate who is lying on the field; i.e., removing the helmet or chin strap, or attempting to assist breathing by elevating the waist.
5. Do not allow players to pull an injured teammate or opponent from a pile.
6. Once the medical staff begins to assist an injured player, all members of the officiating crew should control the total playing field environment and team personnel, and allow the medical staff to perform services without interruption or interference.
7. Players and coaches should be appropriately controlled to avoid dictating medical services to the athletics trainers or team physicians, or taking up their time to perform such service.

*Note: Officials should have a reasonable knowledge of the location of emergency personnel equipment at all stadiums.*

(The NCAA Football Rules Committee expresses its appreciation to the National Football League for development of these guidelines.)

---

# Appendix B

## Lightning Policy

---

The NCAA provides detailed guidance on lightning (and other environmental hazards) in the NCAA Sports Medicine Handbook. Please consult the latest version of this handbook, which is available at [www.NCAA.org](http://www.NCAA.org).

---

# Appendix C

## Concussions

---

A concussion is a brain injury that may be caused by a blow to the head, face, neck or elsewhere on the body with an “impulsive” force transmitted to the head. **Concussions can occur without loss of consciousness or other obvious signs.** A repeat concussion that occurs before the brain recovers from the previous one (hours, days or weeks) can slow recovery or increase the likelihood of having long-term problems. In rare cases, repeat concussions can result in brain swelling, permanent brain damage and even death.

**Recognize and Refer:** To help recognize a concussion, watch for the following two events among your student-athletes during both games and practices:

1. A forceful blow to the head or body that results in rapid movement of the head.

**-AND-**

2. *Any change* in the student-athlete’s behavior, thinking or physical functioning (see signs and symptoms).

### SIGNS AND SYMPTOMS

#### Signs Observed By Coaching Staff

- Appears dazed or stunned
- Is confused about assignment or position
- Forgets plays
- Is unsure of game score or opponent
- Moves clumsily
- Answers questions slowly
- Loses consciousness (even briefly)
- Shows behavior or personality changes
- Can’t recall events before hit or fall
- Can’t recall events after hit or fall

#### Symptoms Reported By Student Athlete

- Headache or “pressure” in head
- Nausea or vomiting
- Balance problems or dizziness
- Double or blurry vision
- Sensitivity to light
- Sensitivity to noise
- Feeling sluggish, hazy, foggy or groggy
- Concentration or memory problems
- Confusion
- Does not “feel right”

An athlete who exhibits signs, symptoms or behaviors consistent with a concussion, either at rest or during exertion, should be **removed immediately from practice or competition** and should not return to play until cleared by an appropriate health care professional. Sports have injury timeouts and player substitutions so that student-athletes can get checked.

### IF A CONCUSSION IS SUSPECTED:

1. **Remove the student-athlete from play.** Look for the signs and symptoms of concussion if your student-athlete has experienced a blow to the head. Do not allow the student-athlete to just “shake it off.” Each individual athlete will respond to concussions differently.

2. **Ensure that the student-athlete is evaluated right away by an appropriate health care professional.** Do not try to judge the severity of the injury yourself. Immediately refer the student-athlete to the appropriate athletics medical staff, such as a certified athletic trainer, team physician or health care professional experienced in concussion evaluation and management.
3. **Allow the student-athlete to return to play only with permission from a health care professional with experience in evaluating for concussion.** Allow athletics medical staff to rely on their clinical skills and protocols in evaluating the athlete to establish the appropriate time to return to play. A return-to-play progression should occur in an individualized, step-wise fashion with gradual increments in physical exertion and risk of contact. Follow your institution's physician supervised concussion management protocol.
4. Develop a game plan. Student-athletes should not return to play until cleared by the appropriate athletics medical staff. In fact, as concussion management continues to evolve with new science, the care is becoming more conservative and return-to-play time frames are getting longer. Coaches should have a game plan that accounts for student-athletes to be out for at least the remainder of the day.

For further details please refer to the "NCAA Sports Medicine Handbook Guideline on Concussions" or online at [www.NCAA.org/health-safety](http://www.NCAA.org/health-safety) and [www.CDC.gov/Concussion](http://www.CDC.gov/Concussion).

*Reference to any commercial entity or product or service on this page should not be construed as an endorsement by the Government or its products or services.*



---

# **Appendix D**

## **Field Diagrams**

---

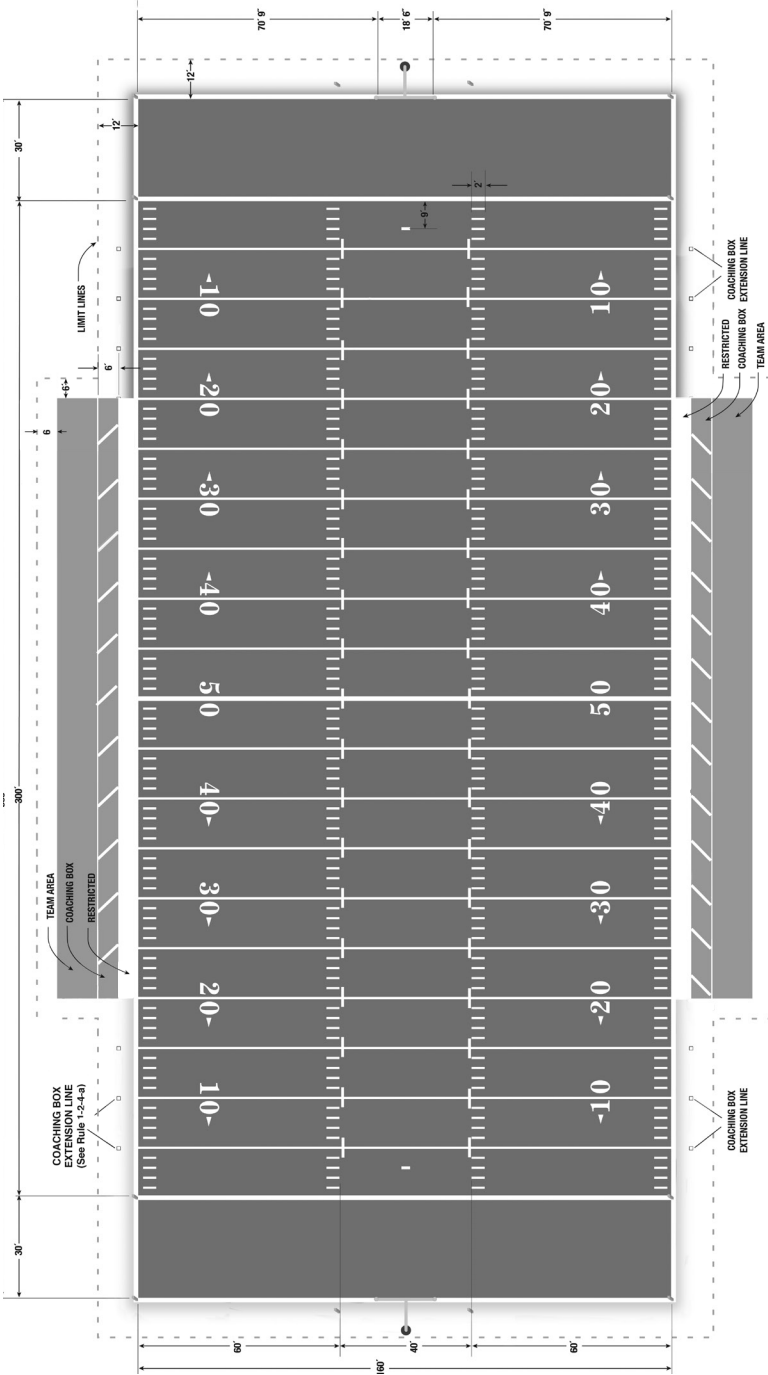

**PREGAME PROCEDURES:  
L-SHAPED CONFIGURATION**

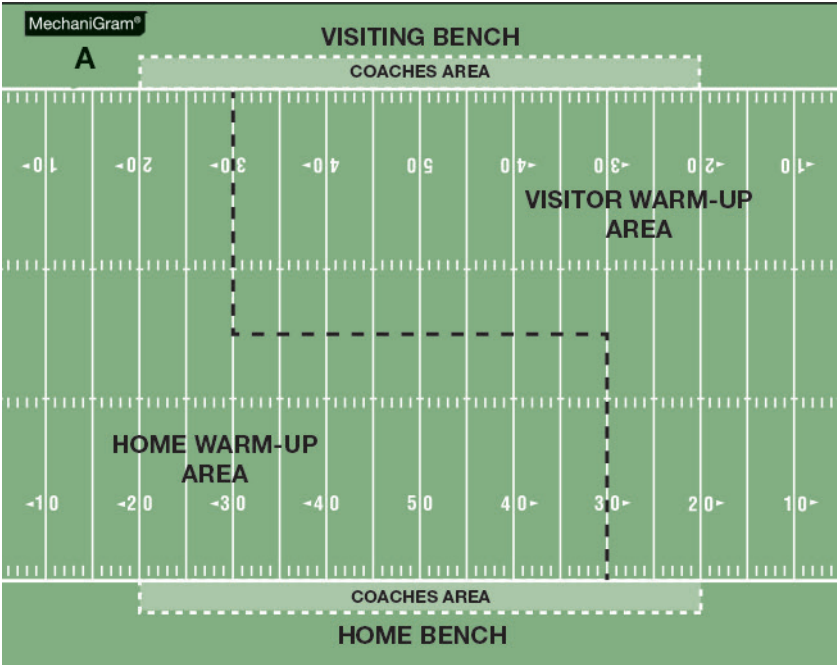

**PREGAME PROCEDURES:  
BUFFER ZONE CONFIGURATION**

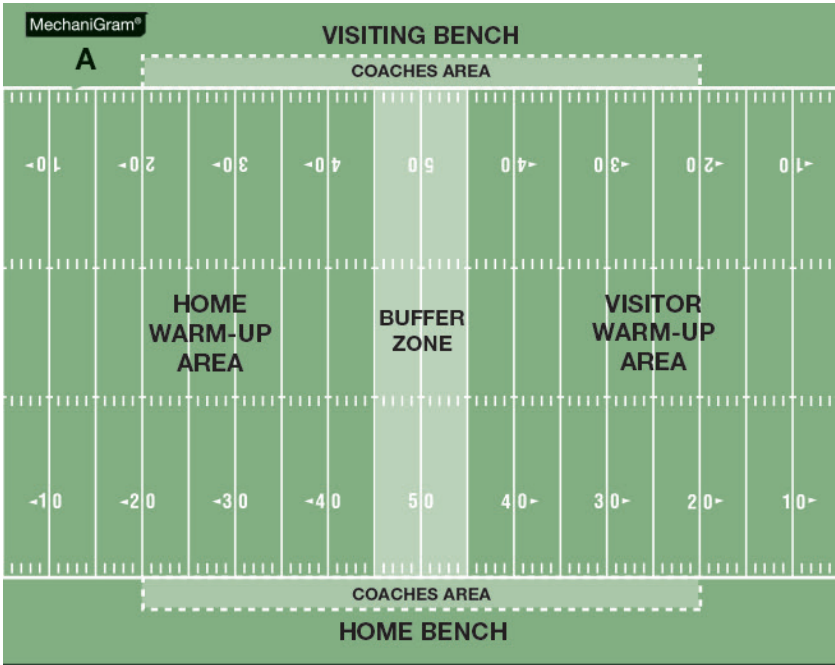

# TACKLE BOX

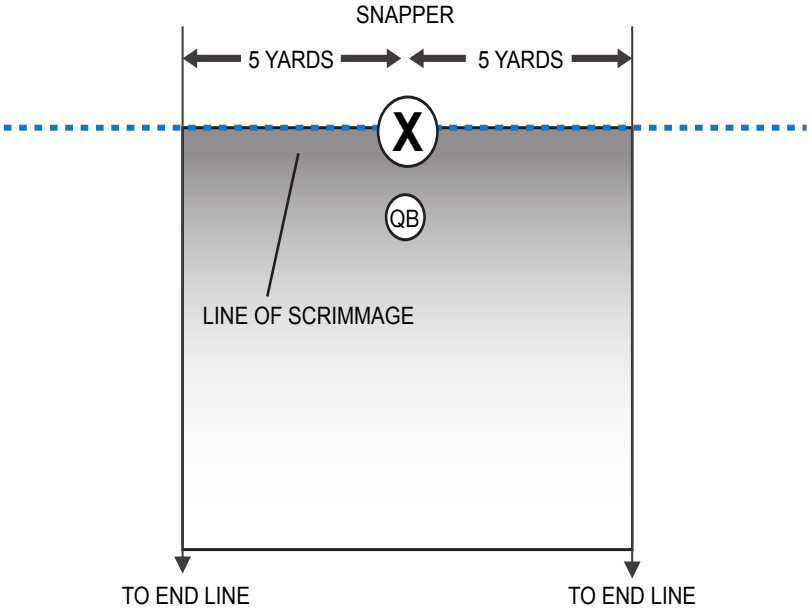

**PROPER PLACEMENT OF LOGO**

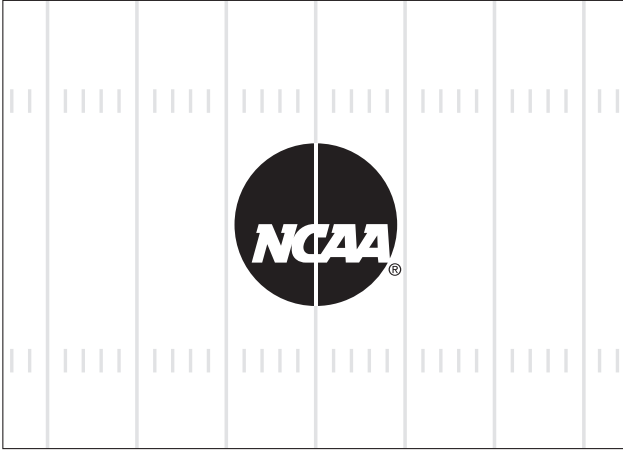

**Rule 1-2-1-f:** Contrasting decorative markings are permissible within the sidelines and between the goal lines. However, yard lines, goal lines and side lines must not be hidden. The markings also may not touch or enclose the hash marks or the numbers.

**IMPERMISSIBLE PLACEMENT OF LOGO**



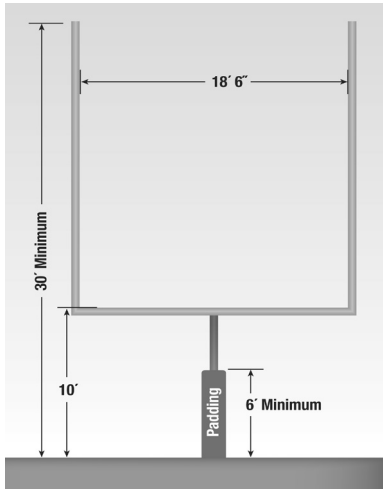

**GOAL POST DETAIL**

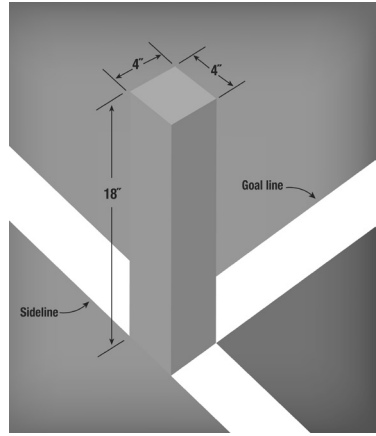

**PYLON DETAIL**

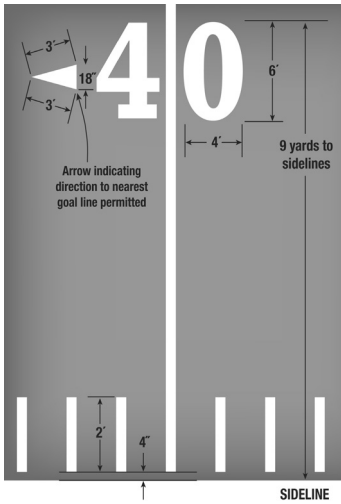

**RECOMMENDED YARD-LINE NUMBERING**

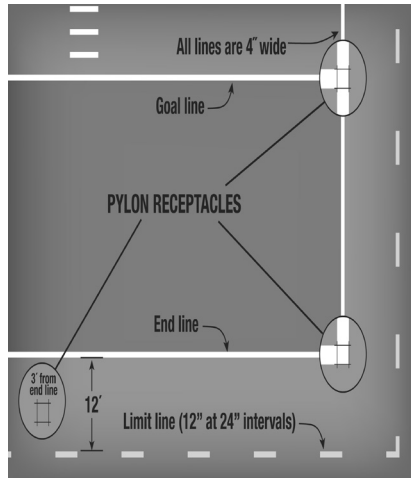

**END ZONE DETAIL**

---

# Appendix E

## Equipment: Additional Details

---

### A. Details Regarding Illegal Equipment

1. Hard or unyielding substances are permitted, if covered, only to protect an injury.
2. Hand and arm protectors (covered casts or splints) are permitted only to protect a fracture or dislocation.
3. Thigh guards may not be made of any hard substances, unless all surfaces are covered with material such as closed-cell vinyl foam that is at least 1/4-inch thick on the outside surface and at least 3/8-inch thick on the inside surface and the overlaps of the edges.
4. Shin guards must be covered on both sides and all edges with closed-cell, slow-recovery foam padding at least 1/2-inch thick, or an alternate material of the same minimum thickness having similar physical properties.
5. Therapeutic or preventive knee braces must be worn under the pants and entirely covered from direct external exposure.
6. There may be no projection of metal or other hard substance from a player's person or clothing.
7. Shoe cleats (Rule 9-2-2-e) must conform to the following specifications:
  - a. They may not be more than 1/2-inch in length (measured from tip of cleat to the shoe). (See below for an exception for detachable cleats.)
  - b. They may not be made of any material that burrs, chips or fractures.
  - c. They may not have abrasive surfaces or cutting edges.
  - d. Nondetachable cleats only may not be made of any metallic material.
  - e. Detachable cleats:
    - (1) Must have an effective locking device.
    - (2) May not have concave sides.
    - (3) If conical they may not have flat free ends not parallel to their bases or less than 3/8-inch in diameter or rounded free ends having arcs greater than 7/16-inch.
    - (4) If oblong they may not have free ends not parallel with bases or that measure less than 1/4-inch by 3/4-inch.
    - (5) If circular or ring-shaped they must have rounded edges and a wall at least 3/16-inch thick.
    - (6) If steel-tipped they must contain low carbon steel of 1006 material, case hardened to .005-.008 depth and drawn to Rockwell hardness of approximately C55.

*Note: The distance in paragraph (a) for detachable cleats may exceed 1/2 inch if the cleat is attached to a 5/32-inch or less raised platform wider than the base of the cleat and extended across the width of the shoe to within 1/4-inch or less*



*of the outer edges of the sole. A single toe cleat does not require a raised platform that extends across the width of the sole. The raised platform of the toe cleat is limited to 5/32-inch or less. The 5/32-inch or less is measured from the lowest point of the platform to the sole of the shoe.*

8. The facemask must be constructed of nonbreakable material with rounded edges covered with resilient material designed to prevent chipping, burrs or an abrasiveness that would endanger players.
9. Shoulder pads may not have the leading edge of the epaulet rounded with a radius more than one-half the thickness of the material used.
10. No equipment that endangers other players may be worn. Artificial limbs are permitted, provided:
  - (a) An artificial limb must not give the wearer any advantage in competition.
  - (b) If necessary, the artificial limb should be padded to rebound as a natural limb.
11. Insignia, logos, labels:
  - a. Uniforms and all other items of apparel (e.g., warm-ups, socks, headbands, T-shirts, wristbands, visors, hats or gloves) may bear only a single manufacturer's or distributor's normal label or trademark (regardless of the visibility of the label or trademark) not to exceed 2.25 square inches in area (e.g., rectangle, square, parallelogram) including any additional material (e.g., patch) surrounding the normal trademark or logo. See also Rule 1-4-6-d
  - b. No sizing, garment-care or other non-logo labels shall be on the outside of the uniform.
  - c. Professional league logos are prohibited.

## **B. New Equipment**

The NCAA Football Rules Committee is responsible for formulating the official playing rules for the sport. It is not responsible for testing or approving playing equipment for use in intercollegiate football.

Equipment manufacturers must develop playing equipment that meets the specifications established by the committee. The NCAA urges manufacturers to work with the various independent testing agencies to ensure the production of safe products. Neither the NCAA nor the committee certifies the safety of any football equipment. Only equipment that meets the dimensions and specifications in the NCAA Football Rules and Interpretations may be used in intercollegiate competition.

While the committee neither regulates the development of new equipment and nor sets technical or scientific standards for testing equipment, on occasion it may provide manufacturers with guidelines regarding the equipment-performance levels it considers consistent with the integrity of the game. The committee reserves the right to intercede to protect and maintain that integrity.

The NCAA Football Rules Committee suggests that manufacturers planning innovative changes in football equipment submit the equipment to the NCAA Football Rules Committee for review before production.

EXAMPLES OF PERMISSIBLE FACEMASKS

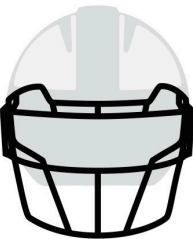
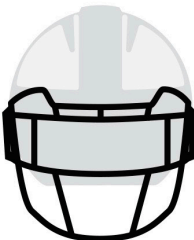
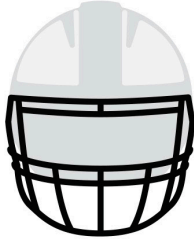
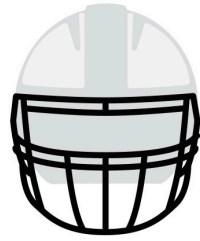
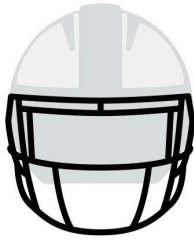
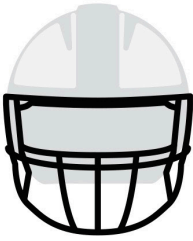

**EXAMPLES OF NONSTANDARD/OVERBUILT FACEMASKS**



**FRONT VIEW**

**BACK VIEW**

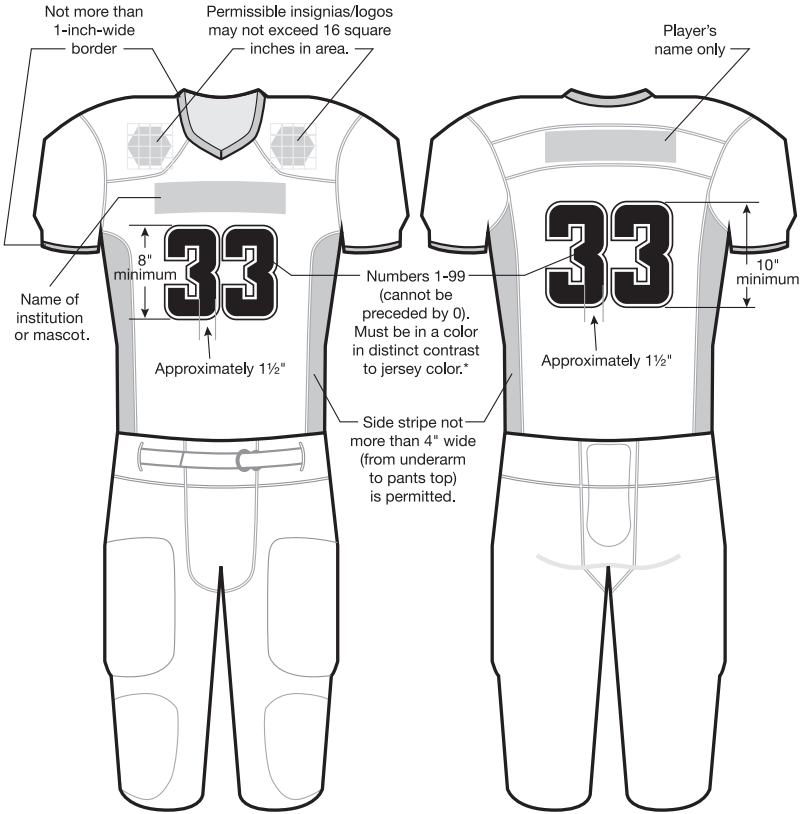

\* Numbering rules are intended to provide a clearly visible number for a variety of groups (e.g., coaches, media, fans, etc.). Therefore, numbers must be designed to be clearly visible from a press box in a variety of weather and lighting conditions.

# NCAA<sup>®</sup> UNIFORM AND EQUIPMENT RULES

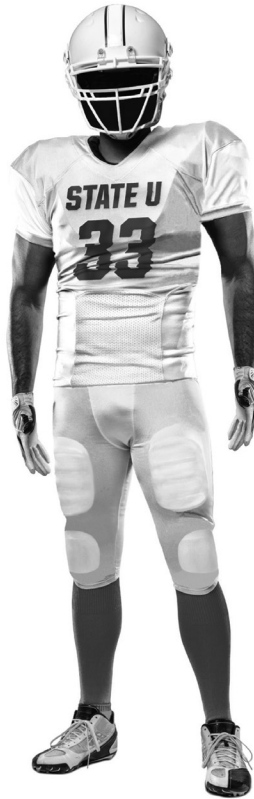
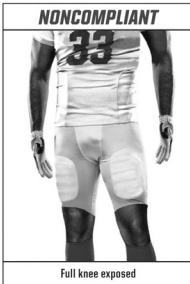
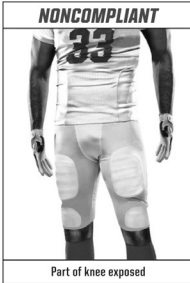
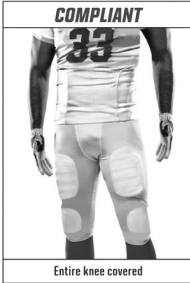

NCAA is a trademark of the National Collegiate Athletic Association.

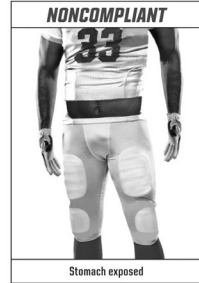

# Appendix F



## Official Football Signals

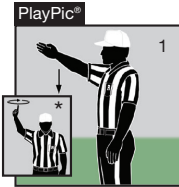

Ready for play  
\*Untimed down



Start the clock



Stop the clock

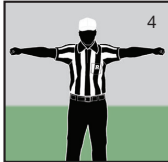

TV/radio timeout



Touchdown  
Field Goal



Safety



Dead-ball foul/  
touchback  
(move side to side)

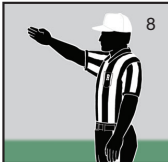

First down



Loss of down

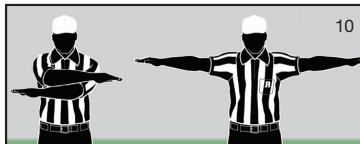

Incomplete pass/unsuccesful try or  
field goal/penalty declined/  
coin toss option deferred



Legal touching



Inadvertent whistle



Disregard flag



End of period

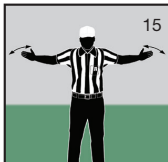

Sideline warning

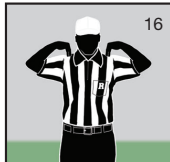

Illegal touching



Uncatchable pass

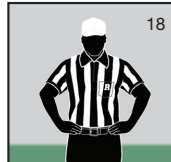

Offside B/Offside A  
or B on kickoff

PlayPics courtesy of **REFEREE** ([www.referee.com](http://www.referee.com))

## OFFICIAL SIGNALS

PlayPic®

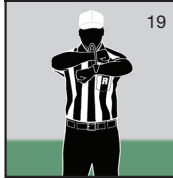

19  
False start/  
Encroachment A  
Illegal formation

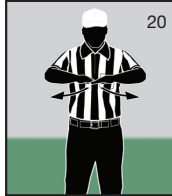

20  
Illegal motion (1 hand)  
Illegal shift (2 hands)

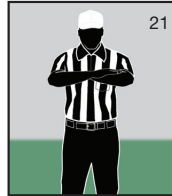

21  
Delay of game

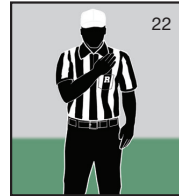

22  
Substitution  
infraction

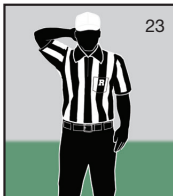

23  
Equipment violation

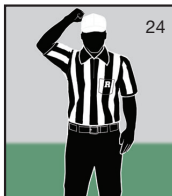

24  
Targeting

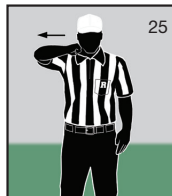

25  
Horse-collar

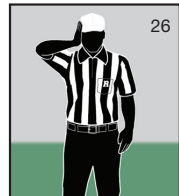

26  
Hands to the face

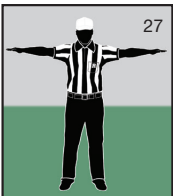

27  
Unsportsmanlike  
conduct

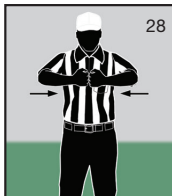

28  
Illegal blindside  
block

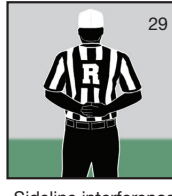

29  
Sideline interference  
Note: Face press box  
when giving signal.

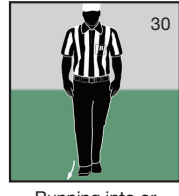

30  
Running into or  
roughing the kicker  
or holder

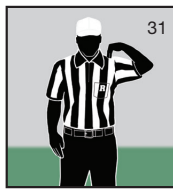

31  
Illegal batting/kicking  
(for illegal kicking, follow  
with a point toward foot)

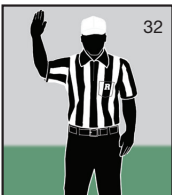

32  
Illegal fair catch

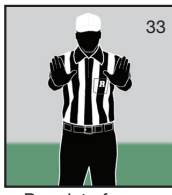

33  
Pass interference  
Kick-catching  
interference



34  
Roughing the passer

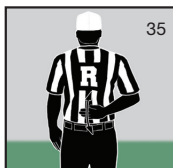

35  
Illegal pass  
Note: Face press box  
when giving signal.

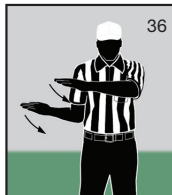

36  
Intentional grounding

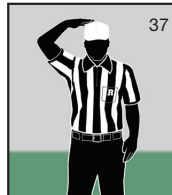

37  
Ineligible downfield  
on pass

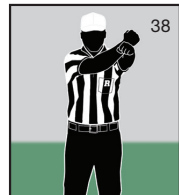

38  
Personal foul

# OFFICIAL SIGNALS

PlayPic®

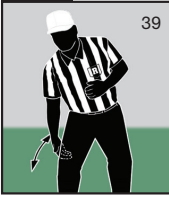

Clipping

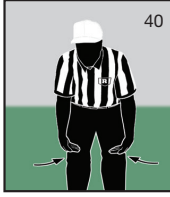

Block below the waist  
Illegal block



Chop block

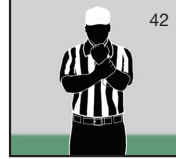

Holding  
Obstructing  
Illegal use of the  
hands or arms

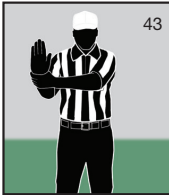

Illegal block  
in the back

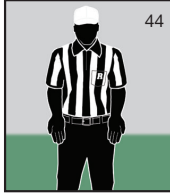

Helping the runner  
Interlocked  
interference

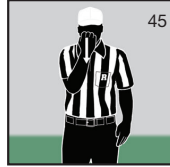

Grasping of  
face mask or  
helmet opening

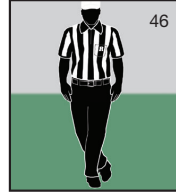

Tripping

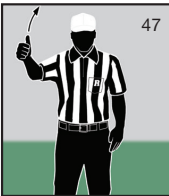

Disqualification

PlayPics courtesy of **REFEREE** ([www.referee.com](http://www.referee.com))



# Appendix G

## Summary of Penalties

LEGEND: "O" refers to official's signal number (see Code of Official's Signals); "R" is the rule number; "S" is the section number; "A" is the article number.

	O	R	S	A
<b>LOSS OF A DOWN</b>				
Illegal scrimmage kick [also loss of five yards].....	31*	6	3	10
Illegally handing ball forward [also loss of five yards].....	35*	7	1	6
Planned loose ball play [also loss of five yards].....	19*	7	1	7
Intentionally throwing backward pass out of bounds [also loss of five yards].....	35*	7	2	1
Illegal forward pass by Team A [also loss of five yards].....	35*	7	3	2
Intentionally grounding forward pass [spot of foul].....	36*	7	3	2
Forward pass illegally touched by player out of bounds.....	16*	7	3	4
Forward pass illegally touched.....	16*	7	3	11
Illegally batting ball [also loss of 10 yards] (see exceptions).....	31*	9	4	1
Illegally kicking ball [also loss of 10 yards] (see exceptions).....	31*	9	4	4
<b>LOSS OF FIVE YARDS</b>				
Alteration of playing surface for an advantage.....	19	1	2	9
Improper numbering.....	23	1	4	2
Coin-toss infractions.....	19	3	1	1
Delay after three timeouts expended.....	21	3	4	2
Illegal delay of the game.....	21	3	4	2
Advancing a dead ball.....	21	3	4	2
Disconcerting offensive signals.....	21	3	4	2
Substitution rules infractions.....	22	3	5	2
More Than Eleven Players in the formation or during the play.....	22	3	5	3
Putting ball in play before it is ready.....	21	4	1	4
Exceeding 40/25-second count.....	21	4	1	5
Infraction of free kick formation.....	18, 19	6	1	2
Team A blocking during a free kick.....	19	6	1	2
Player out of bounds when ball free-kicked.....	19	6	1	2
Team A player illegally goes out of bounds (free kick).....	19	6	1	2
Free kick out of bounds.....	19	6	2	1
Illegal kick [also loss of down if by Team A].....	31*	6	3	10
Team A player illegally goes out of bounds (scrimmage kick).....	19	6	3	12
Defensive Linemen—3-on-1 on field goal formation.....	19	6	3	14
Taking more than two steps after fair catch.....	21	6	5	2
Illegal snap.....	19	7	1	1
Snapper's position and ball adjustment.....	19	7	1	3
Team A not within nine-yard marks after ready.....	19	7	1	3
False start or simulating start of a play.....	19	7	1	3
Encroachment (offense) at snap.....	19	7	1	3
Player out of bounds when ball is snapped.....	19	7	1	4
Offensive player illegally in motion at the snap.....	20	7	1	4
Illegal Formation.....	19	7	1	4
Illegal formation due to numbering exception.....	19	7	1	4
Illegal shift.....	20	7	1	4
Offside (defense).....	18	7	1	5
Abrupt defensive actions.....	21	7	1	5
Interference with opponent or ball.....	18	7	1	5
Defensive player charging unabated toward a back.....	19	7	1	5
Defensive player out of bounds at the snap.....	19	7	1	5
Illegally handing ball forward [also loss of down if by Team A].....	35*	7	1	6

Planned loose ball play [also loss of down].....	19*	7	1	7
Intentionally throwing backward pass out of bounds [also loss of down if by Team A].....	35*	7	2	1
Player on scrimmage line receiving snap.....	19	7	2	3
Illegal forward pass [also loss of down if by Team A] .....	35*	7	3	2
Ineligible receiver downfield .....	37	7	3	10
Forward pass illegally touched [also loss of down] .....	16	7	3	11
Running into kicker or holder.....	30	9	1	16
Game Administration Interference [second and third infractions].....	21,29	9	2	5
Interlocked interference or helping ball carrier .....	44	9	3	2

### LOSS OF 10 YARDS

Home team delay .....	21	3	4	1
Illegal block by fair-catch signaller.....	40	6	5	4
Illegal use of hands or arms (offense).....	42	9	3	3
Holding or obstruction (offense).....	42	9	3	3
Illegal block in the back (offense) .....	43	9	3	3
Locked hands.....	42	9	3	3
Illegal use of hands (defense) [first down] .....	42	9	3	4
Holding or obstruction (defense) [first down].....	42	9	3	4
Illegal block in the back (defense) .....	43	9	3	4
Holding or obstruction (loose ball).....	42	9	3	7
Illegally batting loose ball [also loss of down].....	31*	9	4	1
Illegally batting a backward pass.....	31	9	4	1&2
Batting ball in possession by player in possession .....	31	9	4	3
Illegally kicking ball [also loss of down].....	31*	9	4	4

### LOSS OF 15 YARDS

Marking ball.....	27	1	3	3
Numbers changed to deceive the opponent .....	27	1	4	2
Home Jersey Worn Without Permission .....	27	1	4	5
Illegal signal devices [also ejection].....	27	1	4	10
Team not ready to play at start of either half .....	21	3	4	1
Rapid substitutions to opponents' disadvantage.....	22, 27	3	5	2
Illegal Wedge Formation .....	27	6	1	10
Interference with opportunity to catch a kick.....	33	6	4	1
Tackling or blocking fair-catcher.....	38	6	5	5
Offensive pass interference.....	33	7	3	8
Defensive pass interference [first down] .....	33	7	3	8
Striking; tripping [first down] .....	38, 46	9	1	2
Targeting/Initiating Contact w/Crown of Helmet [first down] [Also Disqualification].....	38, 24, 47	9	1	3
Targeting/Initiating Contact to head/neck area of a defenseless player [first down] [Also Disqualification] .....	38, 24, 47	9	1	4
Clipping [first down] .....	39	9	1	5
Blocking below the waist [first down] .....	40	9	1	6
Late Hit/action out of bounds [first down].....	38	9	1	7
Helmet / Face Mask Fouls [first down].....	38,45	9	1	8
Continuous contact to the helmet; Hands to the face [first down].....	38,45	9	1	8
Roughing the passer [first down] .....	34	9	1	9
Chop Blocking [first down].....	41	9	1	10
Leverage/Leaping [first down].....	38	9	1	11
Defensive restrictions .....	27	9	1	11
Fouling an opponent obviously out of the play [first down].....	38	9	1	12
Hurdling [first down].....	38	9	1	13
Illegal contact against the snapper [first down] .....	38	9	1	14
Horse-Collar Tackle [first down].....	38, 25	9	1	15
Roughing the kicker or holder [first down] .....	38, 30	9	1	16
Kicker simulating being roughed.....	27	9	1	16
Continued Participation Without a Helmet .....	38	9	1	17
Blind-Side Block .....	38	9	1	18
Obscene or vulgar language.....	27	9	2	1
Persons illegally on the field .....	27	9	2	1
Player not returning ball to official .....	27	9	2	1

Provoking ill will .....	27	9	2	1
Unsportsmanlike conduct .....	27	9	2	1
Persons leaving team area.....	27	9	2	1
Illegal return of disqualified player .....	27	9	2	1
Noise by persons subject to rules .....	27	9	2	1
Concealing the ball.....	27	9	2	2
Simulated replacements or substitutions .....	27	9	2	2
Equipment to confuse opponents .....	27	9	2	2
Intentionally contacting an official [also ejection] .....	27	9	2	4
Game Administration Interference [fourth and subsequent] .....	27, 29	9	2	5
Fighting [also ejection] .....	27, 38, 47	9	5	1

### LOSS OF HALF DISTANCE TO GOAL LINE

If distance penalty exceeds half the distance (except on defensive pass interference).....	—	10	2	6
---	---	----	---	---

### OFFENDED TEAM'S BALL AT SPOT OF FOUL

Defensive pass interference (if less than a 15-yard penalty) [first down] .....	33	7	3	8
--	----	---	---	---

### CHARGED TIMEOUT FOR A VIOLATION

Not wearing mandatory equipment .....	23	1	4	8
Wearing illegal equipment.....	23	1	4	8
Head coach's conference .....	21	3	3	4
Head coach's challenge.....	21	12	5	1
Illegal cleats [Also ejection] .....	23	9	2	2

### VIOLATION

Illegal touching of free kick by kicking team.....	16	6	1	3
Illegal touching of scrimmage kick.....	16	6	3	2
Scrimmage-kick-batting exception .....	16	6	3	11

### WARNING

Game Administration Interference [first infraction].....	15	9	2	5
--	----	---	---	---

### EJECTION

Prohibited signal devices.....	47	1	4	10
Flagrant fouls .....	47	9	1	1
Two unsportsmanlike fouls.....	47	9	2	6
Illegal cleats.....	47	9	2	2
Contacting an official.....	47	9	2	4
Use of tobacco .....	47	9	2	7
Fighting .....	47	9	5	1

### DISQUALIFICATION

Targeting/Initiating Contact w/Crown of Helmet .....	38	9	1	3
Targeting/Initiating Contact to head/neck of a defenseless player .....	38	9	1	4

### AUTOMATIC FIRST DOWNS (DEFENSIVE FOULS)

Pass interference.....	33	7	3	8
Striking; tripping.....	46,38	9	1	2
Targeting/Initiating Contact w/Crown of Helmet .....	38	9	1	3
Contact to head/neck area of a defenseless player .....	38	9	1	4
Clipping .....	39	9	1	5
Blocking below the waist .....	40	9	1	6
Late Hit/action out of bounds .....	38	9	1	7
Helmet / Face Mask Fouls .....	38,45	9	1	8
Roughing the passer.....	34	9	1	9
Chop Blocking .....	41	9	1	10
Leverage/Leaping .....	38	9	1	11
Fouling an opponent obviously out of the play .....	38	9	1	12
Hurdling .....	38	9	1	13
Illegal contact against the snapper.....	38	9	1	14

Horse-Collar Tackle .....	38, 31	9	1	15
Roughing the kicker .....	38, 30	9	1	16
Unsportsmanlike Conduct .....	27	9	2	1
Holding .....	42	9	3	4
Fighting .....	27, 38, 47	9	5	1

#### WHEN-IN-QUESTION RULES

Catch or recovery not completed .....	—	2	4	3
Block below waist .....	—	2	3	2
Chop block .....	—	2	3	3
Block in the back .....	—	2	3	4
Ball not touched on kick or forward pass .....	—	2	11	4
Ball is accidentally kicked (touched) .....	—	2	16	1
Forward pass rather than backward pass .....	—	2	19	2
Forward pass and not fumble .....	—	2	19	2
It is a catchable forward pass .....	—	2	19	4
Stop clock for injured player .....	—	3	3	5
Forward progress stopped .....	—	4	1	3
Kick-catch interference .....	—	6	4	1
It is a catchable forward pass .....	—	7	3	8
Touchback rather than safety .....	—	8	5	1
Targeting .....	—	9	1	3, 4
A player is defenseless .....	—	9	1	4
Twisting, turning or pulling face mask (helmet opening) .....	—	9	1	8
Roughing kicker rather than running into .....	—	9	1	16

#### REFEREE'S DISCRETION

Penalty for unfair acts .....	27	9	2	3
-------------------------------	----	---	---	---

---

# Appendix H

## Accommodations for Student-Athletes with Disabilities

---

The NCAA encourages participation by student-athletes with disabilities (physical or mental) in intercollegiate athletics and physical activities to the full extent of their interests and abilities. An NCAA member institution will have the right to seek, on behalf of any student-athlete with a disability participating on the member's team, a reasonable modification or accommodation of a playing rule, provided that the modification or accommodation would not:

1. Compromise the safety of, or increase the risk of injury to, any other student-athlete;
2. Change an essential element that would fundamentally alter the nature of the game; or
3. Provide the student-athlete an unfair advantage over the other competitors.

To request any such modification or accommodation, the member's director of athletics, or his/her designee, must submit a rule waiver request, in writing, to the secretary-rules editor. Such written request should describe:

- a. The playing rule from which relief is sought;
- b. The nature of the proposed modification or accommodation;
- c. The nature of the student-athlete's disability and basis for modification or accommodation; and
- d. The proposed duration of the requested modification or accommodation.

Additionally, each request should be accompanied by documentation evidencing the student-athlete's disability (e.g., a medical professional's letter). Upon receipt of a complete waiver request, the secretary-rules editor will consult with NCAA staff, the applicable sport/rules committee, other sport governing bodies, and/or outside experts, to conduct an individual inquiry as to whether the requested modification or accommodation can be made. In making this assessment, the NCAA may request additional information from the member institution. The secretary-rules editor will communicate the decision in writing (which may be via email) to the requesting member institution. If the request is granted, the member institution should be prepared to provide the written decision to the officiating staff, opposing coach(es), and tournament director (if applicable) for each competition in which the student-athlete will participate. NCAA members are directed to consult Guideline 2P of the NCAA Sports Medicine Handbook for further considerations regarding participation by student-athletes with impairment.



---

# Part II:

## Interpretations

---

A football rule interpretation, or approved ruling (A.R.), is an official decision on a given statement of facts. It serves to illustrate the spirit and application of the rule.

Any approved rulings that have been altered significantly are shaded for ease of reference. All new approved rulings are listed in the front of this section and are shaded.

STEVE SHAW, Secretary-Rules Editor

---

# Table of Contents

## for Approved Rulings

---

	<i>page</i>
List of New and Modified Approved Rulings.....	<a href="#">FI-3</a>
Rule 1—The Game, Field, Players and Equipment.....	<a href="#">FI-4</a>
Rule 2—Definitions.....	<a href="#">FI-8</a>
Rule 3—Periods, Time Factors and Substitutions.....	<a href="#">FI-12</a>
Rule 4—Ball in Play, Dead Ball, Out of Bounds.....	<a href="#">FI-24</a>
Rule 5—Series of Downs, Line to Gain .....	<a href="#">FI-27</a>
Rule 6—Kicks.....	<a href="#">FI-30</a>
Rule 7—Snapping and Passing the Ball.....	<a href="#">FI-41</a>
Rule 8—Scoring.....	<a href="#">FI-54</a>
Rule 9—Conduct of Players and Others Subject to the Rules.....	<a href="#">FI-62</a>
Rule 10—Penalty Enforcement.....	<a href="#">FI-78</a>



---

# List of New and Modified Approved Rulings

---

## NEW APPROVED RULINGS

**Rule 1**

1-4-7-VI  
1-4-7-VII

**Rule 2**

2-4-3-IV

**Rule 4**

4-1-3-IV

**Rule 7**

7-3-12-II

**Rule 9**

9-1-6-I  
9-1-6-II  
9-2-2-VIII  
9-3-4-II

## MODIFIED APPROVED RULINGS

**Rule 3**

3-3-2-VII

**Rule 5**

5-1-3-I  
5-1-3-II

**Rule 6**

6-5-4-I  
6-5-4-II

**Rule 7**

7-3-11-II

**Rule 8**

8-2-1-X  
8-3-1-II

**Rule 9**

9-1-3-II  
9-1-4-II  
9-1-4-VI  
9-1-6-IV – IX  
9-1-15-I  
9-1-16-VII  
9-3-4-I

**Rule 10**

10-2-3-VII

---

# RULE 1

## The Game, Field, Players and Equipment

---

### Section 2. The Field

#### Dimensions and Markings—ARTICLE 1

##### Approved Ruling 1-2-1

- I. A commercial entity or individual has purchased naming rights to the stadium, and a separate corporate entity has purchased naming rights to the field. **RULING:** If both corporate entities are to be displayed on the field, then each of the corporate entity's name/company-specific font or logo may utilize separately one of the four available flanking locations, for a total of two locations.

### Section 3. The Ball

#### Administration and Enforcement—ARTICLE 2

##### Approved Ruling 1-3-2

- I. On fourth down, kicker A1 enters the field with an approved game ball and asks the referee to substitute it for the ball used during the previous down. **RULING:** Substitution of the ball is not permitted.

### Section 4. Players and Playing Equipment

#### Players' Numbering—ARTICLE 2

##### Approved Ruling 1-4-2

- I. The Team A player who started the game wearing jersey number 77 enters the game wearing number 88. **RULING:** The player must report to the Referee who, without stopping the game or play clock, uses his microphone to announce the change and the relevant flank official informs the opposing head coach. If A88 fails to report it is a foul for unsportsmanlike conduct.

#### Specifications: Mandatory Equipment—ARTICLE 4

##### Approved Ruling 1-4-4

- I. A player or players of a team wear tights that cover their legs. **RULING:** Legal. For those players that wear tights, they must be of the same design and color.

#### Jersey Design, Color and Numerals—ARTICLE 5

##### Approved Ruling 1-4-5

- I. The home team is wearing red jerseys with orange numerals. In the judgment of the officials, the numerals and the body of the jersey do not contrast enough to make the numbers readily visible. The referee asks the home team head coach to change to a legal jersey. The head coach tells the referee that his team will not change into different jerseys. **RULING:** After the ball is marked ready for play for the opening kickoff, the referee charges the home team with a timeout for illegal jerseys. In addition, there will be a 15-yard penalty at the succeeding spot following the kickoff starting each half. If the kickoff is returned for a touchdown, the penalty is assessed either on the try or at the succeeding kickoff. For each quarter that they continue to wear the jerseys, the team is charged with a timeout after the ball is declared ready for play and before the ball is put in play for the first play of that quarter. If a team has no timeouts remaining, a delay of game penalty will be enforced.

### **Illegal Equipment—ARTICLE 7**

#### **Approved Ruling 1-4-7**

- I. A33 is wearing a bandanna under his helmet, with part of the bandanna protruding from underneath the back of the helmet. **RULING:** Illegal equipment. Bandannas may be worn under the helmet as long as no part of the bandanna is visible when the helmet is in place. The visible bandanna is considered a uniform attachment (1-4-7-h). A33 must leave the game for at least one down and may not return until the bandanna is removed or completely hidden under the helmet. Team A may request a team timeout, if one is available, to prevent A33 from missing a down, but the bandanna must be hidden or removed.
- II. At the end of a down, B55's shoulder pad has become exposed and is not covered by the jersey. **RULING:** Illegal equipment. Because the pad became exposed through play, B55 is not required to leave the game. The pad must be covered by the jersey before the ball is next put into play.
- III. Both teams come onto the field before the game wearing colored jerseys. The visiting team has not obtained written agreement from the home team to wear other than white jerseys, or if such agreement has been obtained the home team's conference has not certified that the jerseys are of contrasting colors. **RULING:** Foul by the visiting team for violation of the jersey-color rule. After the ball is marked ready for play for the opening kickoff, the referee charges the visiting team with a timeout for illegal jerseys. In addition, there will be a 15-yard penalty at the succeeding spot following the kickoff starting each half. If the kickoff is returned for a touchdown, the penalty is assessed either on the try or at the succeeding kickoff. For each quarter that they continue to wear the jerseys, the team is charged with a timeout after the ball is declared ready for play and before the ball is put in play for the first play of that quarter. If a team has no timeouts remaining, a delay of game penalty will be enforced. (1-4-5-b)
- IV. As Team A is about to break its huddle, the Referee notices that A35 is wearing an overbuilt facemask. **RULING:** A35 must leave the game for one down to get a legal facemask. Team A may use an available charged timeout in order that A35 not miss a down, but he may not play with the illegal facemask.

- V. Each member of the offensive line is wearing a towel, all of which are white, 4" by 12", with a small team logo. The snapper's towel also has a large skull-and-cross-bones symbol. **RULING:** It is legal for any player to wear a towel. The towels are all legal except the snapper's. He must leave the game for at least one down and may not return until the towel is removed or replaced with one that is legal. Team A may keep him in the game by using a charged timeout, but he may not wear the illegal towel. (Rules 1-4-6-a and 1-4-8)
- VI. A player writes or paints advertisements, messaging and/or inscriptions on their shoes and plans to wear them during the game. **RULING:** Not allowed by rule. Appendix E, A-11 allows for uniforms and all other items of apparel to bear only a single manufacturer's or distributor's normal label or trademark not to exceed 2.25 square inches in area. To allow the student athlete's voice to be heard, the Playing Rules Oversight Panel (PROP) has expanded the size of the insignia patch to 16 square inches to allow players to celebrate or memorialize persons, events or social justice causes (Rule 1-4-6-d). Additionally, the student athlete as authorized by the institution or conference, is allowed other names/words intended to celebrate or memorialize persons, events, or other causes on the back of the jersey/uniform where the player's name is traditionally located. The names/words may vary by team member.
- VII. A player enters the field during pre-game warmups after the officials' jurisdiction begins wearing a tee shirt with (a) an advertisement with the shirt including a number that is readily visible; (b) a social justice message with the shirt including a number that is readily visible; (c) no number readily visible. **RULING:** The tee shirt in (a) is not allowed by rule as advertisements are not allowed on the uniform or any items of apparel (Exception – Post-season game as outlined in Rule 1-4-5); (b) legal; (c) not allowed as per Rule 3-1-1-c. There is no yardage penalty for (a) and (c) but the player must leave the playing enclosure. Officials are encouraged to seek out the Head Coach, Equipment Manager or Game Management to take the appropriate action.

### **Mandatory and Illegal Equipment Enforcement—ARTICLE 8** **Approved Ruling 1-4-8**

- I. After the ball is ready for play, an official identifies a player(s) who is obviously not wearing a mouthpiece. **RULING:** The player(s) must leave the game for at least one down and may not return until properly equipped with a mouthpiece. The player(s) may remain in the game by spending an available team timeout, but they may not play until properly equipped.
- II. Late in the first half, Team B has used its three timeouts. At the end of a play the line judge notices that B44, a player who participated in the previous play, is equipped with an eye shield that is either tinted or not clear. **RULING:** Equipment violation. B44 must leave the game for at least one down and may not return if he is wearing an illegal eye shield.
- III. When the ball is dead after a scrimmage down, the Umpire notices that linebacker B55 has an exposed back pad at waist level, which apparently became exposed through play during the previous down. **RULING:** B55

is not required to leave the game, but he must cover the exposed pad with his jersey before the next down.

### **Prohibited Field Equipment—ARTICLE 11**

#### **Approved Ruling 1-4-11**

- I. The Head Coach of the home team is unable to attend the game in person and wants to monitor the TV broadcast and (a) call in plays via cell phone to the offensive coordinator and (b) use a virtual application (Zoom, Microsoft Teams, etc.) to communicate with the team in the locker room. **RULING:** Rule 1-4-11-b is specific and allows only voice communication between the press box and the team area, therefore in (a) the coach could not call into the press box or the sideline for anything related to coaching purposes. Rule 1-4-11-a would prohibit the use of technology including computers to be used for coaching purposes and this would include all virtual types of communication back to a team during the game. Consequently in (b) any virtual session with the team would not be allowed. This prohibition would begin at 90 minutes before the scheduled kickoff when the officiating crew assumes jurisdiction of the game and would include the time between periods until the end of the game when the Referee declares the score final.

---

# RULE 2

## Definitions

---

### Section 4. Catch, Recovery, Possession

#### Catch, Interception, Recovery—ARTICLE 3

##### Approved Ruling 2-4-3

- I. B1 attempts to catch a punt (no fair catch signal) that crosses the neutral zone, strikes his shoulder (a muff) and bounces into the air. The ball does not touch the ground. Airborne A1 receives the ball in flight and first returns to the ground out of bounds. **RULING:** Team B's ball at the spot where the ball crossed the sideline. First and 10.
- II. On third down, B1 blocks a Team A scrimmage kick that goes into the air and does not cross the neutral zone. The ball does not touch the ground. A1 jumps and grasps the ball in flight and first returns to the ground out of bounds. **RULING:** Team B's ball at the spot where the ball crossed the sideline. First and 10 (Rule 6-3-7).
- III. Airborne A3 receives a pass at Team A's 40-yard line. While still airborne, he is contacted by B1 and comes to the ground out of bounds with the ball at Team A's 37-yard line. **RULING:** Incomplete pass (Rule 7-3-7-a).
- IV. Receiver A88 is near the sideline, stretching to catch a legal forward pass. As A88 is going to the ground in the act of catching the pass, (a) A88 gains firm control of the ball with the toes down in bounds and falls out of bounds, maintaining firm control; (b) A88 gains firm control of the ball with toes down in bounds, bobbles the ball while airborne, regains firm control before landing out of bounds and maintains firm control when landing; (c) A88 gains firm control of the ball with toes down in bounds, falls out of bounds and loses firm control of the ball when contacting the ground. **RULING:** (a) Catch by A88. (b) Incomplete pass. (c) Incomplete pass.

### Section 8. Fair Catch

#### Invalid Signal—ARTICLE 3

##### Approved Ruling 2-8-3

- I. During Team A's punt from the A-20, receiver B44 points at the grounded punt at midfield. As B44 points at the ball, (a) he keeps his hands below his shoulders with no waving motion; (b) he keeps his hands below his shoulders and has a waving motion; (c) he has his hands just above the shoulders with no waving motion. **RULING:** Rule 2-8-3 states that any waving motion that does not meet the criteria for a valid signal is an invalid signal. Additionally, by interpretation the receiver is allowed to point at a

kick as long as his hands remain below the shoulder and there is no waving motion. Both (b) and (c) would be an Invalid Fair Catch Signal. In (a), this would not be considered a signal at all, and Team B would retain the right to recover the ball and advance.

## Section 11. Fumble, Muff: Batting and Touching the Ball; Blocking a Kick

### Touching—ARTICLE 4

#### Approved Ruling 2-11-4

- I. A punt is rolling along the ground near players A44 and B27 who are engaged. (a) The ball bounces against the B27's leg and is then recovered by A55 at the B-35. (b) A44 blocks B27 into the ball which is then recovered by A55 at the B-35. **RULING:** (a) Team A's ball, first and 10 at the B-35. The ball rolled into B27's leg but A44's contact did not cause him to touch the ball. Not forced touching. (b) Forced touching because the block by A44 caused B27 to touch the ball. Illegal touching by A55. Team B's ball at that point.

## Section 12. Lines

### Goal Lines—ARTICLE 2

#### Approved Ruling 2-12-2

- I. Team A's untouched scrimmage kick strikes the ground in the field of play and breaks the plane of Team B's goal line. While the ball is in the air over the end zone, A81, who is either on the one-yard line or in the end zone, bats the ball into the field of play. **RULING:** Violation for illegal touching (Rule 6-3-11). Team B may accept the result of the play or next snap the ball at its 20-yard line (Exception: Rule 8-4-2-b).

### Restraining Lines—ARTICLE 5

#### Approved Ruling 2-12-5

- I. A free kick breaks the plane of Team B's restraining line. While the ball is in the air, A1, who is behind Team B's restraining line, touches the ball. **RULING:** Legal touching (Rule 6-1-3-b).

## Section 16. Kicks; Kicking the Ball

### Place Kick—ARTICLE 4

#### Approved Ruling 2-16-4

- I. On a free kick to start a game, the kicker uses the toe of a teammate for a tee or builds a tee with a mound of dirt or sod. **RULING:** Illegal kick. Dead-ball foul. Penalty—Five yards from the succeeding spot.

### Kickoff—ARTICLE 6

#### Approved Ruling 2-16-6

- I. After a Touchdown and successful 2 point try, Team A trails 24 – 22 with 0:55 left in the 4th quarter. Team A intends to try an on-side free kick from the A-35. Kicker A90 holds the ball as if he will attempt a drop kick. A-90 then tosses the ball up in the air and the ball bounces just behind Team A's

restraining line and then A90 kicks the ball after it bounces several feet into the air. **RULING:** Illegal Kick. Dead-ball foul. Penalty – Five yards from the succeeding spot. This kick does not meet the requirements of a Drop Kick as required in Rule 2-16-3. For a legal drop kick the kicker must drop the ball and kick it as it touches the ground. Since Rule 2-16-6 only allows a place kick or a drop kick for a kickoff, this kick is not a legal kick. The penalty enforcement follows the current Approved Ruling 6-1-2, I.

### Scrimmage Kick Formation—ARTICLE 10

#### Approved Ruling 2-16-10

- I. At the snap Team A has four linemen numbered between 50-79 and three linemen numbered outside this range. A potential kicker is eight yards deep but there is no potential holder. **RULING:** Illegal formation. Team A is not in a scrimmage kick formation and does not have the required number of linemen with proper jersey numbers.

## Section 19. Passes

### Forward and Backward Pass—ARTICLE 2

#### Approved Ruling 2-19-2

- I. A1 intends to throw a forward pass, but B1 bats the ball from his hand before A1's hand starts forward. **RULING:** Fumble (Rule 2-11-1).

### Crosses Neutral Zone—ARTICLE 3

#### Approved Ruling 2-19-3

- I. QB A12 throws a legal forward pass, and receiver A88 first touches the pass when the ball is 1 ½ yards beyond the neutral zone. The receiver's back foot is not beyond the neutral zone. **RULING:** The legal forward pass has crossed the neutral zone. Rule 2-19-3-a states that a pass has crossed the neutral zone when it strikes anything beyond the neutral zone. By Rule 2-19-3-b, A88 as a player is not beyond the neutral zone. Nevertheless, by Rule 2-19-3-a the pass has crossed the neutral zone since it was beyond the neutral zone when A88 touched it. The guiding principle on a pass crossing the neutral zone is the location of the ball when it is first touched.

## Section 23. Snapping the Ball

#### Approved Ruling 2-23-1

- I. Fourth and goal on Team B's five-yard line. A55's legal snap is muffed by A12 and (a) any player of Team A recovers and advances the ball into the end zone, or (b) a player of Team B recovers and advances the ball. **RULING:** The snap is a backward pass and may be advanced by any player. (a) Touchdown. Since this is a backward pass and not a fumble there is no restriction on a Team A player recovering and advancing the ball. (b) Ball continues in play.



## Section 27. Team and Player Designations

### Disqualified Player—ARTICLE 12

#### Approved Ruling 2-27-12

- I. A player is disqualified for a targeting foul in the second half. **RULING:** The player is not allowed to play in the first half of his team's next game. However, he is allowed to participate in pregame warmups with his team. He may not participate in the first half, but may remain in the team area. (Rules 9-1-3 and -4)
- II. A player is disqualified for a targeting foul in the second half of his team's last game of the regular football season. **RULING:** He is not allowed to play in the first half of his team's next game, whenever that is. If the game is the final one of the regular season, he may not play the first half of any postseason game. If his team does not play a postseason game, he may not play in the first half of the first game of the following season (assuming he has eligibility remaining). (Rules 9-1-3 and -4)
- III. Player number 21 for the home team was disqualified late in the 3rd quarter for Targeting and legally remains in the team area. Between the end of the 3rd quarter and the start of the 4th quarter, number 21 for the home team is flagged in the team area for Unsportsmanlike Conduct. **RULING:** Dead ball foul, 15-yard penalty from the succeeding spot. Automatic first down for fouls by Team B if not in conflict with other rules. Number 21 is ejected from the game and must leave the playing enclosure. Any player that has been disqualified and is subsequently penalized for Unsportsmanlike Conduct is automatically ejected.

## Section 30. Play Classification

### Running Play—ARTICLE 4

#### Approved Ruling 2-30-4

- I. A21 catches a forward pass with his knees on the ground. The passer is roughed during the pass. **RULING:** A21's catch started a running play, which ended immediately. Penalize 15 yards from the end of the run, first down for Team A.
- II. Third and 10. A21 catches a forward pass and fumbles when tackled after gaining nine yards. The fumble is recovered by grounded A24 five yards in advance of the fumble. During the pass, the passer is roughed. **RULING:** Penalize 15 yards from the spot of recovery by A24 (end of last run), first down for Team A.

---

# RULE 3

## Periods, Time Factors and Substitutions

---

### Section 1. Start of Each Period

#### Pregame—ARTICLE 1

##### Approved Ruling 3-1-1

- I. After the officials' jurisdiction has begun, a few home team players enter the playing enclosure without their game jersey, and do not have their numeral readily visible. **RULING:** The players with no game jersey or numeral readily visible must immediately leave the playing enclosure. The head coach or assistant coach(es) on the field may help with this situation.

#### Extra Periods—ARTICLE 3

##### Approved Ruling 3-1-3

- I. Other than on the try, Team B scores a touchdown after intercepting a forward pass, intercepting or recovering a backward pass or fumble, or returning a blocked field goal attempt. **RULING:** Period and game are ended, and Team B is the winner.
- II. During the first possession series of a period, Team B intercepts a forward pass, or intercepts or recovers a fumble or a backward pass, and does not score a touchdown. **RULING:** Team A's possession series is ended and Team B starts its series. Team B becomes Team A when the referee declares the ball ready for play.
- III. During the first possession series of a period, Team A's field goal attempt is blocked and does not cross the neutral zone. Team A recovers the ball and runs for a touchdown. **RULING:** Six points for Team A. Team B begins its possession series after the try.
- IV. Team A's field goal attempt is blocked and does not cross the neutral zone. A23 recovers the ball and is tackled beyond the line to gain. **RULING:** Team A retains the ball to continue its possession series. First and 10.
- V. On first, second or third down, Team A's field goal attempt is blocked and does not cross the neutral zone. A23 recovers the ball and is tackled short of the line to gain. **RULING:** Team A's ball, next down.
- VI. During the first possession series of a period, Team B gains possession and then loses possession to Team A, which (a) scores a touchdown; (b) does not score a touchdown. **RULING:** (a) The score counts. In both (a) and (b), Team A's possession series ends and Team B begins its possession series.
- VII. During the first possession series of a period, Team A fumbles into Team B's end zone on second down of a series. Team B recovers and downs the ball in

- its end zone. **RULING:** Team A's possession series is ended. Team B begins its possession series.
- VIII. During the first possession series of a period, B10 intercepts a forward pass on his six-yard line and downs the ball in his end zone. **RULING:** Safety: two points for Team A. Team A's possession series is over. Team B will put the ball in play, first and 10 on the 25-yard line at the same end of the field.
- IX. Team A's field goal attempt is untouched beyond the neutral zone until B17 muffs it at the five-yard line. A75 recovers at the three-yard line. **RULING:** Team A's possession series continues; first down for Team A at the three-yard line.
- X. On the first possession series of a period, Team A scores a touchdown. On the try, Team B intercepts a pass and returns it for a two-point touchdown. **RULING:** Team B starts its possession series at the 25-yard line with Team A leading in the overtime 6-2.
- XI. After the end of the first possession series by Team A, Team B commits a dead-ball foul. **RULING:** Team B starts its possession series on the 40-yard line, first and 10.
- XII. During the first possession series of a period, A12 throws a forward pass and Team A is flagged for an illegal shift. B25 intercepts the pass, and B38 a) clips or (b) commits a flagrant personal foul before B25 crosses Team A's goal line. **RULING:** Score not allowed. The fouls cancel and the down is not repeated. Team A's possession series is ended, and a) Team B begins its possession series at the 25-yard line; b) B38 is ejected and Team B begins its possession series at the 40-yard line.
- XIII. During the second possession series of a period, B25 intercepts a pass and carries the ball across Team A's goal line. During the run, B79 clips at midfield. **RULING:** No touchdown. Either the game is over, or the next period will start with first and 10 at the 25-yard line, since the penalty is not carried over.
- XIV. During the first possession series B37 intercepts a forward pass and has a clear field to the goal line when he makes an obscene gesture toward the nearest opponent. **RULING:** Team B's score is canceled and the penalty is carried over. Team B begins its possession series on the 40-yard line, first and 10 (Rules 3-1-3 and 3-1-3-g-1 and 2).

## Section 2. Playing Time and Intermissions

### Timing Adjustments—ARTICLE 2

#### Approved Ruling 3-2-2

- I. At halftime the score is 56-0. The coaches and the referee agree that the third and fourth quarters should be shortened to 12 minutes each. The coaches also request that the second half be played with a "running clock," i.e., that the game clock not be stopped. **RULING:** The remaining quarters may be shortened to 12 minutes each. However, the "running clock" is not allowed; normal clock rules apply for the entire game.

## Extension of Periods—ARTICLE 3

### Approved Ruling 3-2-3

- I. During the extension of a period after the ball is ready for play and before the snap, Team A commits a foul. **RULING:** Dead-ball foul. Team A is penalized for the foul and is entitled to complete the down.
- II. Time expires during Team A's free kick. A1 is offside on the kick. **RULING:** Penalty—Five yards from the previous spot, the end of Team B's run, or the touchback spot, and the period is extended. Repeat the free kick or Team B is awarded an untimed down.
- III. Time expires during Team A's attempted field goal. Team B was offside. **RULING:** Penalty—Five yards from the previous spot, the period is extended (Rules 10-2-2-d-4-a).
- IV. A Team A player interferes with the opportunity to catch a kick (not a try) during a down in which time expires. **RULING:** Penalty—15 yards from the spot of the foul. The period is extended.
- V. Team A scores a touchdown during a down in which time expires. After the touchdown, but before the try, either team fouls. **RULING:** The period is extended only for the try. The penalty may be enforced on the try or the succeeding kickoff, or the succeeding spot in extra periods.
- VI. Team A scores a touchdown during a down in which time expires. During Team A's successful try, Team B fouls. **RULING:** The period is not extended for the kickoff. Team A may accept the penalty and repeat the try, or decline the penalty and accept the score. Penalties for personal fouls and unsportsmanlike conduct are enforced on the subsequent kickoff or the succeeding spot in extra periods.
- VII. Team A scores a touchdown during a down in which time expires. After the try ends, either team commits a dead-ball foul. **RULING:** The try may be repeated for an accepted penalty if a live-ball foul occurred during the try; the penalty for the dead-ball foul will then also be enforced on the repeated try. The period is not extended to enforce a penalty for a dead-ball foul. If accepted, this penalty must be enforced on the kickoff to start the next period or at the succeeding spot in extra periods.
- VIII. Time expires in the first half on a play in which A12 is beyond the neutral zone when he completes a pass to A88 in Team B's end zone. **RULING:** Team B accepts the penalty to nullify the score, and at the option of the offended team the period is not extended because the penalty includes loss of down. The first half ends.

## Timing Devices--ARTICLE 4

### Approved Ruling 3-2-4

- I. When the ball is dead after a running play that ends out of bounds, the 40-second play clock is started. The umpire receives the ball from the line judge, and as he is placing it on the ground, he sees that it is one of Team B's balls. He tosses the ball to the line judge who attempts to get a Team A ball from the ball boy. **RULING:** If the play clock reads 25 or less before the correct ball is in from the sideline and ready for play, the Referee declares a timeout and signals to reset the play clock to 25 seconds. When the correct ball is ready for play he signals to start the play clock and the game clock.

- II. When the ball is dead after a running play that ends in the side zone, the officials have difficulty getting the ball in to the hash mark. As the play clock nears 25, the Umpire places the ball on the ground, and by the time the officials are ready, the play clock is somewhat below 25 when the Umpire steps away. **RULING:** Without stopping the game clock, the Referee gives the “pump” signal to indicate that the play clock is to be reset to 25. If the play clock is quickly reset to 25, the game clock does not stop. Only if the play clock operator does not quickly respond to the Referee’s “pump” signal will the Referee declare a timeout, signal for the play clock to be set at 25, and then signal to start both the play and game clocks.
- III. Team A scores a Touchdown and the 40 second play clock is started. Without stopping the game, the Referee receives positive confirmation from the Replay Official that the Touchdown is good. The play clock displays: (a) 25 or more seconds, or (b) 24 or less seconds. **RULING:** The Referee (a) signals to clear the Center Judge and allow the ball to be snapped. (b) The Referee will signal the play clock be reset to 25 seconds, and will then signal to clear the Center Judge and allow the ball to be snapped.
- IV. Team A scores a Touchdown and the 40 second play clock is started. With less than 25 seconds on the play clock, Team A Head Coach or Team Captain requests the ball be moved to the left hash mark. **RULING:** The officials will not honor the request. Team A may call a timeout to relocate the ball unless preceded by a Team A foul or offsetting fouls.

### **Minimum Time For A Play After Spiking The Ball—ARTICLE 5**

#### **Approved Ruling 3-2-5**

- I. Late in a quarter Team A, out of timeouts, makes a first down, stopping the clock which reads 0:03. Team A intends to spike the ball and run an additional play. The referee appropriately blows his whistle and signals, which starts the game clock. The quarterback takes the snap and raises the ball high over his head before throwing it directly to the ground. The game clock shows 0:00. **RULING:** Time in the quarter has expired. Although there were 3 seconds on the game clock when the referee signaled it to start, there is no guarantee of enough time to run an additional play other than spiking the ball. The offense must execute the spike in a timely manner.

## **Section 3. Timeouts: Starting and Stopping the Clock**

### **Timeout—ARTICLE 1**

#### **Approved Ruling 3-3-1**

- I. On third and 2-1/2, A45 fumbles a live ball after gaining three yards. The officials cannot determine who has recovered the fumble, so the line judge signals the clock to stop while the ball is being located. A45 is found to be in possession of the ball and (a) has not made his line to gain or (b) has made his line to gain. **RULING:** The 40-second clock starts when the ball is declared dead. (a) The referee immediately will signal the game clock to start. (b) The game clock will start on the referee’s signal when the ball is ready for play.
- II. On second and 14, A45 gains six yards and is downed with the ball in his possession. The linesman, mistaking the back stake of the line-to-gain chain for the front stake, erroneously signals the clock to stop. **RULING:** As soon as

the error is detected by any official, the signal to start the clock shall be given by the game official detecting the error.

- III. Team A fumbles or the ball is loose after a backward pass. Several players dive on the ball, creating a “pile.” **RULING:** The covering official(s) shall stop the clock and the 40-second clock shall start. Upon positive knowledge of who recovered, the referee will point in the direction governed by possession and start the game clock (a) immediately if Team A has recovered short of the line to gain (no first down), or (b) on the snap if Team B has recovered.
- IV. A shoelace, padlace, jersey, number or equipment breaks or tears. **RULING:** No referee’s discretionary timeout permitted for repair or replacement.

## Starting and Stopping the Clock—ARTICLE 2

### Approved Ruling 3-3-2

- I. Fourth and six. Team A’s running play, which ends inbounds, gains (a) eight yards or (b) five yards. B1 is offside during the play. **RULING:** (a) Team A’s ball. First and 10. The clock starts on the referee’s signal. (b) Team A’s ball. Fourth and one. The clock starts on the referee’s signal. (Rules 3-3-2-e-1 and e-4)
- II. Fourth and four. Team A’s running play, which ends inbounds, gains (a) six yards or (b) three yards. B1 is offside during the play. **RULING:** (a) Team A’s ball, first and 10. The clock starts on the referee’s signal. (b) Team A’s ball, first and 10 after accepting the penalty. The clock starts on the referee’s signal.
- III. Third and four. Team A’s pass is intercepted by B1, who is downed inbounds. B2 was offside during the play. **RULING:** Team A’s ball. First and 10. The clock starts on the referee’s signal. Although the clock was stopped to award Team B a first down, Team B will not next snap the ball.
- IV. Late in the second or fourth quarter, ball carrier A37 goes out of bounds. When the game clock is stopped it reads (a) 2:00, or (b) 1:59. **RULING:** (a) The game clock starts on the referee’s signal when the ball is ready for play. (b) The game clock starts on the snap.
- V. Late in the second or fourth quarter, Team A has second and eight. B44 intercepts a legal forward pass and carries the ball out of bounds. B79 is in the neutral zone at the snap. When the game clock is stopped it reads (a) 2:00, or (b) 1:59. **RULING:** Team A accepts the penalty and retains possession of the ball. In both (a) and (b) the game clock starts on the referee’s signal, because Team B will not next snap the ball. In (b) if Team B is leading, the clock will start on the snap.
- VI. Fourth and eight at the A-12, late in the fourth quarter. The punt is blocked and the ball does not cross the neutral zone. At the A-10, back A22 recovers the ball and throws a forward pass to eligible A88 who is tackled at the B-3. The game clock reads 0:03. **RULING:** Team A’s ball at the B-3, first and goal. The game clock starts on the snap because of the legal kick play. (Rules 3-3-2-d-8, 3-3-2-e-1, 3-3-2-f)
- VII. Free Kick @ A-35. Team A executes an on-side kick. After the ball has traveled 10 yards, (a) B21 gives a valid fair catch signal and makes a clean catch; (b) A80 is first to touch the ball and makes a clean legal catch or recovery; (c) B21 catches or recovers the ball and immediately goes to the ground; (d) B21 makes a clean recovery with their knees on the ground. **RULING:** The ball

is declared dead and, (a) No time will run off the clock; (b) No time will run off the clock; (c) the clock operator shall start the clock when the ball is legally touched and will stop the clock when the ball is declared dead (Rule 3-3-2-a); (d) No time will run off the clock.

- VIII. Third and five at the B-15 late in the fourth quarter, with Team A trailing 10-7. Quarterback A11 rolls out and is at the B-12 when he throws a forward pass that is incomplete. When the ball is dead the game clock shows 0:13. Team B accepts the penalty for the illegal forward pass. **RULING:** Fourth and seven at the B-17. Team B has the option for a 10-second runoff. Assuming that Team B accepts the runoff, the game clock is set at 0:03 and starts on the referee's signal.

### **Suspending the Game—ARTICLE 3**

#### **Approved Ruling 3-3-3**

- I. A game between teams from different conferences has been suspended in the middle of the third quarter very late at night due to weather. It is clear that the game cannot be resumed. The directors of athletics for the participating teams are unable to arrive at an agreement on which option should be in effect. **RULING:** The outcome of the game is determined by the conference policy of the home team.

### **Charged Team Timeouts—ARTICLE 4**

#### **Approved Ruling 3-3-4**

- I. Before the snap, a legal substitute of either team running from the bench requests a timeout before being within the nine-yard marks. He then requests a timeout again after being within the nine-yard marks. **RULING:** Initial timeout request not granted. Second request granted (Rule 7-1-3-b).

### **Injury Timeout—ARTICLE 5**

#### **Approved Ruling 3-3-5**

- I. At the end of a play, with the game clock running, the referee notices that A22 is bleeding. **RULING:** The referee stops the clock and declares an injury timeout. A22 leaves the field of play or the end zone for treatment by appropriate medical personnel. Unless there is also an injury to a Team B player the play clock is set to 25 seconds and starts on the ready-for-play signal (Rule 3-2-4-c-4).
- II. After being treated for a bleeding or oozing wound, A22 (A.R. 3-3-5-1) attempts to enter the game before the next snap. **RULING:** A22 must remain out of the game for at least one play. In any event, he may return only on the approval of his team professional medical personnel.
- III. B52's jersey has blood spots on it. **RULING:** Unless the official determines that the jersey is saturated with blood, B52 may remain in the game. (Note: Saturated is defined as soaked with moisture or drenched. If blood has penetrated through a garment to the skin or can be transferred to another player or game official, the garment is saturated.)
- IV. An official notices that blood has soaked through B10's jersey. **RULING:** B10 must leave the game until medical personnel have determined if the jersey must be replaced.

- V. B10 tackles A12. An official determines that B10's jersey is saturated with blood from a cut on A12's arm. **RULING:** Both players must leave the game—A12 for treatment of his open wound, B10 for a determination by medical personnel as to whether he has to replace his jersey.
- VI. During a dead-ball interval, A85 notices a bleeding cut on his arm. He voluntarily goes to the team area and is replaced by A88. **RULING:** This is a legal substitution and there is no variation in game timing. A85 may return to the game after the injury has been treated, but he must adhere to substitution rules.
- VII. On second down the Team A ball carrier is tackled inbounds. The clock is then stopped for an injury to a player of Team B. (a) No other players are injured on the play. (b) There is also an injury to a player of Team A. (c) The referee grants a media timeout. **RULING:** In (a), (b) and (c) upon preparing to resume play the referee will indicate that the play clock be set to 40 seconds. Both the play clock and the game clock will start on the ready-for-play signal.
- VIII. Late in the half ball carrier A35 is tackled. B79 goes to the ground with an injury and the officials stop the game clock, which shows (a) 12 seconds; (b) eight seconds. **RULING:** Team A has the option of a 10-second runoff. If there is no 10-second runoff the game clock starts on the snap. If Team A accepts the option, (a) there will be two seconds on the game clock which will start on the referee's signal; (b) time in the half has expired.
- IX. Late in the half ball carrier A35 is tackled beyond the line to gain. B79 goes to the ground with an injury. **RULING:** There is no option for a 10-second runoff because the game clock stops on the first down as well as the injury. The game clock starts on the referee's signal.

## Helmet Comes Off--Timeout—ARTICLE 9

### Approved Ruling 3-3-9

- I. After the ball is dead, A55 blocks B33 at his waist, knocking him to the ground. As B33 hits the ground his helmet comes off. **RULING:** Dead-ball foul by A55, 15-yard penalty from the succeeding spot. B33 must leave the game for the next down as his helmet came off through play and not due to a helmet foul. B33 may remain in the game if Team B takes a timeout.
- II. Late in the first quarter ball carrier A22 is legally tackled, and his helmet comes off just after his back hits the ground. The game clock reads 0:00. **RULING:** A22 must leave the game for the next down, which will be the initial down of the second quarter. A22's helmet came off through play and there was no helmet foul by Team B. However, A22 may remain in the game if Team A takes a timeout.
- III. During the down A22's helmet comes off (no helmet foul by the defense) and B77 goes down with an injury. The ball carrier is tackled inbounds. When the clock is stopped it reads 0:58 in the fourth quarter. **RULING:** Unless Team A takes a charged timeout, A22 must leave the game for one play. The play clock is set at 40 seconds, due to the defensive injury, rather than 25 seconds due to the helmet coming off the offensive player. There is no option for a 10-second runoff because the clock stops for both the helmet off and the injury, and these occur for opposing players.
- IV. During the down A22's helmet comes off (no helmet foul by the defense) and A45 goes down with an injury. The ball carrier is tackled inbounds. When



the clock is stopped it reads 0:58 in the fourth quarter. **RULING:** Because the injury and the helmet off occur to players on the same team, there is an option for a 10-second runoff. Team A may keep A22 in the game and also avoid the 10-second runoff by taking one charged timeout.

- V. During a play running play that ends in bounds, a linebacker's helmet comes off. When the ball becomes dead the game clock is stopped and reads 0:45 in the second quarter. **RULING:** The play clock is set at 40 seconds. Team A has the option for a 10-second runoff. If Team A exercises this option, unless Team B is charged with a timeout the game clock is set to 0:35 and starts on the Referee's signal. If Team B uses a timeout to avoid the 10-second runoff, the game clock remains at 0:45, the play clock is set at 25 and starts on the Referee's signal, and the game clock starts on the snap.

## Section 4. Delays

### Illegal Delay of the Game—ARTICLE 2

#### Approved Ruling 3-4-2

- I. After any timeout, one of the teams is not ready to play. **RULING:** Illegal delay. Penalty—Five yards from the succeeding spot.
- II. On a running play late in the half the Team A ball carrier is tackled inbounds. Team B players are deliberately slow to “unpile” in an obvious attempt to consume time and prevent the officials from making the ball ready for play. **RULING:** Team B foul for delay of game. Penalty—five yards for the succeeding spot. The game clock will start on the snap (Rule 3-4-3).

### Unfair Clock Tactics—ARTICLE 3

#### Approved Ruling 3-4-3

- I. In an attempt to consume time in the fourth period, Team A stalls and the play clock expires. **RULING:** Foul for delay of game. Penalty—Five yards from the succeeding spot. The clock starts on the snap.
- II. With two minutes remaining in either half and his team with no timeouts remaining, B77 crosses the neutral zone and touches a Team A player in an effort to conserve time. **RULING:** Dead-ball foul. Penalty—Five yards from the succeeding spot. The clock starts on the ready-for-play signal. At his discretion the referee may have the play clock set at 40 seconds. Note: If there is less than one minute remaining in the half, this foul comes under the 10-second runoff rule (Rule 3-4-4).
- III. A ball carrier, late in the second period, throws a backward pass out of bounds from behind or beyond the neutral zone to conserve time. **RULING:** Penalty—Five yards from the spot of the foul and loss of down. The clock starts on the ready-for-play signal. Note: If there is less than one minute remaining in the half, this foul comes under the 10-second runoff rule (Rule 3-4-4).
- IV. A ball carrier throws a forward pass while beyond the neutral zone to conserve time. **RULING:** Penalty—Five yards from the spot of the foul and loss of down. The clock starts on the ready-for-play signal (Rule 7-3-2 Penalty). Note: If there is less than one minute remaining in the half, this foul comes under the 10-second runoff rule (Rule 3-4-4).

- V. Late in the fourth quarter Team A trails by four points and is driving for a potential score. After a running play on which the ball carrier is tackled inbounds, Team B players are obviously and deliberately slow in letting him get to his feet or otherwise are employing tactics to delay the officials in making the ball ready for play. **RULING:** Dead-ball foul against Team B, delay of game. When the ball is ready for play, the referee will signal the 25-second clock to start, and the game clock will start on the snap.
- VI. Second and seven at the A-25. Team A is ahead in the score late in the second quarter. When ball carrier A22 is tackled in the field of play, the game clock reads 1:47. The umpire reports to the referee that he has a flag for holding by snapper A55. On the play, A22 gained (a) three yards; (b) nine yards. **RULING:** In both a) and b), after enforcement of the penalty, the game clock starts on the snap or on the referee's signal, at the option of Team B.

### 10-Second Runoff From Game Clock--Foul—ARTICLE 4

#### Approved Ruling 3-4-4

- I. Second and 10 at the B-30. The game clock is running in the second half. Team A trails by two points and is out of timeouts. After the ball is ready for play lineman A66 commits a false start, and when the officials stop the game clock it reads (a) 13 seconds; (b) 8 seconds. Team B accepts the yardage penalty and the clock runoff. **RULING:** (a) Five-yard penalty with 10 seconds subtracted from the game clock, which is set at 3 seconds. Second and 15 at the B-35. The clock starts on the referee's signal. (b) The game is over. Team B wins.
- II. Second and 10 at the B-30. The game clock is running in the second half. Team A trails by two points and is out of timeouts. At the snap Team A has five players in the backfield. A22 carries for a three-yard gain to the B-27. When the ball is declared dead the game clock reads (a) 13 seconds; (b) 8 seconds. **RULING:** (a) and (b) Five-yard penalty, illegal formation. Second and 15 at the B-35. Because the illegal formation is not a foul that causes the clock to stop immediately, the 10-second runoff does not apply. After the penalty is administered the game clock starts on the referee's signal.
- III. Team A is leading 24-21 with less than one minute in the game and the game clock running. With the ball ready for play on third and seven at the B-35, tackle B55 jumps across the neutral zone and contacts A77. The officials shut the play down with the game clock showing 0:38. Team B is out of timeouts. **RULING:** Offside against Team B. Five-yard penalty and a 10-second runoff from the game clock. The game clock is set at 0:28. Third and two at the B-30. The clock starts on the referee's signal.
- IV. Fourth quarter with the game clock running. Second and five at the B-20. Tackle B77 is in the neutral zone at the snap, but does not make contact. QB A12 rolls out to pass, runs to the B-17 and throws a forward pass, which falls incomplete. The game clock reads 0:15. **RULING:** Team A illegal forward pass and Team B offside. Offsetting fouls. No 10-second runoff. Second and 5 at the B-20. The game clock remains at 15 seconds and starts on the snap.
- V. Second and 10 at the B-30 with the game clock running. Team A trails in the score. Guard A66 in a three-point stance misses the snap count and lurches forward, committing a false start. B77 then commits a dead-ball personal foul or a dead-ball foul for unsportsmanlike conduct. The game clock is stopped

with 8 seconds remaining in the game. This occurs (a) in the fourth quarter; (b) in the second quarter. **RULING:** (a) The game is over because Team B will accept the 10-second runoff associated with the false start. Thus the penalty for B77's dead-ball foul is not enforced. (b) The half is over because Team B will accept the 10-second runoff associated with the false start. The penalty for the Team B dead-ball foul carries over to the second half. Due to the 10-second runoff, by interpretation the Team B dead-ball foul effectively occurs after the half has ended and the penalty is thus carried over. In either (a) or (b) Team A may avoid the 10-second runoff by using an available charged timeout. In that case the penalty for the foul by B77 would be enforced, giving Team A first and 10 at the B-20 after enforcement of both penalties.

- VI. Second quarter. At the snap the game clock reads 0:45. During the play, A55 loses his helmet. Right tackle A77 is flagged for holding. The ball carrier is tackled inbounds short of the line to gain. **RULING:** A55 must leave the game for one play. There is no option for a 10-second runoff, because at the end of the play the clock is stopped both for the helmet off and to administer the holding penalty. The play clock is set to 25 seconds and the game clock starts on the Referee's signal. (Rule 3-3-9)
- VII. 3/5 @ B-15 late in the fourth quarter, with Team A trailing 10-7. Quarterback A11 rolls out and is at the B-12 when he throws a forward pass that is incomplete. When the ball is dead the game clock shows 0:13. Team B accepts the penalty for the illegal forward pass. **RULING:** Fourth and seven at the B-17. Team B has the option for a 10-second runoff. Assuming that Team B accepts the runoff, the game clock is set at 0:03 and starts on the referee's signal.
- VIII. 2/7 @ A-5 late in the second quarter. Quarterback A11 drops back to pass and is scrambling in his end zone as he tries to find an open receiver. About to be tackled in the end zone, A11 throws the ball forward to the ground in an area where there are no eligible receivers. The referee throws a flag for intentional grounding. When the ball is dead the game clock shows 0:18. Team B accepts the penalty. **RULING:** The penalty results in a safety, and Team A will free kick at the A-20. Team B has the option for a 10-second runoff. If Team B accepts the runoff, the game clock is set at 0:08 and starts on the referee's signal. If Team B declines the runoff, the game clock remains at 0:18 and starts when the kicked ball is legally touched in the field of play.

## Section 5. Substitutions

### Legal Substitutions—ARTICLE 2

#### Approved Ruling 3-5-2

- I. Any player(s), in excess of 11, obviously is withdrawing but has not reached a boundary line when the ball is put in play and he does not interfere with play or players. **RULING:** Live-ball foul. Penalty—Five yards from the previous spot.
- II. After a change of team possession or any timeout, the ball is declared ready for play. When Team A has completed its offensive formation, Team B must promptly position its personnel. Team B will be allowed time to complete substitutions. **RULING:** Either team is subject to a delay-of-game foul—Team B for not completing its substitutions promptly (Rule 3-4-2-b-3) or

Team A for causing the 25-second clock to expire. Penalty—Five yards from the succeeding spot.

- III. On third down (no change of team possession), ball carrier A27 goes out of bounds or Team A's legal forward pass falls incomplete. During this interval between downs, there is no other referee's timeout. Before the fourth-down snap, substitute B75 enters the game and then departs without remaining in the game for one play. **RULING:** Dead-ball foul. Penalty—Five yards from the succeeding spot.
- IV. Team A has 11 players in the huddle. A81 mistakenly thinks he has been replaced and runs to his team area. He is immediately sent back onto the field and assumes a position on the line of scrimmage near his sideline. The entire team has been stationary for one second before the snap and there has not been a referee's timeout. **RULING:** Dead-ball foul. The player loses his status as a participant when he enters the team area while the ball is dead, and then must adhere to substitution rules. Penalty—Five yards from the succeeding spot, or 15 yards from the succeeding spot if this is judged to be a violation of Rule 9-2-2-b (Rules 3-5-2-d and 9-2-2-b).
- V. After the ball is ready for play and the umpire (or center judge) is in his regular position, Team A quickly replaces some players with substitutes, gets set for the required one second and snaps the ball. The umpire (or center judge) is attempting to get to the ball to allow the defense to match up, but he is unable to prevent the snap. **RULING:** The play is shut down, the game clock is stopped and the defense is allowed to substitute in response to Team A's late substitutions. No foul. The play clock is set to 25 seconds and starts on the ready-for-play signal. The game clock starts on the ready-for-play signal or the snap, depending on its condition when play was stopped. The referee informs the Team A head coach that any subsequent such actions will result in a foul against the team for unsportsmanlike conduct under Rule 9-2-3.
- VI. After a down that resulted in first and 10 at the B-40, eleven players of Team A, which runs a no-huddle offense, move to their various positions to set for the next play. The ball is ready for play when A22 runs onto the field from his team area, and after he pauses the top of the numbers, he or the coaching staff apparently realizes that he is the 12th player. A22 then turns and runs back to his team area. The ball has not been snapped. **RULING:** Dead-ball foul for a substitution infraction. By interpretation A22 has become a player by entering his team's "effective huddle" and thus must remain in the game for one play. Five-yard penalty. Team A will have first and 15 at the B-45. (Rule 2-27-9-b)
- VII. Late in the first half Team A is out of timeouts. A pass play on third down ends inbounds at the B-25 short of the line to gain with the game clock showing 0:10. Facing fourth down and three, Team A immediately hurries its field goal team onto the field. **RULING:** Team B should reasonably expect that Team A will attempt a field goal in this situation and should have its field-goal defense unit ready. The umpire will not stand over the ball, as there should be no issue of the defense being uncertain about the next play.
- VIII. Late in the first half Team A is out of timeouts. A pass play on third down ends inbounds at the B-25 short of the line to gain with the game clock showing 0:30. Facing fourth down and three, Team A gives no indication as to its next play until the game clock reads 0:10. They then rush their field goal unit onto the field, and Team B then hurries to respond. **RULING:**

The umpire moves to the ball to prevent the snap until Team B has had a reasonable opportunity to get its field-goal defense unit onto the field. The umpire will step away when he judges that the defense has had enough time. If the game clock reads 0:00 before the ball is snapped after the umpire steps away, the half is over.

### More Than Eleven Players on the Field—ARTICLE 3

#### Approved Ruling 3-5-3

- I. A33, an incoming substitute, enters the huddle or assumes a position in a formation and (a) after approximately two seconds, A34 leaves the huddle and departs the field of play at his sideline, or (b) after approximately four seconds, A34 leaves the huddle and departs the field of play at his sideline. **RULING:** (a) Legal. (b) Foul. (Note: A departing player who leaves the huddle or his position within three seconds is considered to have left immediately.)
- II. 3/5 @ B-35. Team B has 12 players in the formation, and no Team B player is attempting to leave the field while the ball is ready for play. Team A snaps the ball and the run by A44 gains 3 yards. **RULING:** Live ball foul, Team A 1/10 @ B-30.
- III. Team A has 11 players in its huddle when A27 approaches the huddle (within 10 yards) as it breaks. **RULING:** Dead-ball foul. Penalty—Five yards from the succeeding spot (Rule 2-27-9-a).
- IV. 3/5 @ B-35. Team B has 12 players in the formation, and B44 recognizes that he is the 12th player and is attempting to leave the field. When the ball is snapped, (a) B44 is on the field but his next stride takes him off the field; or (b) B44 touches out of bounds just before the snap. Team A snaps the ball and the run by A44 gains 3 yards. **RULING:** (a) Live ball foul by B44. Team A 1/10 @ B-30. (b) No foul by B44, 4/2 @ B-32. To not be counted as the 12th player, B44 must be off of the field of play.
- V. Team A is in formation to kick a field goal and Team B has 11 players in its formation. Just before the ball is snapped a 12th Team B player runs onto the field. The ball is snapped and the kicker completes his kick. **RULING:** Live-ball foul. Five-yard penalty, previous spot, or Team A may accept the result of the play.
- VI. Team A lines up for a two-point try attempt at the B-3. Team B has eleven players in its defensive formation. The 12th Team B player runs onto the field just before or just as the ball is snapped. A22 takes the handoff from the quarterback and (a) is tackled at the one-yard line; or (b) carries the ball into the end zone. **RULING:** Live-ball foul against Team B for illegal substitution. (a) Penalize Team B half the distance to the goal and repeat the try at the B-1.5. (b) Team A will decline the penalty on the successful try.
- VII. 3/5 @ B-35. Team B has 12 players in the formation, and no Team B player is attempting to leave the field. The ball is ready for play, both teams are in formation and the snap is imminent. Quarterback A12, late in the play clock, is struggling to read the defense and (a) calls timeout; or (b) the play clock expires. **RULING:** When the deep officials count 12 Team B players, both teams are in formation, no Team B player is attempting to leave the field and the snap is imminent, (a) the crew will offer Team A their time out back and penalize Team B for a substitution foul. Team A 1/10 @ B-30 (b) no foul for delay of game, penalize Team B for a substitution foul. Team A 1/10 @ B-30.

---

# RULE 4

## Ball in Play, Dead Ball, Out of Bounds

---

### Section 1. Ball in Play—Dead Ball

#### Live Ball Becomes Dead—ARTICLE 2

##### Approved Ruling 4-1-2

- I. Team A punts on fourth and 15 at the A-30. B44 is in position to receive the kick. In attempting to catch the ball, B44 muffs it at the B-35. The back judge blows his whistle when it appears that B44 is catching the ball, but it rolls along the ground after B44 muffs it. A88 chases the ball, and in the immediate continuing football action he recovers it while grounded at the B-30. B22 is flagged for holding during the kick. **RULING: For games without Instant Replay:** Inadvertent whistle. Rule 4-1-2-b-3 applies. The ball is returned to the previous spot and the 10-yard holding penalty is enforced. Team A retains possession and will have first and 10 at the A-40. **For games with Instant Replay:** Inadvertent whistle. Rule 12-3-3-1 applies. Team A declines the penalty and will have the ball at the B-30, first and 10.
- II. Team A punts on fourth and 15 at the A-30. B44 is in position to receive the kick. In attempting to catch the ball, B44 muffs it at the B-35. The back judge blows his whistle when it appears that B44 is catching the ball, but it rolls along the ground after B44 muffs it. The ball disappears into a pile of players. B22 is flagged for holding during the kick. **RULING: For games without Instant Replay:** Inadvertent whistle. Rule 4-1-2-b-3 applies. The ball is returned to the previous spot and the 10-yard holding penalty is enforced. Team A retains possession and will have first and 10 at the A-40. **For games with Instant Replay:** Inadvertent whistle. Rule 12-3-3-1 applies. Since the Instant Replay official does not have indisputable video evidence as to which team recovers, the ruling of the dead ball stands. The holding penalty is enforced at the B-35, under postscrimmage kick rules. Team B's ball, first and 10 at the B-25.
- III. First and 10 at the B-45. Ball carrier A22 is tackled and is going to the ground, when he fumbles. An official sounds his whistle inadvertently. Players on both teams go after the ball, and B66 clearly recovers it while grounded. **RULING: For games without Instant Replay:** Inadvertent whistle. Rule 4-1-2-b-2 applies. Team A will choose to repeat the down at the previous spot. **For games with Instant Replay:** Inadvertent whistle. Rule 12-3-3-d applies. If the replay official determines that A22 lost control of the ball before he was down, then the ball belongs to Team B at the spot of the recovery by B66. In the event that the replay official is not able to determine which team recovers the ball, the ruling that the ball carrier was

down before losing control of the ball stands, and Team A retains possession at the dead-ball spot.

- IV. Team A punts on fourth and 15 at the A-30. B44 is in position to receive the kick. In attempting to catch the ball, B44 muffs it at the B-35. The back judge blows his whistle when it appears that B44 is catching the ball, but it rolls along the ground after B44 muffs it. A88 chases the ball, and in the immediate continuing football action he recovers it while grounded at the B-30. **RULING: For games without Instant Replay:** Inadvertent whistle. Rule 4-1-2-b-3 applies. The ball is returned to the previous spot and the down repeated. Team A, fourth and 15 at the A-30. **For games with Instant Replay:** Inadvertent whistle. Rule 12-3-3-1 applies. Team A will have the ball at the B-30, first and 10.
- V. Team A punts on fourth and 15 at the A-30. B44 is in position to receive the kick. In attempting to catch the ball, B44 muffs it at the B-35. The back judge blows his whistle when it appears that B44 is catching the ball, but it rolls along the ground after B44 muffs it. The ball disappears into a pile of players. **RULING: For games without Instant Replay:** Inadvertent whistle. Rule 4-1-2-b-3 applies. The ball is returned to the previous spot and the down repeated. Team A, fourth and 15 at the A-30. **For games with Instant Replay:** Inadvertent whistle. Rule 12-3-3-1 applies. Since the Instant Replay official does not have indisputable video evidence as to which team recovers, the ruling of the dead ball stands. Team B's ball, first and 10 at the B-35.

### Ball Declared Dead—ARTICLE 3

#### Approved Ruling 4-1-3

- I. While A1 is holding the ball for a place kick, Team B plays the ball by (a) recovering a loose ball, (b) snatching it from A1 or (c) batting it from his hands. **RULING:** (a), (b) and (c) The ball remains alive. In (c) the batting by Team B is legal and results in a fumble.
- II. Team A is in formation to attempt a field goal. At the snap A22 is in position to execute a right-footed place kick and A33 is in position as the holder. The snap goes to A33 who has a knee on the ground. Just after the snap A22 breaks to his left and toward the neutral zone, and A33, while still on his knee, flips a forward pass to A22 who carries the ball beyond the line to gain before he is tackled. **RULING:** Legal play, because at the snap A22 was in position to attempt a place kick. First and 10 for Team A.
- III. 3/10 @ A-35. Quarterback A11 sweeps to his right and goes into a feet-first slide to give himself up. When he starts his slide, the forward-most point of the ball is at the A-44, and when he comes to a stop the forward-most point of the ball is at the A-46. **RULING:** Fourth and one at the A-44. The ball is dead at its forward-most point when he starts his slide.
- IV. 3/10 @ B-40. QB A12 takes the snap and rolls out to the right. Finding no receiver open, A12 turns up field and runs. After making the line to gain, A12 breaks stride as if he is going to slide feet first at the B-27, stays upright and runs for a touchdown. **RULING:** The live ball becomes dead at the point where A12 simulates or fakes as if he will begin a feet-first slide. An official shall sound their whistle and declare the ball dead. Team A will have 1/10 @ B-27. A fake slide is not reviewable under Rule 12-3-3.



## Ball Ready for Play—ARTICLE 4

### Approved Ruling 4-1-4

- I. Snapper A1 snaps the ball before the ball is made ready for play. A2 muffs the snap and B1 recovers the ball. **RULING:** Dead-ball foul, Team A delay of game. Penalty—Five yards from the succeeding spot, Team A's ball. The ball does not become alive, and all action should be stopped immediately by the game officials.
- II. Kicker A1 kicks off before the referee has declared the ball ready for play. **RULING:** Dead-ball foul. Penalty—Five yards from the succeeding spot. The ball does not become alive, and all action should be stopped immediately by the game officials.

## Section 2. Out of Bounds

### Player Out of Bounds—ARTICLE 1

#### Approved Ruling 4-2-1

- I. An inbounds ball carrier bumps into or is touched by a player or game official on the sideline. **RULING:** The ball carrier is not out of bounds.
- II. Ball carrier A1 is running inbounds near the sideline when he is contacted by a squad member of Team B, who is on the sideline. **RULING:** Rule 4-2-1 states a player is out of bounds when any part of his person touches anything other than a player or an official. Penalty—15 yards or other unfair-action game administration-interference penalties (Rules 9-2-3 and 9-2-5).
- III. Team A executes an on-side kick at the A-35. A33 is running near the sideline and steps out of bounds at the A-45. At the A-47 he leaps and bats the ball forward, and it rolls out of bounds at the A-49. **RULING:** Foul against Team A for free kick out of bounds at the A-47. Airborne A33 is out of bounds when he touches the ball because he has not established himself in bounds after going out of bounds. Not a foul for batting the ball forward because the ball is dead as soon as A33 touches it (Rule 4-2-3-a).

### Loose Ball Out of Bounds—ARTICLE 3

#### Approved Ruling 4-2-3

- I. A88 is airborne and secures firm control of A12's forward pass. A88's right foot lands inbounds and he maintains firm control of the ball as he contacts the ground. B28, who is standing out of bounds, has his hand touching the ball while A88 is airborne and in firm control of the ball. **RULING:** Completed forward pass.

### Out of Bounds at Forward Point—ARTICLE 4

#### Approved Ruling 4-2-4

- I. A player with one foot out of bounds behind a goal line touches a loose ball in the field of play. **RULING:** Ball is out of bounds and dead at its most forward point in the field of play. If this loose ball was an untouched free kick, it is a free kick out of bounds and a foul. Penalty—Five yards from the previous spot or Team B's ball 30 yards beyond Team A's free-kick line.



---

# RULE 5

## Series of Downs, Line to Gain

---

### Section 1. A Series: Started, Broken, Renewed

#### Forward Progress—ARTICLE 3

##### Approved Ruling 5-1-3

- I. Airborne A88 gains firm control of a legal forward pass one yard within the opponent's end zone. As A88 gains firm control the ball (a) he is contacted by B21 and A88 first comes to the ground on his knees at the one-yard line and maintains firm control of the ball; (b) A88 is contacted by B21 and A88 first comes to the ground on his feet at the one-yard line and maintains firm control of the ball. **RULING:** Touchdown in both (a) and (b) (Rule 5-1-3-a Exception 2, 8-2-1-b).
- II. Receiver A88 runs a route deep into Team B's end zone and circles back toward the QB A12 who throws the ball to A88. As A88 is coming back toward A12, A88 leaps and gains firm control of A12's legal forward pass one yard within Team B's end zone. Airborne A88 is not touched by a Team B player and first comes to the ground maintaining firm control of the ball at the one-yard line landing (a) on his knees; (b) on his feet. After A88 regains his balance, A88 runs and is downed at Team B's five-yard line. **RULING:** Not a touchdown: (a) Team A's ball at the B-1 where the ball is declared dead. (b) Team A's ball at the B-5 where the ball is declared dead.
- III. Airborne A2 receives a legal forward pass at Team A's 35-yard line. As A2 receives the ball, he is contacted by B1 and first comes to the ground with the ball at Team A's 33-yard line, where the ball is declared dead. **RULING:** Team A's ball at the 35-yard line. This is the point of forward progress.
- IV. A4, with the ball breaking the plane of the 50-yard line while in his possession, dives over the 50-yard line, which is the line to gain for a first down. He is knocked back to Team A's 49-yard line, where any part of his body except his hand or foot touches the ground. **RULING:** First down at forward progress spot (Rule 4-1-3-b).
- V. A6 has the ball in his possession and is not controlled by an opponent, as he dives over the 50-yard line, which is the line to gain for a first down, and is forced back across the 50-yard line. A6 continues to run and is tackled at Team A's 49-yard line, where any part of his body except his hand or foot strikes the ground. **RULING:** No first down. The point of forward progress is Team A's 49-yard line.

- VI. A5, with the ball breaking the plane of the goal line while in his possession, dives over the goal line and is knocked back to the one-yard line, where any part of A5's body except his hand or foot touches the ground. **RULING:** Touchdown. The ball is dead when it breaks the plane of the goal line in A5's possession.

## Section 2. Down and Possession After a Penalty

### Foul Before Change of Team Possession—ARTICLE 3

#### Approved Ruling 5-2-3

- I. Team A's fourth-down legal forward pass strikes the ground after it touches an originally ineligible receiver who is illegally more than three yards beyond the neutral zone. **RULING:** Foul, ineligible receiver downfield. Penalty—Five yards from the previous spot. Team B's ball, first and 10, if the penalty is declined (Rule 7-3-10).

### Foul Between Downs—ARTICLE 6

#### Approved Ruling 5-2-6

- I. Fourth and two on Team A's 35-yard line. A1 takes the snap and fumbles the ball on Team A's 38-yard line, with the ball going out of bounds on (a) Team A's 40-yard line or (b) Team A's 30-yard line. Immediately after the ball goes out of bounds, Team A commits a personal foul. **RULING:** (a) Team A's ball, first and 10 on Team A's 23-yard line. Start the clock on the ready-for-play signal. (b) Team B's ball, first and 10 on Team A's 15-yard line. Start the clock on the snap.

### Foul Between Series—ARTICLE 7

#### Approved Ruling 5-2-7

- I. Third and four on Team B's 30-yard line. Ball carrier A22 goes out of bounds on the 18-yard line. B88 commits a foul immediately after the ball is out of bounds. **RULING:** First and goal for Team A at the nine-yard line. Clock starts on the ready-for-play signal except in the last two minutes of a half.
- II. Fourth and four at the A-16. Ball carrier A22 goes out of bounds at the A-18. A77 commits a foul immediately after the ball is out of bounds. **RULING:** Team B's ball on the nine-yard line. First and goal. Start the clock on the snap.
- III. On fourth and five, Team A gains six yards and is awarded a new series. After the ball is made ready for play and before the snap, A55 commits (a) a personal foul or (b) a false start. **RULING:** (a) First and 25. (b) First and 15.
- IV. Team A's ball, third and four from the 50-yard line. After the ball is made ready for play and before the snap, B60 charges across the neutral zone and contacts snapper A50. A61 then fouls B60. A61's foul is a personal foul. **RULING:** Penalize Team B five yards for B60's offside, then penalize Team A 15 yards and reset the line-to-gain indicator to indicate first and 10 from Team A's 40-yard line.

- V. After Team A has made a first down, the umpire has placed the ball on the ground at the B-30. The referee waves the umpire away from the ball but before he signals the ball ready for play, snapper A55 snaps the ball. **RULING:** Team A dead-ball foul for delay of game. Five-yard penalty, first and 10 at the B-35. **NOTE:** This is a foul between series in that it takes place before the ball is declared ready for the next series. Hence it is first and 10, not first and 15. (Rules 4-1-1, 4-1-4)
- VI. Ball carrier A22 is tackled hard by B44 at the B-5, resulting in first and goal. After the ball is dead, A22 gets up and punches B44. **RULING:** 15-yard penalty against Team A; A22 is ejected. After enforcement of the penalty, Team A will have first and 10 at the B-20.

---

# RULE 6

## Kicks

---

### Section 1. Free Kicks

#### Free-Kick Formation—ARTICLE 2

##### Approved Ruling 6-1-2

- I. The ball is kicked while teed illegally, punted on a kickoff or kicked from a spot between the hash mark and the nearer sideline. **RULING:** Illegal kick. Dead-ball foul. Penalty—Five yards from the succeeding spot (Rule 2-16-1-b).
- II. Kicker A11 places the ball on the tee in the center of the field for a free kick with four teammates to the left side of the ball and six teammates to the right side of the ball. The ball blows off the tee. A55, who was lined up to the left of the ball, then holds the ball on the tee for right-footed kicker A11. No other Team A players move. When the ball is kicked by A11, A55 is to the kicker's right. **RULING:** Foul by Team A for illegal formation at the kick. Penalty—Five yards from the previous spot or five yards from the spot where the subsequent dead ball belongs to Team B.
- III. Free-kicker A11 places the ball on the tee just inside the hash mark line on his right. All of his teammates line up to his left. At the ready for play, four Team A players who were on A11's left run to their right and are in the area to A11's right when he kicks the ball. **RULING:** Legal formation.
- IV. A11 places the ball on the tee for a free kick on the 35-yard line in the center of the field. A12 lines up near the ball. After the ready for play, A11 starts forward as if to kick the ball, and A12 suddenly crosses in front of him and kicks the ball. When the ball is kicked, A11 is directly behind the ball with three teammates on one side of the ball. A12 plants his nonkicking foot on the same side of the ball as his three teammates. **RULING:** Foul by Team A for illegal formation. Penalty—Five yards from the previous spot, and rekick if Team B chooses; or five yards from the spot where the subsequent dead ball belongs to Team B.
- V. Team A is offside during its free kick. B27 has his knee on the ground when he recovers the kick. **RULING:** Foul by Team A for offside. The ball is dead at the spot of the recovery. Penalty—Team B may choose five yards from the previous spot and another free kick, or five yards from the dead-ball spot with a first and 10. B27's recovery started a running play that ended immediately. This scenario also would have been valid if B27 had completed a fair catch.
- VI. Team A is offside on its free kick and B17 catches the ball at his 15-yard line. B17 returns the ball to his 45-yard line where he fumbles. A67 recovers at the B-47 and runs to the B-35 where he fumbles, with B20

recovering while downed at his 33-yard line. **RULING:** Foul by Team A for offside. Team B may choose to have Team A kick again after a five-yard penalty from the previous spot, or Team B may have first and 10 at its 38-yard line.

- VII. Team A is in its formation to kick off at the A-35. Two players, A33 and A66, are positioned in a four-point stance with their feet on the A-29 and their hands on the A-31. The untouched kick hits the ground in Team B's end zone and is declared dead. **RULING:** Touchback. Team A foul, illegal formation. Team B has two options for accepting the penalty: Put the ball in play at the B-30, after a five-yard penalty at the spot (the B-25) where the dead ball belongs to them; or have Team A re-kick at the A-30. (Rule 6-1-8)
- VIII. Late in the game with the score tied, Team A lines up to free kick from the A-35. Kicker A10 places the ball down at the right hash for an apparent outside kick. After the Referee's ready-for-play signal, A10 approaches the ball and then picks up the ball runs to the left hash at the A-35, places the ball down and quickly kicks the ball. **RULING:** By interpretation, once the ball position between the hash marks has been selected by Team A and after the ready-for-play, the ball may be relocated only after a charged team timeout or before any re-kick. Dead-ball foul. Five yard penalty from the previous spot.

### Free-Kick Recovery—ARTICLE 3

#### Approved Ruling 6-1-3

- I. A33 illegally touches a free kick; then he or A44 illegally recovers the kick. **RULING:** Illegal touching by both A33 and A44. Unless there is an accepted penalty or offsetting fouls, Team B may elect to take the ball at any spot of the illegal touching.
- II. Team A executes an on-side free kick at the A-35. The untouched kick is at the A-43 when A55 blocks B44 above the waist in the front at the A-46. A28 muffs the ball at the A-44, and after it rolls to the A-46, A88 blocks B22 at the A-42. A20 then recovers the ball at the A-44. **RULING:** The block by A55 is a foul and the touching by A28 is illegal, because Team A is not eligible to touch the ball since it has not gone 10 yards nor has it been touched by Team B. The block by A88 is legal because it occurs after the ball has gone 10 yards. Team A is in legal possession of the ball when A20 recovers it at the A-44. Team B has two options: Decline the penalty for the illegal block and have the ball at the A-44 via the illegal-touching privilege, or cancel the illegal-touching privilege by having Team A re-kick from the A-30 after the 5-yard penalty for the block by A55. Note that the dead-ball spot, the A-44, is not an enforcement spot because the ball does not belong to Team B when the down ends. (Rule 6-1-12)

## Section 2. Free Kick Out of Bounds

### Kicking Team—ARTICLE 1

#### Approved Ruling 6-2-1

- I. A kickoff from Team A's 35-yard line goes out of bounds untouched by Team B, and Team A has illegally touched the kick. **RULING:** Team B

has four options: It may snap the ball at the spot of the illegal touching violation; accept a five-yard penalty from the previous spot with Team A kicking from the 30-yard line; put the ball in play at the inbounds spot on its 35-yard line; or put the ball in play at the inbounds spot five yards from where the ball went out of bounds (Rule 6-1-8).

- II. Team A is offside or commits a substitution infraction, and the kickoff from the 35-yard line goes out of bounds after it has been touched by Team B. **RULING:** For either the offside foul or the substitution foul, Team B may elect to have the kick repeated at Team A's 30-yard line, or snap the ball at the inbounds spot five yards from where the ball went out of bounds (Rule 6-1-8).

## Receiving Team—ARTICLE 2

### Approved Ruling 6-2-2

- I. A free kick from Team A's 35-yard line, untouched by Team B, goes out of bounds between the goal lines, and Team A was offside. **RULING:** Team B has these options: It may accept a five-yard penalty at the previous spot with Team A re-kicking from the 30-yard line; snap the ball at its 35-yard line at the inbounds spot; or snap the ball at the inbounds spot five yards from where the ball went out of bounds.
- II. A free kick from Team A's 35-yard line, untouched by Team B, goes out of bounds between the goal lines, and Team A fouled after the ball went out of bounds. **RULING:** Team B has the choice of Team A kicking again after a five-yard penalty followed by a 15-yard penalty, or putting the ball in play at the inbounds spot either on the 50-yard line or at the inbounds spot 20 yards beyond the spot where the ball went out of bounds.
- III. A free kick in flight strikes a Team B player who is in his end zone, and the ball then goes out of bounds at the three-yard line. **RULING:** Team B's ball, first and 10, on the three-yard line at the inbounds spot.
- IV. Free kick at the A-35. B17 leaps from inbounds and is the first player to touch Team A's free kick when he grasps the ball while airborne. He then lands out of bounds with the ball in his control. **RULING:** Not a foul for free kick out of bounds. B17 is inbounds when he touches the kick. Team B will have the ball at the yard line where B17 crossed the sideline. (Rule 2-27-15)

## Section 3. Scrimmage Kicks

### Behind the Neutral Zone—ARTICLE 1

#### Approved Ruling 6-3-1

- I. After a punt travels five yards beyond the neutral zone, B33 touches the ball. It then rebounds behind the zone, where A33 recovers it in the field of play. **RULING:** The ball is dead when recovered and may not be advanced. First down for Team A (Rules 6-3-3 and 6-3-6-a). Clock starts on the snap following a legal kick down.
- II. Team A's untouched punt or field goal attempt goes beyond the neutral zone in flight, is blown back by the wind and first touches the ground, a player or an official behind the neutral zone. **RULING:** By rule, the kick is not considered to have crossed the neutral zone until it has touched the

ground, a player, an official or anything beyond that zone. Any scrimmage kick may be advanced after catch or recovery by Team B, or after catch or recovery by Team A in or behind the neutral zone if the kick had not crossed the neutral zone (Rule 2-16-7).

- III. A1 interferes with B1's opportunity to catch a kick when a scrimmage kick fails to cross the neutral zone. **RULING:** Interference with the opportunity to catch a kick does not apply (Rule 6-4-1), and all players are eligible to touch, recover and advance the ball. Therefore, any player legally may push an opponent in an actual attempt to get at the ball (Rule 9-3-6); but no player may hold an opponent to prevent his reaching the ball or in an attempt to permit a teammate to reach it (Rules 9-1-5 Exception 3).
- IV. Team A's punt from behind its own goal line crosses the neutral zone into the field of play, strikes a Team B player and rebounds back across Team A's goal line, where A32 recovers. **RULING:** Safety (Rules 6-3-3, 6-3-6-a and 8-5-1-a).

## **Beyond the Neutral Zone—ARTICLE 2**

### **Approved Ruling 6-3-2**

- I. Team A illegally touches its kick; then after Team B has touched it, Team A recovers. **RULING:** Touching by Team A after Team B has touched the kick is legal; and, in order to get the ball, Team B must take it where Team A illegally touched it. Unless illegal touching is also illegal recovery by the kicking team and no fouls are involved, the receiving team may play the ball with the assurance that it later may elect the ball at any spot of illegal touching.
- II. During a scrimmage kick, A1 commits a touching violation, after which B1 recovers, advances and fumbles. A2 recovers the fumble and, during the advance, B2 holds, trips or punches. **RULING:** Team A may have the ball where left by the penalty for Team B's foul; but if Team A declines the penalty, Team B will have the ball by electing the touching violation. B2 is ejected if flagged for fighting.
- III. Team A's punt goes beyond the neutral zone and is first touched by A80, then picked up by B40, who runs five yards and fumbles. A20 picks up the fumble and scores. During A20's run, B70 holds. **RULING:** The score does not count. Five- and 10-yard penalties are not administered on the try or the succeeding kickoff. The penalty for Team B's foul is declined by rule, because there is no enforcement spot. The ball belongs to Team B at the spot of illegal touching (Rule 10-2-5-a-2).
- IV. Team A's punt goes beyond the neutral zone and is first touched by A80, then picked up by B40, who runs five yards and fumbles. B70 holds during B40's run. A20 picks up the fumble and scores. **RULING:** The score does not count. Five- and 10-yard penalties are not administered on the try or the succeeding kickoff. Because the illegal touching provides an enforcement spot, the penalty for Team B's foul may be enforced, per Rule 5-2-4. The ball belongs to Team B, either at the spot of illegal touching if Team A declines the penalty, or at the spot after the enforcement if Team A accepts the penalty (Rules 10-2-2 and 10-2-5-a-2).

## Forced Touching Disregarded—ARTICLE 4

### Approved Ruling 6-3-4

- I. Team A punts from its own 30-yard line. The untouched kick is bouncing at Team B's three-yard line when A3 blocks B1 into the ball, forcing it through the end zone and over the end line. **RULING:** Touchback. Since A3 blocked B1 into the ball, B1 is deemed not to have touched it (Rule 2-11-4). Impetus is from the kick, not from B1's touching (Rule 8-7-1).
- II. Team A's long field goal attempt is first touched when A1 bats the rolling ball backward into nearby B1. **RULING:** Illegal touching by A1. Team B is not deemed to have touched the ball (Rules 2-11-4 and 8-4-2-b).
- III. During a scrimmage kick the untouched ball is at rest on the Team B three-yard line when B22 blocks A80 into the ball, forcing it into the end zone where it touches the ground. **RULING:** The ball is dead when it touches the ground in the end zone. Touchback—Ignore touching by A80 (Rule 2-11-4). By rule, neither team has touched the kicked ball (Rule 8-6-1-b).
- IV. As the punted ball rolls along the ground, punt receiver B22 is blocking A88 to prevent him from downing the ball. The two players are still engaged when the ball bounces into B22's leg. A44 recovers at the B-30. **RULING:** Team A's ball, first and 10 at the B-30. This is not forced touching. Although B22 was in contact with A88 when he touched the ball, this touching was not caused by the contact (Rule 2-11-4). The game clock starts on the snap.
- V. As a punt rolls along the ground A44 blocks B33 into the ball, which bounces away and strikes B48 in the leg. Team A recovers. **RULING:** Team A's ball, first and 10 at the spot of recovery. Although the touching by B33 is forced, that by B48 is not (Rule 2-11-4). B48's touching of the ball allows Team A to recover legally. (Rule 6-3-4-a)

## Touching Ground On or Behind Goal Line—ARTICLE 9

### Approved Ruling 6-3-9

- I. A33 illegally touches a punt and the ball then rolls into Team B's end zone, where Team B recovers and advances the ball into the field of play. **RULING:** The ball is dead when it strikes the ground in the end zone. Team B may choose a touchback or take the ball at the spot of Team A's illegal touching (Rule 4-1-3-c).
- II. A punt goes into Team B's end zone untouched by Team B beyond the neutral zone. Team B commits a personal foul after the ball touches the ground in the end zone. **RULING:** Touchback. Dead-ball foul after the touchback. Team B's ball, first and 10 on the 10-yard line after enforcement of the penalty at Team B's 20.
- III. A Team B player touches a scrimmage kick in flight in Team B's end zone, and Team A downs the ball in the end zone. **RULING:** Team A touchdown (Rules 6-3-3 and 8-2-1-d).

## Loose Behind the Goal Line—ARTICLE 11

### Approved Ruling 6-3-11

- I. Team A snaps at the 50-yard line and punts. The kick is untouched beyond the neutral zone when A88 reaches across Team B's goal line and bats



the ball back into the field of play, and it rolls out of bounds at the B-4. **RULING:** No foul for batting the ball in the end zone. Illegal touching. The spot of the violation is the B-20. Team B's ball, first and 10 at the B-20.

- II. Team A snaps at the 50-yard line and punts. The kick is untouched beyond the neutral zone when A88 reaches across Team B's goal line and bats the ball back into the field of play. B22 recovers at the B-2 and advances to the B-12 where A66 tackles him by pulling his facemask. **RULING:** No foul for batting in the end zone. Illegal touching. Team B may accept the penalty for the facemask foul, which cancels the illegal touching privilege, and have first and 10 at the B-27.
- III. Team A snaps at the 50-yard line and punts. The kick is untouched beyond the neutral zone when A88 reaches across Team B's goal line and bats the ball back into the field of play. B22 muffs the ball at the B-2 and A43 recovers it at the B-6. While the ball is loose B77 holds A21 at the B-10. **RULING:** Team A may cancel the illegal touching privilege by accepting the holding penalty, which is enforced at the previous spot with an automatic first down. Postscrimmage kick rules do not apply to B77's foul since Team B will not next put the ball in play (Rule 10-2-3).
- IV. Team A snaps at the 50-yard line and punts. During the kick, B77 clips at Team B's 25-yard line. The untouched kick is batted backward by Team A out of bounds from the end zone and goes out of bounds on the two-yard line. **RULING:** No foul for batting the ball in the end zone. Illegal touching. B77's clipping foul is governed by postscrimmage kick rules (Rule 10-2-3). Team A will accept the penalty, which cancels the illegal touching privilege. The penalty is enforced at the postscrimmage kick spot, the B-20, half the distance to the goal. Team B's ball at the B-10.
- V. Team A snaps at the 50-yard line and punts. The kick is untouched beyond the neutral zone when A88 reaches across Team B's goal line and bats the ball back into the field of play, and it rolls out of bounds at the B-4. During the kick, A55 blocks below the waist. **RULING:** No foul for batting the ball in the end zone. Illegal touching. The spot of the violation is the B-20. Team B may accept the penalty for blocking below the waist, which is enforced either at the previous spot with the down repeated or at the B-4. If Team B declines the penalty, the illegal touching gives the ball to Team B, first and 10 at the B-20.

## **Out-Of-Bounds Player—ARTICLE 12**

### **Approved Ruling 6-3-12**

- I. Gunner A88 is running near the sideline to cover a punt when he steps on the sideline and then returns inbounds to continue down the field. He tackles the kick returner at the B-30. **RULING:** Foul by A88 for returning inbounds during the scrimmage kick play. 5-yard penalty. Team B may have the down repeated after the penalty or put the ball in play at the B-35.

## **Fouls by Kicking Team—ARTICLE 13**

### **Approved Ruling 6-3-13**

- I. Team A punts on fourth and seven at the A-35. At the snap Team A has five players in the backfield. The kick is partially blocked and goes out

- of bounds at the A-45. **RULING:** Foul for illegal formation. Team B may have the ball, first and 10 at the A-40 after the five-yard penalty is enforced at the A-45 (the dead-ball spot) or have the penalty enforced at the previous spot with fourth down repeated at the A-30.
- II. Team A punts on fourth and seven at the A-35. At the snap Team A has five players in the backfield. The kick is partially blocked, does not cross the neutral zone and is returned by B88 to the A-28 where he is tackled. **RULING:** Team B may decline the penalty and have the ball at the A-28 or have the penalty enforced at the previous spot with fourth down repeated at the A-30.
- III. Team A punts on fourth and seven at the A-35. At the snap Team A has five players in the backfield. The kick is partially blocked, crosses the neutral zone, goes back behind the neutral zone and rolls out of bounds at the A-32. **RULING:** Team B may have the ball, first and 10 at the A-27 after the five-yard penalty is enforced at the A-32 (the dead-ball spot) or have the penalty enforced at the previous spot with fourth down repeated at the A-30.
- IV. Fourth and 15 at the A-5. Punter A88 from Team A's end zone kicks the ball. Tackle A77 is flagged for holding in the end zone. Team B returns the ball to the B-45. **RULING:** Team B has the option of having possession after the penalty is enforced at the B-45 or accepting the penalty for a safety. (Rule 10-2-4)

## Defensive Linemen on Scrimmage Kicks—ARTICLE 14

### Approved Ruling 6-3-14

- I. 4/3 @ B-25. Team A is in a formation to attempt a field goal. B50 lines up within one yard of the line of scrimmage and in the gap between the snapper and the guard. B50's shoulder overlaps with the snapper's shoulder. The field goal attempt is good. **RULING:** Live ball foul by B50. Team A may keep the 3 points and decline the penalty or accept the penalty, no score and have 1/10 @ B-20.
- II. 4/6 @ A-24. Team A is in scrimmage kick formation and punts. B50 is lined up inside the frame of the snapper and is within one yard of the line of scrimmage. The punt rolls out of bounds at the B-40. **RULING:** Live ball foul by B50. Team A may accept the penalty and have 4/1 @ A-29 or decline the penalty and it will be Team B's ball, 1/10 @ B-40.
- III. Fourth and 7 at the B-20. Team A is in a formation to attempt a field goal. Defensive linemen B55, B57, and B78 are shoulder to shoulder. B57 is head up on right guard A66 while B55 and B78 are in the gaps on A66's left and right shoulders, respectively. After the ball is snapped all three move forward together. (a) The three make their primary contact against A66; (b) B55 and B57 contact A66, and B78 drives at the right offensive tackle; (c) B57 and B78 make their blocks against A66 but B55 leaps to try to block the kick. **RULING:** (a) Foul. Five-yard penalty. If Team A accepts the penalty they will have fourth and two at the B-15. (b) and (c) No foul. The action by the Team B players does not involve primary contact against a single player, and hence the play is legal.
- IV. Fourth and four at the B-20. Team A is in a formation to attempt a field goal. Team A has five players in the backfield. Defensive linemen B55, B57, and B78 are shoulder to shoulder. B57 is head up on right

guard A66 while B55 and B78 are in the gaps on A66's left and right shoulders, respectively. After the ball is snapped all three move forward together. The three make their primary contact against A66. The holder takes the snap, gets to his feet, and completes a pass to eligible A88 who is tackled at the B-10. **RULING:** Foul by Team A, illegal formation. Foul by Team B, triple team against an offensive lineman. The fouls offset and the down is repeated.

## Section 4. Opportunity to Catch a Kick

### Interference With Opportunity—ARTICLE 1

#### Approved Ruling 6-4-1

- I. A Team A player catches a free kick very near receiver B25, thus preventing him from making the catch. **RULING:** Kick-catch interference. Penalty—15 yards from the spot of the foul.
- II. A Team B player, about to catch a scrimmage kick, is tackled before the ball arrives but catches the kick while he is falling. **RULING:** Kick-catch interference. Penalty—15 yards from the spot of the foul. Ejection of the Team A player if the contact is flagrant. If the foul is between the goal lines, enforcement is from the spot of the foul and Team B puts the ball in play by a snap; if behind Team B's goal line, award a touchback and penalize from the succeeding spot. The ruling would be the same had the kick been muffed or fumbled. The ruling also applies on an unsuccessful field goal attempt since Team B touched the ball beyond the neutral zone.
- III. While a kick is in flight beyond the neutral zone, A1 is standing or running between the ball and B1. (a) The ball strikes A1 while B1 is in a position to catch the ball. (b) B1, in attempting to catch the ball, bumps into A1. **RULING:** (a) and (b) Kick-catch interference. Penalty—15 yards at the spot of the foul.
- IV. A player of Team B, attempting to catch a kick (no fair catch signal), muffs the ball which is then touched by an opponent who was not interfering with the opportunity of the receiver when he was in position to make the catch. **RULING:** Not interference. In the absence of a fair catch signal, protection against interference with the opportunity to catch a kick ends when any player of Team B muffs the ball.
- V. A Team A player beyond the neutral zone first touches or catches a scrimmage kick that no receiver could have caught while it was in flight. **RULING:** Illegal touching but not interference.
- VI. B25 is standing at the B-35 in position to catch a punt. As the ball is on its downward flight A88 runs by B25 very close to his side, causing B25 to adjust his position before catching the ball. A88 does not make contact and does not penetrate the one-yard area directly in front of B25. **RULING:** Foul by A88, interference with the opportunity to catch the kick. 15 yards, spot of the foul. Even though B25 catches the ball, A88's action causes him to move away from his original location and thus interferes with his opportunity to make the catch.
- VII. B10 signals for a fair catch, muffs the ball and then catches it. **RULING:** If B10 has an opportunity to catch the kick after the muff, he must be

given an unimpeded opportunity to complete the catch. If B10 catches the muffed kick, the ball is dead where he first touched it.

- VIII. Fourth and 10 at the 50-yard line. B17 is at Team B's 20-yard line and in position to catch Team A's high scrimmage kick. During the downward flight of the ball, A37 contacts B17 viciously and flagrantly before he touches the ball. A37 did not alter his speed or make any attempt to elude B17. **RULING:** Team A flagrant personal foul, interference with the opportunity to catch a kick. Penalty—15 yards from the spot of the foul. A37 is ejected.
- IX. Team A's ball, fourth and 10 at the 50-yard line. Team A's windblown scrimmage kick is on its downward flight at Team B's 30-yard line. B18, starting at the 20-yard line, must detour around A92 at the 25-yard line to make the catch at the 30-yard line. **RULING:** Foul by A92 for interference with the opportunity to catch a kick. Penalty—15 yards from the spot of the foul, which is the 25-yard line.
- X. Punt receiver B44 is standing at his 30-yard line in position to catch the kick. Defender A11 races down the field to cover the punt and reaches a point about a foot directly in front of B44 as the ball descends. B44 makes the catch without having to adjust his position or manner of catching the ball because of the presence of A11, who does not pull back to give B44 more room. **RULING:** Foul for kick-catch interference. A11 entered the one-yard area directly in front of receiver B44. 15-yard penalty.
- XI. Punt receiver B22 is at the B-30 awaiting the punt as it makes its downward flight and his teammate B88 is three yards in front of him at the B-33. Down field to cover the kick, A44 legally blocks B88 into B22 just as the ball reaches him. The ball hits B22 in the shoulder and bounces away. Team A recovers at the B-25. **RULING:** Team A's ball, first and 10 at the B-25. This is not kick-catch interference. The action by A44 is against B88 who is not in position to catch the kick, and not against B22. Thus A44 is not deemed to have interfered with B22's opportunity to catch the ball. B22's touching of the ball allows Team A to recover legally.
- XII. Fourth and five at the A-30. Punt receiver B22 is in position to catch the kick at the B-30. He does not signal. A88 is within a yard of B22, at his side, but does not make contact with B22 when he catches the kick at the B-30. B22 is tackled at the B-32. A88's presence does not cause B22 to make any adjustment to his position or his manner of catching the ball. **RULING:** Legal play; no kick-catch interference. A88 is closer than one yard to B22 but is not directly in front of him. He does not affect B22's opportunity to catch the ball. First and 10 for Team B at the B-32.
- XIII. B44 is in position to catch a punt at the B-25. While the ball is still very high in the air and well before it comes close to B44, A88 runs directly in front of B44 within a yard but is not near him when the ball arrives. B44 catches the punt and is tackled. **RULING:** No foul. Although A88 penetrates the one-yard region directly in front of the receiver, this is so early in the action that there is no interference with B44's opportunity to catch the kick.

## Section 5. Fair Catch

### Dead Where Caught—ARTICLE 1

#### Approved Ruling 6-5-1

- I. After a valid or invalid signal, B1 muffs the punt and B2, who did not signal, catches the kick. **RULING:** The ball is dead when B2 catches it and the ball is placed where B1 first touched it.
- II. B1 has a foot out of bounds when he gives a valid or invalid signal. He then catches the kick inbounds. **RULING:** There is no rule against a receiver going out of bounds during a kick. The inbounds catch is legal, and the ball is dead.
- III. During a free kick, B21 signals for a fair catch at the B-5. B21 muffs the kick but immediately recovers the ball at the B-5. **RULING:** Not a completed Fair Catch. Team B ball, first and 10 at the B-5.

### No Advance—ARTICLE 2

#### Approved Ruling 6-5-2

- I. B1 gives a fair catch signal before a muff by B2, and then B1 catches or recovers the kick and advances. **RULING:** Because of B1's signal the ball is dead where caught or recovered. Two steps are permitted to enable B1 to come to a stop or to regain balance. A third or subsequent step inbounds is subject to penalty from where the ball is caught or recovered. If B1 is tackled, the tackle is disregarded unless deemed unnecessarily rough or is so late that the tackler should know that there was no intention to advance. If the kick is caught or recovered by Team B in the end zone, it is a touchback. If B1 is tackled before completion of a third step, only the tackler has fouled.
- II. Team A punts. After signaling for a fair catch on his 20-yard line, B1 deliberately lets the ball strike the ground, where B2 recovers the bouncing ball and advances to Team B's 35-yard line. **RULING:** The ball is dead at the spot of recovery. Advance is illegal. Penalty—Five yards from the succeeding spot, the spot of recovery. Team B's ball, first and 10 (Rule 5-2-7).
- III. Punt receiver B22 gives an invalid fair catch signal by a brief flick of his upraised hand. He catches the ball at the B-35 and sprints to the B-40 where he is tackled. **RULING:** The ball is dead where caught. Foul for delay of game by B22; five-yard penalty from the dead-ball spot. No foul by the tackler, as clearly B22 gave the appearance of being a ball carrier. First and 10 for Team B at the B-30.

### Invalid Signals—ARTICLE 3

#### Approved Ruling 6-5-3

- I. A1 or B1 signals for a fair catch beyond the neutral zone during a kick that does not cross the neutral zone. **RULING:** Any signal by Team A is ignored. Team B may not make a fair catch signal because the ball did not cross the neutral zone. However, the ball is dead when caught or recovered (Rules 2-8-1-a and 4-1-3-g).

- II. On a free kick, B17 makes an invalid signal for fair catch near the sideline, muffs the ball, and it goes out of bounds. **RULING:** Team B's ball, first and 10 at the hash mark.
- III. A scrimmage kick strikes the ground beyond the neutral zone and bounces high into the air, and B1 signals for a fair catch. **RULING:** Invalid signal. The ball is dead when recovered.
- IV. B1 catches a scrimmage kick beyond the neutral zone and then signals for a fair catch. **RULING:** Invalid signal. The ball is dead where the signal first was given.
- V. Team A's scrimmage kick is rolling beyond the neutral zone when B17 alerts his teammates to stay away from the ball by a "get away" signal. **RULING:** Invalid signal. The ball is dead by rule when either team recovers.
- VI. While a free kick is in the air, B21 gives a waving signal that does not meet all the requirements of a valid fair catch signal. The ball is caught by: (a) B21 at the B-5; or (b) B44 at the B-5. **RULING:** The ball is dead when caught. (a) Team B ball, first and 10 at the 25-yard line; (b) Team B ball, first and 10 at the 5-yard line.

### Illegal Block or Contact—ARTICLE 4

#### Approved Ruling 6-5-4

- I. B1 gives either a valid or invalid fair catch signal and does not touch a punt. While the untouched ball is loose in the field of play, he blocks an opponent (a) in the field of play beyond the neutral zone or (b) in Team B's end zone. **RULING:** (a) If the ball crosses the neutral zone and Team B has possession when the down ends, Team B is penalized 10 yards from the postscrimmage kick enforcement spot. (b) Safety. The ruling is the same on an unsuccessful field goal attempt.
- II. B1 signals at the 50-yard line and does not touch a punt. While the ball is rolling on the ground at Team B's 45-yard line, B1 uses his hands to shove an opponent to get to the ball and the ball is declared dead in Team B's possession. **RULING:** Penalty—10 yards, postscrimmage kick enforcement. The ball belongs to Team B (Rule 10-2-3).

### No Tackling—ARTICLE 5

#### Approved Ruling 6-5-5

- I. B1 and B2 each signal. B1 muffs, and B2 is about to catch the muffed ball when A1 grabs and pulls him to the ground. **RULING:** Not interference, but holding. Penalty—10 yards from the previous spot or from the spot where the subsequent dead ball belongs to Team B.
- II. B22 makes a fair catch and is tackled before he has carried the ball more than two steps. **RULING:** Foul by the tackler. Penalty—15 yards from the succeeding spot.
- III. B1 catches the punt after B3 signals for a fair catch. **RULING:** The ball is dead when and where caught. B1 is not entitled to catch protection but is entitled to the same protection he has after any other dead ball (Rule 6-5-1-d).

---

# RULE 7

## Snapping and Passing the Ball

---

### Section 1. The Scrimmage

#### Shift and False Start —ARTICLE 2

##### Approved Ruling 7-1-2

- I. After a huddle or shift, all Team A players come to a stop and remain stationary for one second. Then, before the snap, two or more simultaneously change their positions. **RULING:** All 11 Team A players must again stop for one second before the snap, otherwise it is a live-ball foul at the snap for an illegal shift. Penalty—Five yards from the previous spot (Rule 2-22-1).
- II. Ten Team A players shift while A1 remains stationary. A1 then starts moving backward before one second elapses and the ball is snapped. **RULING:** If A1, who moved, did not halt with the other Team A players for one second before the snap, it is a dead-ball foul at the snap for a false start. Penalty—Five yards from the succeeding spot.
- III. After the Team A players have stopped for one second, end A88 runs wide and stops, and before one second elapses, back A36 starts moving backward. **RULING:** Legal. But if back A36 starts before end A88 stops, the simultaneous movement of two players constitutes a shift, and all Team A players must be stationary for one second before the snap (Rule 2-22-1).
- IV. Team A is in a no-huddle offense and is moving to the line when the ball is made ready for play. Although some players settle into their positions and stop, at least one player never stops and is still moving when the ball is snapped. **RULING:** Dead-ball foul: Illegal shift that converts to a false start. Team A never satisfied the one-second rule before the snap. Officials should shut the play down and penalize Team A five yards.
- V. Team A has 3rd and 3 at the B-40. QB A12 is in shotgun formation, (a) makes a fake clap standing in position; (b) makes a fake clap while chucking his shoulders and hands forward in an exaggerated motion simulating the start of the play. **RULING:** Rule 7-1-2-b-4-c states that it is a false start if the quarterback makes any quick, jerky movement that simulates the start of the play. In (a) no foul; (b) false start on A12.

#### Offensive Team Requirements—Prior to the Snap—ARTICLE 3

##### Approved Ruling 7-1-3

- I. A21 is legally on the end of the line of scrimmage next to A88, who is in a three-point stance. Team A stops for one second while A21 and A88 are in



the above positions, and then A21 moves to a legal backfield position and stops. Then A88 moves to a wider position on the line. **RULING:** Legal if both A21 and A88 are stationary at the snap (Rules 2-22-1 and 7-1-4).

- II. A21 is legally on the end of the line of scrimmage next to A88, who is in the stance of a restricted lineman. Team A has stopped for one second when A21 leaves the line of scrimmage and goes in motion into the backfield. A88 moves to a wider position on the line. **RULING:** A88 may break his three-point stance since he is now on the end of the line of scrimmage, but Team A must stop again for one second before the snap to make the play legal (Rule 7-1-4).
- III. B71 crosses the neutral zone into the Team A backfield and does not threaten any Team A player. A23, legally in the backfield, intentionally reaches to contact B71. **RULING:** Team A foul, false start. Penalty—Five yards from the succeeding spot.
- IV. Snapper A1 lifts or moves the ball forward before moving it backward to start the snap. B2 bats the ball, causing it to roll loose with B3 recovering. **RULING:** Team A foul, illegal snap, ball remains dead. Penalty—Five yards from the succeeding spot (Rule 4-1-1).
- V. A66, a restricted lineman between the snapper and the player on the end of the line, or A72, a restricted player on the end of the line of scrimmage:
  1. Lifts a hand or hands from the ground immediately when threatened by B1, who is in the neutral zone. **RULING:** Blow the whistle immediately. Team B dead-ball foul, offside. Penalty—Five yards from the succeeding spot.
  2. Lifts a hand or hands from the ground upon initial charge by B1, who (a) does not enter the neutral zone or (b) enters the neutral zone but does not threaten the position of A66 or A72. **RULING:** In both (a) and (b), blow the whistle immediately. Team A dead ball foul, false start. Penalty—Five yards from the succeeding spot.

*Note: Before the snap, a Team B player who enters the neutral zone may threaten a maximum of three Team A linemen. If the Team B player enters the neutral zone directly toward a Team A lineman, then that Team A player and the two adjacent linemen are considered to be threatened. If the Team B player enters the neutral zone toward a gap between two Team A linemen, then only those two Team A players are considered to be threatened.*

- VI. A80 on the end of the line, a nonrestricted interior lineman or a back, misses the snap count and makes a casual movement that is not abrupt, quick or jerky and does not simulate the start of a play. **RULING:** No foul by Team A.

### **Offensive Team Requirements—At the Snap—ARTICLE 4**

#### **Approved Ruling 7-1-4**

- I. A30, lined up legally as a back, starts in motion legally. He then turns so that he still is legally in motion but is facing his line of scrimmage using a “side-step” motion. At the snap, A30 is bent slightly forward at the waist and is either continuing his “side-step” motion or is “marking time” in place. **RULING:** Legal.



- II. A30, lined up legally as a back, starts in motion legally. He then turns so that he still is legally in motion but is facing his line of scrimmage using a “side-step” motion. At the snap, A30, still behind the neutral zone, is moving slightly forward from the waist up or his “side-step” motion has veered slightly toward the line of scrimmage. **RULING:** Live-ball foul at the snap for illegal motion. Penalty—Five yards from the previous spot.
- III. Team A’s formation at the snap includes only 10 players: five players on the line of scrimmage numbered 50-79, one player on the line wearing number 82, and four players in the backfield. **RULING:** The formation is legal because Team A has no more than four players in the backfield and the required number of players (five) on the line wearing 50-79.
- IV. Team A, with fourth and eight, sends two substitutes numbered 21 and 33 into the game as exceptions to the mandatory numbering, and they are positioned legally on their line of scrimmage between the end players on the line of scrimmage. After the ball is snapped, a Team A player, 15 yards deep in a scrimmage kick formation, throws a legal forward pass to an eligible receiver for a 10-yard gain. **RULING:** Legal play (Note: The same play from a field goal formation is legal).
- V. A33, an exception to the mandatory numbering rule, assumes a position on the line of scrimmage next to end A88. Before the snap, A88 moves to a backfield position and the flanker on the opposite side of the line moves to an end position on the line. **RULING:** Illegal formation. Since A33 is now an end, he is thus in an illegal position at the snap (live-ball foul). Penalty—five yards, previous spot.
- VI. A33, an exception to the mandatory numbering rule, assumes a position on the line of scrimmage to the left of snapper A85, who is on the end of the line. All other Team A players on the line are to A33’s left. After a one-second stop, all players on the line except A85 legally shift to the other side of the ball, with A33 now positioned as an end. **RULING:** If the ball is snapped with A33 in this position, it is a foul for an illegal formation. A33 may not legally be on the end of the line at the snap. Penalty—five yards, previous spot.
- VII. At the B-45, Team A is in an alignment in which the snapper A88 is on the right end of the line. The linemen on his left are numbered 56, 63, 72, 22, 79, and 25. There are four players in the backfield. A44 is ten yards directly behind the snapper, and the other backs are to his left a few yards behind the line of scrimmage. No player is in position to hold for a place kick. After the snap, A44 completes a pass to snapper A88 for a touchdown. This happens on (a) first or second down; (b) third or fourth down. **RULING:** Because there are only four offensive linemen numbered in the 50-79 range, the legality of the play depends on whether Team A is in a scrimmage kick formation. One of the requirements for such a formation is that “it is obvious that a kick will be attempted.” (a) Illegal formation: on first or second down, a team is very unlikely to punt, so it is not obvious that a kick will be attempted. (b) Legal play: touchdown. On third or fourth down a team may be likely to kick. (Rule 2-16-10)
- VIII. Team A lines up with A11 ten yards directly behind the snapper. The other three backs are split wide, all outside the tackle box. Only four Team A linemen have uniform numbers between 50 and 79. A11 receives the

backward pass from the snapper with Team A in this formation. **RULING:** Live-ball foul. Illegal formation, not enough players numbered 50-79 on the line of scrimmage. Team A is not in a scrimmage kick formation, because in this alignment it is not obvious that a kick will be attempted. (Rule 2-16-10)

- IX. Team A lines up with six players on the line of scrimmage, five of whom are numbered in the range 50-79. A seventh player, A88, is in the normal location of an end, but he is positioned so that his feet and shoulders are clearly at a 45-degree angle with the line of scrimmage. The other four players are clearly in the backfield. The ball is snapped with Team A in this alignment. **RULING:** Live-ball foul, illegal formation. Every Team A player must be either a lineman or a back; A88 is neither.

### **Defensive Team Requirements—ARTICLE 5**

#### **Approved Ruling 7-1-5**

- I. Snapper A1 lifts the ball before passing it backward, B2 bats the ball away, and B3 recovers the ball. **RULING:** Team A dead-ball foul, illegal snap. The ball remains dead because it was not put in play by a legal snap. Penalty—Five yards from the succeeding spot. Team A retains possession.
- II. Snapper A1 legally begins the snap, but B2 bats the ball before A1 completes the snap, and B3 recovers the ball. **RULING:** Team B foul and the ball remains dead. Penalty—Five yards from the succeeding spot. Team B may not touch the ball until it has been snapped. Team A retains possession.
- III. Before the snap, a Team B player crosses the neutral zone and, without making contact, continues his charge behind a Team A lineman and directly toward the quarterback or kicker. **RULING:** A Team B player who is on Team A's side of the neutral zone and is moving in a direct path toward the quarterback or kicker while he is behind an offensive lineman is considered to be interfering with Team A's formation. Penalty—Team B dead-ball foul, offside. Five yards from the succeeding spot.
- IV. Linebacker B56 is stationary within one yard beyond the neutral zone. As the offense is calling its snap signals, B56 feints toward the line in an obvious attempt to induce a false start by the offense. **RULING:** Dead-ball foul, delay of game. Five-yard penalty at the succeeding spot.

### **Handing the Ball Forward—ARTICLE 6**

#### **Approved Ruling 7-1-6**

- I. Eligible receiver A83 is on the end of his scrimmage line and adjacent to the snapper in an unbalanced "T" formation. Quarterback A10 receives a handed snap and immediately conveys the ball to A83. **RULING:** If the movement of the ball is forward and it left A10's hand before having been touched by A83, it is a legal forward pass. A83 may have turned sufficiently to receive a backward pass or handoff (legal); but if the action immediately followed the snap, it is not likely that a handoff would have had time to comply with the "turn" and "two yards behind the line" requirement.

## Section 2. Backward Pass and Fumble

### Out of Bounds—ARTICLE 4

#### Approved Ruling 7-2-4

- I. B20 intercepts a legal forward pass (a) in his end zone, (b) on his three-yard line, and his momentum carries him into his end zone, or (c) in the field of play and retreats into his end zone (no momentum). In each instance, B20 fumbles in the end zone and the ball rolls forward and out of bounds on Team B's two-yard line. **RULING:** The ball belongs to Team B at the spot of the fumble (Team B's end zone); (a) touchback, (b) Team B's ball at the three-yard line, and (c) safety (Rules 8-5-1 and 8-6-1).
- II. On second down, A1 fumbles the ball, which strikes the ground and bounces high in the air. B2 receives the ball while off the ground and returns to the ground out of bounds (a) in advance of the spot of the fumble or (b) behind the spot of the fumble. **RULING:** (a) Team A's ball at the spot of the fumble. (b) Team A's ball at the spot where the ball crossed the sideline (Rules 4-2-4-d and 7-2-4).

## Section 3. Forward Pass

### Illegal Forward Pass—ARTICLE 2

#### Approved Ruling 7-3-2

- I. Quarterback A10, who is not outside the tackle box and is attempting to save yardage, intentionally throws a desperation forward pass that falls incomplete where there is no eligible Team A receiver. **RULING:** Intentional grounding. Penalty—Loss of down at the spot of the foul. The clock starts on the snap (Rule 3-3-2-d-4) unless Rule 3-4-4 applies.
- II. Late in either half with more than one minute remaining, A10 is unable to locate an open receiver. To conserve time, he throws a forward pass that is incomplete where there is no eligible Team A player. **RULING:** Illegal forward pass, intentional grounding. Penalty—Loss of down at the spot of the foul. The clock will start on the ready-for-play signal (Rule 3-3-2-e-14 and 3-4-3).
- III. On third down near the end of either half, potential field goal holder A4 muffs the snap and A4 or potential kicker A3 recovers the ball and immediately throws it forward to the ground. **RULING:** Illegal forward pass for intentional grounding; not a valid attempt to conserve time. Penalty—Loss of down at the spot of the foul. 10-second runoff option for Team B (Rule 3-4-4). Clock starts on the ready-for-play signal (Rules 3-3-2-e-14 and 3-4-3) if the 10-second runoff is accepted.
- IV. The ball is snapped over the head of quarterback A12, who is in the "shotgun" formation. A12 recovers the ball and immediately throws it forward to the ground. **RULING:** Illegal forward pass for intentional grounding; not a valid attempt to conserve time. Penalty—Loss of down at the spot of the foul. Clock starts on the ready-for-play signal (Rules 3-3-2-e-14 and 3-4-3).
- V. On third down near the end of the half, A1 muffs the snap. A1 or A4 catches the muffed ball and immediately throws it forward into the ground. **RULING:** Legal play.

- VI. On third down near the end of the half, A1—positioned seven yards behind the snapper—catches the snap and immediately throws the ball forward to the ground. **RULING:** Legal play.
- VII. With seconds remaining in a half and the ball ready for play, Team A quickly lines up and the ball is legally snapped to quarterback A12, who throws the ball forward directly to the ground. Team A's formation was not legal at the snap. When the ball becomes dead, two seconds show on the game clock. **RULING:** Illegal formation. Penalty—Five yards from the previous spot. The clock starts on the snap.
- VIII. Quarterback A10 sprints toward a sideline and is outside the tackle box when he throws a legal forward pass that is batted down by a defensive lineman and lands behind the neutral zone. **RULING:** Legal play. Without the batting the ball would have landed beyond the neutral zone, so A10 has satisfied the spirit of the rule.
- IX. Third and 5 at the A-40. QB A12 drops back in the pocket to pass. Under a heavy rush he throws a backward pass to back A22 who carries the ball outside the tackle box. About to be tackled, A22 at the A-35 throws a forward pass that crosses the neutral zone and lands in an area 20 yards away from the nearest Team A eligible receiver. **RULING:** Foul, intentional grounding. The tackle-box rule exception applies only to the player who controls the snap or the resulting backward pass. Loss of down at the spot of the foul. Fourth and 10 at the A-35. (Rule 7-3-2-h-Exc.)
- X. Quarterback A12 is in a shotgun formation. He muffs the backward pass from the snapper and the ball is picked up by A63 inside the tackle box. Under a heavy rush, A63 gets outside the tackle box and throws the ball incomplete beyond the line of scrimmage. **RULING:** Legal play. A63 controlled the backward pass that resulted from the snap. (Rule 7-3-2-h-Exc.)
- XI. 2/10 @ A-40. In a shotgun formation A11 takes the backward pass from the snapper and hands the ball off to back A44. A44 takes a few steps toward the line of scrimmage and then throws a backward pass to A11, who is still inside the tackle box. Avoiding tacklers, A11 scrambles outside the tackle box, and unable to find an open receiver, at the A-35 he throws the ball toward an area where there are no eligible receivers, and it lands out of bounds beyond the neutral zone. **RULING:** Illegal forward pass. Loss of down at the A-35; third and 15. A11 loses the right to throw the ball away legally because he relinquishes possession before passing it.
- XII. 3/10 @ A-30. Quarterback A11 drops back to pass. About to be tackled at the A-20, he throws the ball forward to an area where there are no eligible receivers. Tackle A77 catches the pass at the A-28 and is tackled at the A-32. **RULING:** Illegal forward pass; loss of down at the spot of the pass. Fourth and 20 at the A-20. This is “intentional grounding” since A11 throws the ball into an area where there are no eligible Team A receivers. Note that this is not illegal touching by A77, because the rule for illegal touching applies only to a legal forward pass. (Rule 7-3-11)
- XIII. Quarterback A11 drops back to pass and scrambles outside the tackle box. He fumbles the ball, which bounces back up into his hands. He then passes the ball forward, and it lands beyond the neutral zone in an open area

where there are no eligible receivers with an opportunity to make a catch.  
**RULING:** Legal play, since A11 did not relinquish possession to another player.

### Eligibility Lost by Going Out of Bounds—ARTICLE 4

#### Approved Ruling 7-3-4

- I. Eligible A88 voluntarily goes out of bounds, returns inbounds, and is the first player to touch the legal forward pass. This touching by A88 occurs in Team B's end zone. **RULING:** Illegal touching. Penalty—Loss of down at the previous spot.
- II. Eligible A88 voluntarily goes out of bounds during a down in which a legal forward pass is thrown. He returns to the field of play inbounds but does not touch the ball and is held by an opponent before the ball is touched by any player. **RULING:** Not pass interference—A88 is not eligible to catch a legal forward pass. Penalty—Ten yards from the previous spot and automatic first down.
- III. Wide receiver A88 is blocked out of bounds by B1 and then runs 20 yards before returning inbounds to the field of play. A88 catches a legal pass in Team B's end zone. **RULING:** Foul for illegal touching due to A88's failure to return inbounds immediately. Penalty—Loss of down at the previous spot.
- IV. Eligible receiver A44 is running a pass pattern near the sideline. As a legal forward pass comes toward him, he accidentally steps on the sideline, leaps, muffs the pass into the air while airborne, returns to the ground inbounds, grabs the ball and lands on his knees inbounds with the ball firmly in his possession. **RULING:** Incomplete pass. A44 first touched the ball while airborne and thus out of bounds since he had not established in bounds. (Rule 2-27-15)

### Eligibility Gained or Regained—ARTICLE 5

#### Approved Ruling 7-3-5

- I. Team B touches the legal forward pass near a sideline while originally eligible A1 is out of bounds. A1 comes inbounds and touches the pass. **RULING:** Legal play. Touching by Team B made all players eligible during the remainder of the down.

### Completed Pass—ARTICLE 6

#### Approved Ruling 7-3-6

- I. Two opposing players receive a legal forward pass while both are off the ground, and both players return to the ground inbounds at the same time. **RULING:** Simultaneous catch; the ball is awarded to the passing team (Rule 2-4-4).
- II. Two opposing players receive a ball while both are off the ground, and one player returns to the ground inbounds before the other. **RULING:** No simultaneous catch. The legal forward pass is completed or intercepted by the player who first returned to the ground (Rule 2-4-4).
- III. An inbounds airborne player receives a legal forward pass. While still in the air, he is tackled by an opponent and obviously held for a moment before being carried in any direction. He then lands inbounds or out of bounds

- with the ball. **RULING:** Completed pass. The ball is dead at the yard line where the receiver/interceptor was held in a manner that prevented him from immediately returning to the ground (Rule 4-1-3-p).
- IV. Airborne A80 receives a legal forward pass at his 30-yard line. While still in the air, he is tackled by B40 and driven forward to Team A's 34-yard line, where he is downed. **RULING:** Team A's ball at its 34-yard line (Rule 5-1-3-a).
- V. Airborne A80 receives a legal forward pass at his 30-yard line. While still in the air, he is tackled by B40 and driven backward to Team A's 26-yard line, where the ball becomes dead. **RULING:** Team A's ball at the 30-yard line (Rule 5-1-3-a Exception).
- VI. A86 is legally blocked out of bounds by B18 at Team B's two-yard line. A86, while attempting an immediate return to the field of play, leaps from out of bounds and is airborne as he receives A16's legal forward pass. He lands in Team B's end zone with the ball in his grasp. **RULING:** Incomplete pass. A86 did not establish in bounds before touching the pass, and hence he was still out of bounds. (Rule 2-27-15)
- VII. B33 leaps from in bounds and is airborne as he receives Team A's legal forward pass. He completes the interception by landing (a) in the field of play or (b) in Team B's end zone, and is then tackled. **RULING:** B33 is a ball carrier until he loses player possession or the ball becomes dead by rule. (a) First and 10 for Team B. (b) Touchback. (Rules 4-1-3-c, 4-2-3-a, 5-1-1-e and 7-3-4).
- VIII. While airborne and in bounds, eligible receiver A89 touches a forward pass when he propels it toward: (a) eligible receiver A80, who catches the pass; or (b) B27, who intercepts the pass. **RULING:** Legal play, and the ball remains live in both (a) and (b). A89 has batted a forward pass (Rules 2-4-3, 2-11-3 and 9-4-1-a).
- IX. Airborne receiver A85 grasps a forward pass and in the process of going to the ground, first contacts the ground with his left foot as he falls to the ground inbounds. Immediately upon A85 hitting the ground, the ball comes loose and touches the ground. **RULING:** Incomplete pass. An airborne receiver must maintain control of the ball while going to the ground in the process of completing a catch.
- X. Airborne receiver A85 grasps a forward pass and in the process of going to the ground, first contacts the ground with his left foot as he falls to the ground inbounds. Immediately upon A85 hitting the ground, the ball comes loose but never touches the ground before he regains control. **RULING:** Catch. If the receiver is inbounds and is going to the ground and loses control, as long as the player remains inbounds and the ball never touches the ground, it is a completed pass.
- XI. Airborne receiver A85 grasps a forward pass and in the process of going to the ground, first contacts the ground with his left foot inbounds as he falls to the ground out of bounds. Immediately upon A85 hitting the ground out of bounds, the ball comes loose. **RULING:** Incomplete pass regardless of whether or not the ball hits the ground because the receiver is out of bounds.

- XII. Receiver A85 stretches out at the Team B two-yard line and grasps a forward pass and is going to the ground on his own as he is attempting to complete the catch. As A85 falls to the ground in the end zone, the ball immediately comes loose and falls to the ground. **RULING:** Incomplete pass. Any receiver going to the ground on his own in the process of making a catch must maintain control of the ball when he hits the ground.
- XIII. Receiver A85 is airborne and in bounds in the end zone and grasps a forward pass, but while airborne he is hit by a defender, which causes A85 to fall to the ground. Immediately upon A85 hitting the ground, the ball comes loose and strikes the ground. **RULING:** Incomplete pass. An airborne receiver contacted before completing all the requirements of a catch must still maintain control of the ball after hitting the ground.
- XIV. Eligible A80 is airborne when he receives a legal forward pass. He grasps the ball firmly in his hands, and as he is returning toward the ground, the nose of the football touches the ground before any part of his body. A80 retains his firm control of the ball and it does not move during this action. A80's knees then touch the ground and he maintains control of the ball. **RULING:** Completed pass.
- XV. Eligible A80 is airborne near the sideline when he receives a legal forward pass. As he comes to the ground facing the field of play, his toe (a) clearly drags the ground inbounds before he falls out of bounds; (b) touches the ground inbounds and then his heel comes down on the sideline in a continuous motion. He maintains firm control of the ball in both cases. **RULING:** (a) Complete pass. (b) Incomplete pass. The continuous toe-heel touching is part of a single process and by interpretation he has landed out of bounds, thus not executing a catch.

### **Incomplete Pass—ARTICLE 7**

#### **Approved Ruling 7-3-7**

- I. A player touches a legal forward pass (a) while he is contacting a boundary line; (b) while airborne after having leaped from out of bounds. **RULING:** (a) and (b) The ball is out of bounds, the pass is incomplete, and the down counts. The player loses his eligibility when he goes out of bounds (Rules 2-27-15, 4-2-3-a, and 7-3-3).
- II. Fourth and nine on Team A's six-yard line. A1 intentionally grounds a forward pass in his end zone to save loss of yardage. **RULING:** Team B may accept the penalty for a safety. If they decline the penalty, it is Team B's ball, first and goal on the six-yard line.
- III. Third and nine on Team A's six-yard line. A1 throws a second forward pass from his end zone. B2 intercepts and is downed on Team A's 20-yard line. **RULING:** Team B may accept the penalty which results in a safety, or take the result of the play, retaining the ball for a first down on Team A's 20-yard line.

### **Illegal Contact and Pass Interference—ARTICLE 8**

#### **Approved Ruling 7-3-8**

- I. B33, defending against a legal forward pass beyond the neutral zone, has his back to the ball and is waving his arms in the face of eligible A88, but



does not make contact. **RULING:** No foul. There is no foul for defensive pass interference if there is no contact.

- II. Wide receiver A80, 15 yards beyond the neutral zone, turns his back toward the neutral zone. The passer throws the ball high over A80's hands, which are extended above his head. The ball is overthrown and beyond the receiver (uncatchable pass) when B2 pulls A80 down by the facemask. **RULING:** Personal foul (Rule 9-1-12-a), not pass interference. Penalty—15 yards from the previous spot. First and 10 for Team A. Flagrant offenders shall be ejected.
- III. A83, a wide receiver 10 yards from the nearest interior lineman, slants toward the middle of the field. Before the ball is thrown, B1, a back, legally blocks him and knocks him down. **RULING:** Legal unless the block was below the waist (Rule 9-1-6).
- IV. At the snap, A88 is on the end of the line of scrimmage 10 yards from the tackle position and A44 is in the backfield, four yards to his inside. Just before the Team A passer releases the ball, A88 contacts B1 five yards beyond the neutral zone. The pass is thrown to A44, who has moved in front and to the outside of the spot where A88 had contacted B1. **RULING:** Team A foul, offensive pass interference. Penalty—15 yards from the previous spot.
- V. Before the ball is thrown, wide receiver A88 moves four yards downfield directly toward and in front of the defender, B1. At this spot, B1 pushes A88, who then uses his hands to contact B1. **RULING:** Team A foul, offensive pass interference, if the legal forward pass is beyond the neutral zone. Penalty—15 yards from the previous spot.
- VI. Before the ball is thrown, wide receiver A88 slants to the inside where linebacker B1 attempts to block him. A88 uses his hands to shove B1 away. **RULING:** Team A foul, offensive pass interference, if the legal forward pass crosses the neutral zone. If B1's initial contact was below the waist and beyond the neutral zone, Team B also has fouled and the live-ball fouls offset.
- VII. A88, a spread receiver, runs a 10-yard route and cuts 90 degrees to the sideline. After the ball is thrown, B2 contacts A88 with a tackle, block, grasp or push before A88 touches the ball, a catchable forward pass. **RULING:** Team B foul, defensive pass interference. Penalty—Spot foul and first down.
- VIII. A80, a tight end, runs 10 yards into the secondary and cuts toward the goal posts. B1 is one step behind and to the outside when he recovers. After the legal forward pass has been thrown, B1 contacts A80 with a tackle, block, grasp or push as the ball goes over A80's outstretched hands. **RULING:** Team B foul for defensive pass interference. Penalty—Spot foul and a first down if the infraction occurs less than 15 yards from the previous spot; 15-yard penalty from the previous spot and a first down if the foul is more than 15 yards beyond the neutral zone.
- IX. A88 and B2 are running closely together before or after the ball has been thrown. Either A88 or B2 or both fall when their feet become entangled. Neither player was tripped intentionally. **RULING:** No foul.



- X. Before the pass is thrown, wide receiver A88 and defender B1 are running shoulder to shoulder and side by side 15 yards beyond the neutral zone. A88 is nearest to the sideline, and B1 is nearest to the hash mark. A88 breaks to the inside. B1 does not move, and A88 collides with him. **RULING:** No foul because the ball has not been thrown.
- XI. Wide receiver A88 and defender B1 are running shoulder to shoulder and side by side 15 yards beyond the neutral zone. A88 is nearest to the sideline, and B1 is nearest to the hash mark. A legal forward pass is thrown toward the goal post. While the ball is in the air, A88 breaks to the inside toward the catchable forward pass. B1 does not move and makes no attempt to go for the pass, and A88 collides with him. **RULING:** Team B foul, defensive pass interference. Penalty—15 yards from the previous spot and a first down.
- XII. A44, a slot back, runs a pattern 25 yards downfield toward the goal line pylon. B1, a safety, is positioned between A44 and the pylon when the ball is thrown. B1 obviously reduces his speed and collides with A44 before the catchable ball touches the ground. **RULING:** Team B foul, defensive pass interference. Penalty—15 yards from the previous spot and first down.
- XIII. A80, a tight end, moves across the formation on a pass pattern at a depth of 25 yards where he contacts B1, a safety, before or after the ball has been thrown. A88, a wide receiver positioned on the opposite side from the tight end at the snap, crosses behind the contact of A80 and B1 and catches the legal forward pass. **RULING:** Team A foul, offensive pass interference. Penalty—15 yards from the previous spot.
- XIV. Fourth and goal for Team A on Team B's five-yard line. Team A's legal forward pass is incomplete, but Team B interfered on its one-yard line or in its end zone. **RULING:** First and goal for Team A on Team B's two-yard line.
- XV. A80 and B60 are attempting to catch a forward pass thrown toward A80's position, which is beyond the neutral zone. The pass is high and ruled uncatchable. As the ball passes overhead, A80 pushes B60 in the chest. **RULING:** Not offensive pass interference.
- XVI. On a legal forward pass beyond the neutral zone, A80 and B60 are attempting to catch the pass thrown to A80's position. A14, who is not attempting to catch the pass, blocks B65 downfield, either before the pass is thrown or while the uncatchable pass is in flight. **RULING:** Team A foul, offensive pass interference. Penalty—15 yards from the previous spot.

## Contact Interference—ARTICLE 9

### Approved Ruling 7-3-9

- I. A legal forward pass beyond the neutral zone is tipped or muffed by an eligible receiver of either team or glances off an official. Then, while the pass is still in flight, either Team A or Team B holds or otherwise fouls an eligible opponent who is beyond the neutral zone. **RULING:** Interference rules do not apply after the pass has been touched. Penalize as a foul during a loose ball. Penalty—10 or 15 yards from the previous spot (Rule 9-3-6).
- II. On a legal forward pass behind the neutral zone, eligible A1 "has position" on B1 and is about to touch the pass when B1 pushes A1 and the pass is

incomplete. **RULING:** Legal. Interference rules do not apply behind the neutral zone (Rules 7-3-9-d, 9-1-5 Exception 4 and 9-3-6 Exception 5).

- III. Running a pattern near the sideline, end A88 touches the sideline just before a defender jumps into him and bats the ball to the ground. **RULING:** Not defensive pass interference. A88 became ineligible when he stepped out of bounds. (Rule 7-3-3)

### Ineligible Receiver Downfield—ARTICLE 10

#### Approved Ruling 7-3-10

- I. Ineligible lineman A70 runs more than three yards beyond the neutral zone and does not make contact with an opponent. He circles toward the flank and returns across the neutral zone before A10 throws a legal forward pass that crosses the neutral zone. **RULING:** Ineligible downfield. Penalty—Five yards from the previous spot.
- II. Ineligible lineman A70 makes contact with an opponent within one yard of the neutral zone. A70 drives B4 more than three yards beyond the neutral zone and then circles back across the neutral zone before A1 throws a legal forward pass that crosses the neutral zone. **RULING:** Team A foul, offensive pass interference. Penalty—15 yards from the previous spot (Rule 7-3-8-b).
- III. First and 10 at the A-37. Ineligible lineman A70 releases at the snap and starts downfield. When the passer releases the ball, the top of A70's helmet is penetrating the plane of the A-40. The pass crosses the neutral zone and falls incomplete at the A-39. **RULING:** Foul, ineligible receiver downfield. Some part of A70's body was more than three yards beyond the neutral zone when the pass was released.

### Illegal Touching—ARTICLE 11

#### Approved Ruling 7-3-11

- I. Late in the half, quarterback A10, who has not been outside the tackle box, throws a desperation pass to intentionally save yardage that falls incomplete after ineligible A58 touches the ball in an attempt to catch it. **RULING:** Foul for intentional grounding. No foul for illegal touching since the pass is illegal. Penalty—Loss of down at the spot of the pass. The clock starts on the snap (Rules 3-3-2-d-4 and 7-3-2-h). Rule 3-4-4 applies if less than one minute remains on the game clock. If time expires in the quarter the quarter is not extended.
- II. Team A snaps on its 10-yard line. A10 retreats and then passes forward to ineligible A70 who, while in his end zone, (a) touches the ball as he attempts to catch the pass, and the pass is incomplete; (b) catches the pass and is downed in the end zone; or (c) catches the pass and is downed after having advanced to his three-yard line. **RULING:** (a) Team B may accept the five-yard penalty from the previous spot that includes loss of down, so the down will count. (b) The ball is dead in the end zone with impetus by Team A, and Team B may elect the safety or the penalty at the previous spot with loss of down. (c) Five-yard penalty from the previous spot and loss of down. The down counts if the penalty is declined; the dead-ball spot might be deemed more advantageous to Team B than the penalty [Note: (a), (b) and (c) could be intentional grounding depending on the

location of an eligible Team A player or the location of A10 when the ball is thrown] (Rule 10-1-1-b). If intentional grounding is warranted, there is no illegal touching.]

### **Team B Personal Foul/Unsportsmanlike Conduct During Legal Forward Pass Play--ARTICLE 12**

#### **Approved Ruling 7-3-12**

- I. A11 throws a forward pass intended for A88. During the play defensive end B88 is flagged for a head-slap to tackle A79. The pass to A88 is (a) complete for a 10-yard gain to the A-30 where A88 is tackled. (b) incomplete or intercepted. **RULING:** (a) The penalty is enforced at the end of the run, which is the A-30; first and 10 for Team A at the A-45. (b) The penalty is enforced at the previous spot, first and 10 for Team A at the A-35. (Rule 9-1 Penalty)
- II. A11 throws a forward pass intended for A88. During the pass defensive end B88 is flagged for a unsportsmanlike conduct. The pass to A88 is (a) complete for a 10-yard gain to the A-30 where A88 is tackled. (b) incomplete or intercepted. **RULING:** (a) The penalty is enforced at the end of the run, which is the A-30; first and 10 for Team A at the A-45. (b) The penalty is enforced at the previous spot, first and 10 for Team A at the A-35. (Rule 9-2-1-a-1 Penalty)

---

# RULE 8

## Scoring

---

### Section 2. Touchdown

#### How Scored—ARTICLE 1

##### Approved Ruling 8-2-1

- I. Ball carrier A1, while attempting to score, strikes the pylon located on the right intersection of the goal line and sideline with his foot. He is carrying the ball in his right arm, which is extended over the sideline. **RULING:** Whether or not a touchdown is scored depends on the forward progress of the ball as related to the goal line when the ball becomes dead by rule (Rules 4-2-4-d and 5-1-3-a).
- II. Ball carrier A1, advancing in the field of play, becomes airborne at the two-yard line. His first contact with the ground is out of bounds three yards beyond the goal line. The ball, in possession of the ball carrier, passes over the pylon. **RULING:** Touchdown (Rule 4-2-4-d).
- III. The ball, in possession of airborne ball carrier A21, crosses the sideline above the one-yard line, continues beyond the pylon and is then declared dead out of bounds in possession of A21. **RULING:** Ball is declared out of bounds at the one-yard line (Rules 2-12-1 and 4-2-4-d).
- IV. Quarterback A12 completes a forward pass to a teammate who is standing in Team B's end zone. (a) A12 is beyond the neutral zone when he releases the ball. (b) The receiver is wearing uniform number 73. **RULING:** In (a) and (b) the result of the play is a touchdown. The penalty is completed according to Team B's options.
- V. Ball carrier A22 dives for the goal line at the B-1. The ball in his possession (a) touches the pylon; (b) goes over the top of the pylon; (c) crosses the goal line inside the pylon. A22 then first contacts the ground out of bounds three yards beyond the goal line. **RULING:** (a), (b) and (c) Touchdown in all three. The ball in A22's possession has broken the plane of the goal line in all three scenarios.
- VI. Ball carrier A22 heads for the right-hand pylon at the goal line. At the B-2 he dives or is blocked into the air by an opponent. The ball in A22's right hand crosses the sideline at the B-1 and passes outside the pylon, and then A22 (a) touches the pylon with his foot or left hand; (b) first touches the ground out of bounds three yards beyond the goal line. **RULING:** (a) Touchdown. The goal-line plane is extended since A22 touches the pylon. (b) Not a touchdown. The goal-line plane is not extended because A22 did not touch either the pylon or the ground in the end zone. The ball is ruled out of bounds at the B-1.

- VII. Ball carrier A22 heads for the right-hand pylon at the goal line. The ball in his right hand crosses the extension of the goal line outside (i.e., to the right of) the pylon, and then A22 steps (a) on the goal line; (b) on the sideline inches short of the goal line. **RULING:** (a) Touchdown. The goal-line plane is extended because A22 touches the ground in the end zone. (b) Not a touchdown. The goal-line plane is not extended. The ball is ruled out of bounds at the crossing point.
- VIII. Ball carrier A22 heads for the right-hand pylon at the goal line. The ball is in his right hand. His foot hits the pylon just before the ball crosses (a) the pylon or (b) the extension of the goal line just to the right (outside) of the pylon. **RULING:** (a) and (b) No touchdown in either case. Because the pylon is out of bounds the ball is dead when A22's foot hits it. Thus in both cases the ball is dead before it crosses the goal line.
- IX. Ball carrier A1 is hit and his forward progress stopped inbounds near the goal line at the sideline to his right. When he is stopped he has the ball in his right hand extended beyond the goal line (a) inside the pylon; (b) outside the pylon. **RULING:** (a) Touchdown. The ball became dead when he extended it beyond the goal-line plane. (b) Not a touchdown, because no part of his body touches either the pylon or the end zone. In this case the goal-line plane is not extended.
- X. Ball carrier A33 is running toward the Team B goal line. A33 drops the ball at the one-yard line, circles through the end zone and runs to the team area, believing a touchdown has been scored. There is no touchdown signal by any official. The fumbled ball hits the ground just outside the goal line, rolls along the ground in the end zone, and is declared dead there when it comes to rest and no player attempts to recover it. **RULING:** When a fumble comes to rest inbounds and no player attempts to secure the ball in advance of the spot of the fumble, the ball belongs to the fumbling team at the spot of the fumble. Team A's ball at the 1-yard line.

### Section 3. Try Down

#### How Scored—ARTICLE 1

##### Approved Ruling 8-3-1

- I. During a try, after having obtained possession, Team B fumbles and Team A recovers in the Team B end zone. **RULING:** Team B can fumble after intercepting a pass, catching or recovering a fumble or recovering a backward pass. Touchdown. Award Team A two points (Rule 8-3-2-d-1).
- II. B19 is the first player beyond the neutral zone to touch Team A's blocked kick try when B19 muffs the in-flight kick in the end zone. A66 recovers in the end zone. **RULING:** Award Team A two points.

#### Opportunity to Score—ARTICLE 2

##### Approved Ruling 8-3-2

- I. On a try attempt, B2 adds new impetus to a Team A fumble that is recovered in the Team B end zone by Team B. **RULING:** Safety, award Team A one point (Rules 8-3-1 and 8-5-1).
- II. On a try attempt, B2 kicks a Team A fumble into the Team B end zone where Team B recovers while grounded. **RULING:** Safety, one point for

- Team A, or Team A may accept the penalty for illegally kicking the ball (Rules 8-3-1 and 8-3-3-b-1) and repeat the down.
- III. On a one-point try attempt, B2 blocks A1's kick. The ball, which does not cross the neutral zone, is picked up by A2, and he advances the ball across Team B's goal line. **RULING:** Award Team A two points (Rule 8-3-1).
- IV. On a one-point try attempt, Team A's kick is blocked. A2 picks up the ball beyond the neutral zone in the field of play. **RULING:** The ball is dead where picked up by A2. The try is ended.
- V. On a one-point try attempt, Team A's kick is blocked. The ball, untouched beyond the neutral zone, (a) is recovered by B3 on his one-yard line or (b) hits the ground in Team B's end zone. **RULING:** (a) B3 may advance the ball. (b) The ball is dead the try is ended (Rule 8-3-1).
- VI. On a one-point try attempt, Team A's kick is blocked. B3 recovers the ball and advances across Team A's goal line. During B3's run, B4 clips. **RULING:** No score, the try is ended, and the penalty is declined by rule (Rule 8-3-4-b).
- VII. On a try attempt, B1 intercepts Team A's legal forward pass in his end zone. He runs the ball across Team A's goal line, and (a) there are no fouls during the run, (b) B3 clips during the run or (c) A2 fouls during the run. **RULING:** (a) Award Team B two points. (b) No score, the try is ended, and the penalty is declined by rule. (c) Award Team B two points, and the penalty is declined by rule (Rules 8-3-1 and 8-3-4-a and b).
- VIII. On a try attempt, A1 muffs the hand-to-hand snap from the snapper. A2 recovers the ball and carries it into Team B's end zone. **RULING:** Award Team A two points (Rule 2-11-2).
- IX. On a one-point try attempt, Team A's kick is blocked and B75 recovers at the two-yard line. B75 then fumbles and the ball rolls into the end zone, where B61 recovers while grounded. **RULING:** Safety. Award Team A one point (Rule 8-1-1).

### Fouls During a Try Before Team B Possession—ARTICLE 3

#### Approved Ruling 8-3-3

- I. During a try attempt, Team A's legal kick, untouched and in the air, has crossed the neutral zone when a foul occurs. **RULING:** If the foul is by Team A and the try is unsuccessful, and Team B does not gain possession, the try ends. If the foul is by Team A and the try is successful, the penalty is at the previous spot. If the foul is by Team B and the try is successful, score the point unless Team A chooses to accept the penalty and attempt a two-point play. The try is exempt from postscrimmage kick enforcement. Penalties for Team B personal fouls on a successful try may be enforced on the subsequent kickoff or at the succeeding spot in extra periods. If the try is unsuccessful, Team A may accept the penalty and the down will be repeated.
- II. Both teams foul during a try, and Team B had not gained possession. **RULING:** Repeat the down at the previous spot.
- III. Lined up for the try at the middle of the B-3, Team A commits a false start and is penalized to the B-8. The kick attempt is blocked, but B77 was in the neutral zone at the snap. The penalty takes the ball to the B-4 for the

repeat of the down. Team A requests that the ball be placed at the right hash mark. **RULING:** The officials grant the request and the ball is made ready for play at the B-4 on the right hash mark.

- IV. During a try, both teams foul before Team B intercepts a forward pass. On the return, (a) B23 clips or (b) A18 tackles the ball carrier by twisting his face mask. **RULING:** (a) and (b) The fouls offset and the down is repeated.
- V. During a try, B79 is in the neutral zone at the snap. B20 intercepts a forward pass and A55 tackles him by pulling the face mask. **RULING:** The fouls offset and the down is repeated.

### **Fouls During a Try After Team B Possession—ARTICLE 4**

#### **Approved Ruling 8-3-4**

- I. B15 intercepts Team A's legal forward pass and is running at midfield when tackled by A19, who grasps and pulls B15's face mask. **RULING:** The penalty is declined by rule and the try is ended.
- II. B1 intercepts Team A's legal forward pass and runs it to midfield. During the run of the interception, B2 clips in Team B's end zone. **RULING:** The penalty is declined by rule.
- III. During a two-point try attempt, Team A is flagged for an illegal shift. B21 recovers a fumble and on the return, B45 clips and A80 punches an opponent. B21 carries the ball across the goal line. **RULING:** The score does not count, the fouls cancel, the down is not repeated and the try is ended. A80's foul for fighting will be enforced on the succeeding kickoff or at the succeeding spot in extra periods. A80 is ejected.
- IV. During a two-point try attempt, Team A is flagged for an illegal shift. B21 recovers a fumble and on the return, A80 punches an opponent. B21 carries the ball across the goal line. **RULING:** The score counts and the penalty for A80's flagrant foul is enforced on the succeeding kickoff or at the succeeding spot in extra periods. A80 is ejected.

## **Section 4. Field Goal**

### **Next Play—ARTICLE 2**

#### **Approved Ruling 8-4-2**

- I. Fourth and eight on Team B's 40-yard line. Team A's untouched field goal attempt rolls dead on Team B's seven-yard line. **RULING:** Team B's ball at Team B's 40-yard line.
- II. Fourth and eight on Team B's 40-yard line. Team A's attempted field goal touches B1 at the 10-yard line and goes out of bounds at the five-yard line. **RULING:** Team B's ball at Team B's five-yard line.
- III. Fourth and eight on Team B's 40-yard line. Team A's attempted field goal strikes the ground at the three-yard line and bounces into the end zone, where it is received in the air and then downed by a Team B player. **RULING:** Touchback (Rule 8-6-1-b). Team B's ball at the 20-yard line.
- IV. Fourth and eight on Team B's 18-yard line. Team A's unsuccessful field goal attempt goes out of the end zone. **RULING:** Team B's ball at the 20-yard line.

- V. Team A's unsuccessful field goal attempt strikes the ground beyond the neutral zone and bounces back across the neutral zone, where it is recovered by B1 and advanced into the end zone. **RULING:** Touchdown (Rule 6-3-5).
- VI. Fourth and six on Team B's 18-yard line. Team A's unsuccessful field goal attempt strikes the ground beyond the neutral zone and bounces back across the neutral zone to Team B's 28-yard line, where it goes out of bounds or is recovered and downed by either team. The kick is untouched beyond the neutral zone. **RULING:** Team B's ball, first and 10 at Team B's 28-yard line (Rules 6-3-6, 6-3-7, and 8-4-2-b).
- VII. Team A snaps the ball at the B-15 to attempt a field goal. The kick is blocked, crosses the neutral zone and lands at the B-12. Before any player touches it beyond the neutral zone, the ball rebounds behind the neutral zone and goes out of bounds at the (a) B-17; (b) B-25. **RULING:** (a) Team B's ball, first and 10 at the B-17; (b) Team B's ball, first and 10 at the B-25. (Rules 6-3-7 and 8-4-2-b)
- VIII. Fourth and goal at the B-10. The field goal attempt is blocked and hits the ground at the B-7. It then rebounds to the B-13 where B44 muffs it. A44 recovers at the B-11. **RULING:** First and 10 for Team A at the B-11. Team B has touched a scrimmage kick that has crossed the neutral zone. (Rule 6-3-3)

## Section 5. Safety

### How Scored—ARTICLE 1

#### Approved Ruling 8-5-1

- I. A10, after receiving the snap in his own end zone, is downed with the ball resting on his goal line, its forward point being in the field of play. **RULING:** Safety. A part of the dead ball is on the ball carrier's goal line.
- II. A scrimmage kick fails to cross the neutral zone, or crosses the neutral zone and is first touched by Team B, or is untouched and then rebounds into the end zone, where it is declared dead in Team A's possession. **RULING:** Safety (Rule 8-7-2-a).
- III. B1 intercepts a legal forward pass (not a try) deep in his end zone and advances but does not get out of the end zone, where he is downed. During the run, B2 clips A1 in the end zone. **RULING:** Safety, since the penalty leaves the ball in Team B's possession in the end zone.
- IV. B1 intercepts a pass or fumble or catches a scrimmage or free kick between his five-yard line and the goal line, and his momentum carries him into the end zone. The ball remains in the end zone and is declared dead there in Team B's possession. **RULING:** Team B's ball at the spot where the pass or fumble was intercepted, or the kick was caught. The ruling is the same if B1 had recovered a fumble, a backward pass or a kick under similar circumstances.
- V. B1 intercepts a pass or fumble or catches a scrimmage or free kick between his five-yard line and the goal line, and his momentum carries him into the end zone. Before the ball is declared dead, B2 clips in the end zone. B1 does not get out of the end zone, and the ball is declared dead. **RULING:** Safety by penalty. The basic spot is the end of the run where B1 gained



possession between the five-yard line and the goal line, and the foul is behind the basic spot.

- VI. Team A's fumble or backward pass strikes the ground. Team B muffs the ball in an attempt to recover, but it crosses Team A's goal line, where Team A falls on the ball or the ball goes out of bounds from the end zone. **RULING:** Safety. The impetus came from the fumble or pass (Rule 8-7-2-a).
- VII. A36 intends to punt from behind its goal line, but he muffs the ball. After A36 recovers the ball, he runs into the pylon at the intersection of the sideline and goal line. **RULING:** Safety, unless the entire ball is beyond the goal line as the ball carrier contacts the sideline or pylon. The ball is dead at its most forward point when A36 contacts the pylon or sideline (Rules 2-31-3 and 4-2-4-d).
- VIII. B40 intercepts a pass on Team B's four-yard line. His momentum is taking him into the end zone when he fumbles the ball on the one-yard line and (a) B40, the fumbler, recovers the fumble in the end zone, or (b) B45, a teammate of the fumbler, recovers the fumble in the end zone. **RULING:** Safety in both (a) and (b).
- IX. B47 intercepts a pass at the B-3. His momentum carries him into the end zone where he fumbles. The ball rolls into the field of play. A33 recovers at the B-2 but he is hit and fumbles. The ball rolls into the end zone and over the end line. **RULING:** Touchback. Team B's ball, first and 10 at the B-20. The momentum rule applies only if the ball remains in the end zone and is declared dead there. (Rule 8-6-1)
- X. Third and five at the B-20. Defensive back B44 intercepts a forward pass in his end zone. While still in the end zone he fumbles the ball. It rolls forward, goes into the field of play, and in the scramble the ball goes back into the end zone (a) where B44 recovers while grounded; (b) and over the end line. **RULING:** (a) and (b) Safety, two points for Team A. The impetus for the ball going into the end zone the second time is B44's fumble. The scramble to recover the ball does not add new impetus. The momentum rule does not apply because the ball did not remain in the end zone. (Rule 8-7-2)
- XI. 4/Goal @ B-8. Runner A44 is hit at the B-5 and fumbles, and B54 bats the grounded loose ball at the B-3 back into his own end zone. A88 sees the loose ball and recovers while the ball is still in the end zone. **RULING:** Safety, score 2 points for Team A. The bat is a legal bat since B54 is batting the ball backward (Rule 9-4-1-c), but B54 does add a new impetus to the ball and is responsible for the ball's progress into Team B's end zone (Rule 8-7-2-b-1). When A88 recovers the ball, the ball is declared dead based on the 4th down fumble rule (Rule 7-2-2-a Exception 2). The ruling is a safety because the ball becomes dead by rule in the end zone, and B54 is responsible for the ball being there (Rule 8-5-1-a). The safety rule and the 4th down fumble rule would seem to be in conflict here, but the spirit and intent of the safety rule is extremely specific to this play and would supersede the 4th down fumble rule which describes generally how recoveries by Team A on 4th down are handled.

## Section 6. Touchback

### When Declared—ARTICLE 1

#### Approved Ruling 8-6-1

- I. Team A's fumble strikes the pylon at the intersection of Team B's goal line and sideline. **RULING:** Touchback. Team B's ball at the 20-yard line (Rules 7-2-4-c and 4-2-3-b).
- II. B1 intercepts Team A's legal forward pass in his own end zone, after which A1 snatches the ball from his hand while in Team B's end zone. **RULING:** Touchdown. The ball is not automatically dead when intercepted, but it becomes dead when A1 gets possession. However, if in the judgment of the official there is perceptible time during which the Team B player made no attempt to advance after the interception, declaring a touchback is justified.
- III. Third and five at the B-20. Defensive back B44 intercepts a forward pass in his end zone. While still in the end zone he fumbles the ball. It rolls forward, goes into the field of play, and in the scramble A33 kicks the ball into the end zone and over the end line. **RULING:** First and 10 for Team B at the B-30. The result of the play is a touchback, and therefore the basic spot for enforcement of the 10-yard penalty for illegally kicking the ball is the B-20. The touchback results because of the new impetus given by A33 kicking the ball. (Rules 2-16-1-a, 8-7-1, 10-2-2-d-2(a))

## Section 7. Responsibility and Impetus

### Initial Impetus—ARTICLE 2

#### Approved Ruling 8-7-2

- I. Ball carrier A1, advancing toward Team B's goal line, fumbles when B1 bats the ball from his hand or tackles him from the rear. In either case, A1 loses possession short of the goal line, and the ball goes into Team B's end zone, where Team B recovers. **RULING:** Touchback. Impetus is charged to the fumble by Team A (Rule 8-6-1-a).
- II. Any kick by Team A strikes the ground and a Team B player bats the ball across Team B's goal line, where Team B recovers it while grounded or it goes out of bounds. **RULING:** New impetus is given by Team B. Safety, two points for Team A. Batting the kick is considered to have destroyed the impetus of the kick and imparted a new impetus. However, merely touching or deflecting the kick, or being struck by it, does not destroy the impetus of the kick (Rule 8-5-1-a).
- III. Team A punts. The ball is touched by Team B (no impetus added) and crosses Team B's goal line. Then Team B falls on the ball or the ball goes out of bounds from the end zone. **RULING:** Touchback. The same ruling applies if a kick in flight strikes Team B or merely is deflected by an attempted catch. Team B may recover and advance, and it is a touchback if a Team B player is downed in the end zone or goes out of bounds behind the goal line (Rule 8-6-1-a).
- IV. Team A free kicks from its 35-yard line. The ball is rolling on the ground on Team B's three-yard line when B10 kicks the ball into the end zone and over the end line. **RULING:** Safety, due to the new impetus by B10. Team

B foul for illegally kicking the ball. If the penalty (10 yards) is accepted, the down is repeated with the free kick at the A-45. (Rules 9-4-4 and 10-2-2-d-4).

---

# RULE 9

## Conduct of Players and Others Subject to the Rules

---

### Section 1. Personal Fouls

#### Striking Fouls and Tripping—ARTICLE 2

##### Approved Ruling 9-1-2

- I. A player on defense sticks out his foot and trips an opponent. (a) The opponent is a wide receiver running a passing route. (b) The opponent is the ball carrier. **RULING:** (a) and (b) Personal foul, Tripping. Penalty—15 yards, automatic first down.
- II. A1, a ball carrier, strikes tackler B6 with his extended forearm just before being tackled. **RULING:** Personal foul. Penalty—15 yards. Enforce from the previous spot if foul occurs behind the neutral zone. Ejection if flagrant. Safety if the foul occurs behind Team A's goal line.
- III. A11 completes a forward pass to A88 who is tackled in the field of play. During the play defensive end B88 is flagged for a personal foul against A79. **RULING:** The 15-yard penalty is enforced at the spot where A88 is tackled (Rules 7-3-12 and 9-1 Penalty).
- IV. 1/10 @ A-25. Defender B21 is in press coverage, and at the snap strikes wideout A88 in the face mask. A88 is initially disrupted from running the route. A12 is sacked for a 7-yard loss. **RULING:** Personal foul by B21 for striking A88. Team A will have 1/10 @ A-40. With this type action, continuous contact to the opponent's face, helmet (including the face mask) or neck is not a requirement to be a foul as per Rule 9-1-8-a.

#### Targeting and Making Forcible Contact With the Crown of the Helmet—ARTICLE 3

##### Approved Ruling 9-1-3

- I. Passer A12 inside the tackle box is looking for an open receiver. Before or just as he releases the ball, A12 is hit from the side at the ribs, thigh or knee by B79, who dives forward and leads with the crown (top) of his helmet. This occurs in the (a) first half; (b) second half. **RULING:** Foul by B79 for targeting his opponent and initiating contact with the top of his helmet. 15 yards, first down. B79 is automatically disqualified (a) for the remainder of the game. (b) for the remainder of the game and the first half of the next game.
- II. Player number 21 for the home team is disqualified late in the 3rd quarter for targeting with the crown of the helmet. This was number 21's third targeting foul in the season. **RULING:** Enforce the 15-yard penalty for

targeting and number 21 is disqualified. That player may remain in the team area for the balance of the game. If a player receives a 3rd Targeting foul within the same season, in addition to being disqualified for that game, the player will receive a one-game suspension in that team's next scheduled game. While serving this suspension, this player may not be in the team area nor in the playing enclosure. Note: The second half targeting foul may be appealed to the national coordinator for video review.

### Targeting and Making Forcible Contact to Head or Neck Area of a Defenseless Player—ARTICLE 4

#### Approved Ruling 9-1-4

- I. Receiver A83 has just leaped and received a forward pass. As A83 is about to regain his balance, B45 launches and drives into A83 above the shoulder area with his helmet or shoulder. This occurs in the (a) first half; (b) second half. **RULING:** Foul by B45 for targeting and initiating contact with a defenseless opponent above the shoulders. 15 yards, first down. B45 is automatically disqualified (a) for the remainder of the game. (b) for the remainder of the game and the first half of the next game.
- II. As ball carrier A20 sweeps around the end and heads upfield, he lowers his head and contacts defensive end B89 who is trying to tackle him. B89's head is up and the players meet helmet to helmet. **RULING:** No foul. Neither A20 nor B89 is a defenseless player and neither has targeted his opponent in the sense of Rule 9-1-3.
- III. A44 is covering the kickoff that opens the second half. During the return as A44 is running at the Team B 45-yard line, B66 targets and launches into A44 from the side, a blind-side block. B66 first makes contact with his forearm at A44's (a) neck; (b) upper arm or shoulder. **RULING:** (a) Foul by B66 for an illegal blind-side block and targeting a defenseless player by initiating contact at the head or neck area. 15-yard penalty at the end of the run. B66 is disqualified for the remainder of the game and the first half of the next game. (b) Foul for illegal blind-side block. This is not a foul for targeting because the contact by B66 is not to the head or neck area. (Rule 2-27-14)
- IV. A12 who normally plays quarterback is lined up as a wide receiver in the backfield and A33 is five yards behind the snapper in a shotgun formation. A33's pass intended for A12 is intercepted. During the interception return B55 targets and launches at A33, striking him in the side of the helmet. **RULING:** Foul by B55 for targeting and initiating contact at the head of a defenseless player. For purposes of Rule 2-27-14, A33 is a defenseless player since he played the down in the role of the quarterback.
- V. End A81 is split far to the left of the formation, to the outside of defensive end B89. On a sweep play in B89's direction he moves to his left to focus on the ball carrier, losing sight of A81. A81 then cuts to the inside, takes aim and launches at B89, forcibly contacting him with his forearm to B89's neck. **RULING:** Foul for blind-side block with targeting. Under Rule 9-1-4, 15 yard penalty, A81 is disqualified. B89 is a defenseless player as he is subject to the blind-side block. (Rule 2-27-14)
- VI. Ball carrier A33 has gained several yards and is in the grasp of two defenders. A33's forward progress has been stopped and is being driven

back, but the ball has not been declared dead. Linebacker B55 crouches and thrusts himself forward, driving his forearm into the side of A33's helmet. **RULING:** Targeting foul by B55. 15 yard penalty, B55 is disqualified. A33 is a defenseless player since he is in the grasp of the opponents and his forward progress has been stopped. (Rule 2-27-14)

- VII. Pass receiver A88 has just caught the ball when defender B55 launches and drives his shoulder and forearm into his upper body. The back judge flags B55 for targeting to the head-neck area and he is disqualified. The referee makes his announcement of the targeting foul, and the play goes to review. **RULING:** After review, Instant Replay rules that there was not forcible contact to the head-neck area, overturning the disqualification of B55. The referee announces that B55 is not disqualified and that there will be no 15-yard penalty.
- VIII. Punt receiver B44 is in position to catch a punt. Gunner A88 races down the field and launches at B44, driving the side of his helmet and shoulder into B44's upper body the instant before the ball arrives. The side judge and field judge throw their flags and report to the referee that A88 is charged with kick-catch interference and targeting to the head-neck area. The referee makes his announcement of kick-catch interference with targeting to the head-neck area. The play goes to review. **RULING:** After review, Instant Replay rules that A88 did not make forcible contact to the head-neck area, overturning his disqualification. The referee announces that A88 is not disqualified and that the 15-yard penalty for interference with the opportunity to catch a kick will be enforced.
- IX. In a game without instant replay, the conference or teams have agreed to use the halftime review process for first-half targeting fouls. During the first quarter, pass receiver A88 has just caught the ball when defender B55 launches and drives his shoulder and forearm into his upper body. The back judge flags B55 for targeting to the head-neck area. The referee makes his announcement of the targeting foul and that B55 is disqualified. **RULING:** In the halftime review of the video, the referee and the crew determine that B55 did not make forcible contact to A88's head-neck area, overturning his disqualification. The referee informs both head coaches that B55 may return to the game in the second half. Before the kickoff for the second half, the referee announces to the stadium that after review, the disqualification of B55 is overturned and he may return to the game for the second half.
- X. On a punt return, B44 launches at A66 from the blind side and drives his shoulder into him. The force of the contact is at A66's side below the shoulder. **RULING:** Foul for blind-side block. A66 is a defenseless player because B44 executes a blind-side block. However, this is not a targeting foul because the forcible contact is not to the head/neck area.

## Blocking Below the Waist—ARTICLE 6

### Approved Ruling 9-1-6

- I. 1/10 @ A-40. Back A44 is lined up just behind the RT, and has his left foot inside the RT's outside foot. At the snap, A44 works back across the formation and blocks B77 below the waist from the side. B77 is inside the tackle box and 1 yard in the offensive backfield at the time of the block.

During the play, A33 runs for a 12-yard gain. **RULING:** The block by A44 is an illegal block below the waist because it is not directed from the front. Stationary backs lined up within the tackle box may block below the waist in the tackle box until the ball leaves the tackle box only if the force of the initial contact is directed from the front. The penalty is 15 yards and is enforced from the previous spot. Team A will have 1/25 @ A-25.

- II. 1/10 @ A-40. Back A44 is stationary and lined up 4 yards deep and is just behind the RG. After the snap, QB A12 takes a deep drop, and remains in the tackle box looking downfield. Linebacker, B55 blitzes between the LG and LT, and A44 crosses over to the left side of the formation and blocks B55 below the waist at the A-36. The block is directed from the front. After the block, A12's pass is completed to A88 for a gain of 15-yards. **RULING:** There is no foul on the play. The block by back A44 is legal as a stationary back lined up within the tackle box may block below the waist in the tackle box until the ball leaves the tackle box only if the force of the initial contact is directed from the front. Team A will have 1/10 @ B-45.
- III. Back A41 is stationary at the snap directly behind the right tackle in a balanced line formation. His left shoulder is inside the tackle box. The quarterback hands the ball to back A22 who runs straight ahead. A41 blocks B2 who moves into the offensive backfield to make a play on the ball carrier before A22 reaches the line of scrimmage. The block is below the waist and clearly at the side. **RULING:** Illegal block. A41 is partially inside the tackle box and behind the second lineman at the snap, but the block is not from the front.
- IV. Defensive end B88 is lined up on the outside shoulder of tackle of A75. On the initial line charge, B88 blocks tackle A75 below the waist from the side inside the tackle box. **RULING:** No foul for an illegal block below the waist.
- V. Back A22 is stationary inside the tackle box at the snap. After the snap A22 shoots between the tackle and the guard and blocks B55 below the waist directed from the front. The initial contact is three yards beyond the neutral zone. **RULING:** Illegal block below the waist. The block is directed from the front, but is beyond the neutral zone.
- VI. 3/7 @ A-30. The ball is at the left hash mark. Back A22 is split completely outside the frame of the tackle on the left side, and B40 moves out to cover him. The handoff goes to back A44 who sweeps around the right end. As the play develops B40 follows the play and A22 chases him. At the A-34 beyond the right hash mark A22 overtakes B40 and blocks him below the waist clearly and directly at the front ("10-to-2"). A44 is tackled at the B-45. **RULING:** Illegal block below the waist. A22's initial position is outside the tackle box, so A22 may not legally block below the waist.
- VII. 1/10 @ A-40. A12 takes the snap and starts on a sweep to his right. Guard A66 pulls and leads the play. As the play develops linebacker B55 blocks A66 from the front at the thigh at the A-39. A12 is driven out of bounds at the A-48. **RULING:** Illegal block below the waist. B55 was not aligned in a stationary position within one yard of the line of scrimmage and therefore cannot block below the waist.

- VIII. At the snap tight end A85 is aligned six yards from the snapper. Before the ball has left the tackle box, A85 blocks tackle B77 below the waist at the side. **RULING:** Illegal block below the waist. A85's initial position is outside the tackle box at the snap, so A85 may not block below the waist. Fifteen-yard penalty.
- IX. 1/10 @ A-45. Guard A66 is next to the snapper. Immediately after the snap, A66 blocks (a) nose guard B55 at the A-46, or (b) linebacker B33 at the A-48. In either case the block is below the waist at the side of the opponent. **RULING:** (a) Legal block. A66 has left the tackle box, but a block initiated one yard beyond the neutral zone is considered within the tackle box. (b) Foul, illegal block below the waist. In this case, A66 has left the tackle box and has gone to the second level to make this low block. To be legal this block may not be below the waist.

### Late Hit, Action Out of Bounds—ARTICLE 7

#### Approved Ruling 9-1-7

- I. After the ball is dead, a player throws himself onto an opponent lying on the ground. **RULING:** Personal foul. Penalty—15 yards from the succeeding spot and first down if by a Team B player and not in conflict with other rules. "Piling on" applies to a ball carrier or to any other opponent who is prostrate when the ball becomes dead.
- II. On a sweep play toward the sideline, linebacker B55 goes out of bounds to avoid a block. Guard A66 is leading the play, and just as he steps on the sideline with his front foot he drives his shoulder in the waist at the front of B55 who is still out of bounds. **RULING:** Legal block. A66 does not have both feet out of bounds.

### Roughing the Passer—ARTICLE 9

#### Approved Ruling 9-1-9

- I. After passer A17 releases the ball, B68 takes two strides and charges into A17, showing no attempt to avoid contact. **RULING:** Roughing the passer. The passer is a defenseless player who is vulnerable to injury and must be fully protected. After taking two strides, B68 should be aware that A17 has released the ball and be able to avoid contacting him.
- II. Quarterback A11 drops back in the pocket and sets up to pass. Just as he releases the ball he is hit by end B88 who drives his shoulder into A11's knee. The pass is (a) incomplete; (b) caught by A44 who is tackled after a 12-yard gain to the B-40. **RULING:** Foul by B88 for forcibly hitting the passer at the knee or below, in violation of Rule 9-1-9-b. Automatic first down and 15-yard penalty enforced at (a) the previous spot; (b) at the B-40, the end of the run by A44.
- III. Quarterback A11 drops back in the pocket and sets up to pass. He then scrambles to his right, sets up again and is in the passing posture when he is hit by end B88 who drives his shoulder into A11's knee. A11 then pulls the ball in and goes to the ground because of being tackled by B88. **RULING:** Foul by B88, violation of Rule 9-1-9-b. While A11 is technically not a passer because he did not release the ball, the action by B88 is a foul under 9-1-9-b because of the vulnerability of A11 as a potential passer in a passing posture.



**Chop Blocking—ARTICLE 10****Approved Ruling 9-1-10**

- I. On a forward pass play, A75 is blocking B66 at the waist behind the neutral zone. While A75 maintains contact, A47 subsequently blocks B66 at his thigh. **RULING:** Chop block, 15 yards from the previous spot.
- II. As the flow of the play moves to the left, right tackle A77 is disengaging from his block above the thigh with B50 when A27 blocks B50 at his knee. **RULING:** Chop block, 15 yards. Previous-spot enforcement if the foul occurs behind the neutral zone.
- III. Immediately after the snap, left guard A65 and left tackle A79 simultaneously block B66, who is in the neutral zone. (a) Both blocks are at the thigh. (b) One contact is at the waist and the other at the knee. **RULING:** (a) Legal blocks for a low-low combination. (b) Foul, chop block.
- IV. Tight end A87 and wingback A43 are leading the play when both simultaneously block linebacker B17, who is three yards beyond the neutral zone. (a) Both blocks are above the waist. (b) One block is above the waist and the other at the knee. **RULING:** (a) Legal blocks. (b) Foul, chop block.
- V. After snapping the ball, snapper A54 brushes by nose guard B62 on his way to block a linebacker. A54 makes slight contact with B62, or B62 reaches out and uses his arm to initiate contact with A54. While B62 and A54 are in contact, right guard A68 blocks B62 at the knee from the front. **RULING:** Legal. A54 is not blocking B62. The incidental contact or B62's initiating contact does not constitute part of a combination block, and hence there is no chop block.

**Contact Against the Snapper—ARTICLE 14****Approved Ruling 9-1-14**

- I. A10 is in a shotgun-type formation 7-1/2 yards behind the snapper, who has his head down and is looking backward through his legs. Immediately after the snap, nose guard B55 charges directly at the snapper and contacts him by pushing him backward. **RULING:** Legal. The snapper is not afforded any special protection because Team A is not in a scrimmage kick formation, since A10 is not at least 10 yards deep (Rule 2-16-10). The snapper does have the usual protection against any personal foul for unnecessary roughness.
- II. Team A is in a scrimmage kick formation with the punter 15 yards behind the line of scrimmage. Immediately after the snap, nose guard B55 charges directly at the snapper, contacts him, and drives him backward. The ball is snapped to an upback three yards behind the scrimmage line or to the potential kicker, who instead runs with or passes the ball. **RULING:** Foul. Penalty—15 yards and automatic first down. The snapper may not be contacted until one second has elapsed after the snap when Team A is in a scrimmage kick formation.
- III. Immediately after the snap, with Team A in a scrimmage kick formation, B71 is lined up within one yard of the line of scrimmage and is outside of the frame of the snapper. B71 attempts to “shoot the gap” between the snapper and the adjacent lineman. B71's initial legal contact is with the

lineman next to the snapper. **RULING:** Legal. Incidental contact with the snapper after this initial legal contact is not a foul (Rule 2-16-10).

### **Horse Collar Tackle—ARTICLE 15**

#### **Approved Ruling 9-1-15**

- I. As ball carrier A20 races down field near the sideline, defender B56 grabs him from behind by the back of the jersey at the collar or by the collar of his shoulder pad. B56 continues with this contact for several yards but A20 does not go to the ground until tackled by another defender. **RULING:** Legal play. B56 did not foul because he did not abruptly pull A20 down.

### **Roughing or Running Into Kicker or Holder—ARTICLE 16**

#### **Approved Ruling 9-1-16**

- I. A1 catches a long snap and plans to punt from behind his line of scrimmage but misses the ball, which falls to the ground. A1 is then contacted by B1. **RULING:** Team A fumble. No foul by B1. There is no kicker until the ball is kicked.
- II. A1 kicks the ball, after which B1, unable to stop his attempt to block the kick, makes contact with the kicker or holder. **RULING:** This action could be either “Roughing” or “Running into” the kicker or holder. When in question, the ruling is to be “roughing,” which carries a penalty of 15 yards and an automatic first down.
- III. A1, from a nonscrimmage kick formation, makes a quick, unexpected kick so suddenly that B1 cannot avoid contact. **RULING:** This is not roughing or running into the kicker since the rule applies only when it is obvious that a kick will be made.
- IV. B1 runs into player A1, who has kicked the ball and has had a reasonable time to regain his balance. **RULING:** Not a foul by B1 unless ruled as running into or throwing himself against an opponent obviously out of the play (Rule 9-1-12).
- V. After B1 runs into the kicker, kicker A25 simulates being roughed. **RULING:** Offsetting fouls.
- VI. Team A is in a scrimmage kick formation. Punter A1 moves laterally two or three steps to recover a faulty snap, or recovers a snap that went over his head, and then kicks the ball. B2 contacts A1 in an unsuccessful attempt to block the kick. **RULING:** A1 does not automatically lose his protection in either case unless he carries or possesses the ball outside the tackle box. While in the tackle box A1 is entitled to protection as in any other kicking situation. When it becomes obvious that A1 intends to kick in a normal punting position, defensive players must avoid him after he kicks the ball.
- VII. Punter A22 is 15 yards behind the neutral zone when he catches the long snap, sprints to his right at an angle toward the line of scrimmage, and runs outside the tackle box. He then stops and punts the ball, and (a) is immediately hit by a diving B89; or (b) is immediately hit by B89, and B89 is guilty of targeting. **RULING:** (a) Legal play, no foul by B89. A22 loses his roughing or running-into protection by carrying the ball outside the tackle box. (b) Even though the kicker is outside the tackle box, targeting is a personal foul and the penalty will be enforced at the previous spot.

**Continued Participation Without Helmet—ARTICLE 17****Approved Ruling 9-1-17**

- I. During a down B55's helmet comes off without a helmet foul by Team A. B55 immediately picks up his helmet, puts it on and continues to chase the ball carrier. **RULING:** Personal foul by B55 for continuing to participate after losing his helmet. The clock stops at the end of the down and B55 must leave the game for the next down. (Rule 3-3-9)

**Blind-Side Block—ARTICLE 18****Approved Ruling 9-1-18**

- I. B44 intercepts the pass of A12 at the B-20 and turns back up-field on the return. During the return, B21 approaches A88 at midfield from the blind side and blocks A88 (a) with extended hands; (b) with a screen type block; (c) by attacking with forcible contact with his shoulder into the chest of A88; (d) by attacking with forcible contact with the shoulder into the head of A88. B44 returns the pass to the A-20. **RULING:** (a) No foul. (b) No foul. (c) Personal Foul, blind-side block, 15-yard penalty from the spot of the foul. (d) Personal Foul, Blind-Side Block with Targeting, 15-yard penalty from the spot of the foul and B21 is disqualified.

**Section 2. Unsportsmanlike Conduct Fouls****Unsportsmanlike Acts—ARTICLE 1****Approved Ruling 9-2-1**

- I. Team B scores a touchdown on a kickoff return, and substitutes from the Team B area, with no intention of entering the game, run to the end zone to congratulate the ball carrier. **RULING:** Unsportsmanlike act. Penalty—15 yards, enforced on the try, the succeeding kickoff or from the succeeding spot in extra periods. Officials should note the numbers of the offending players, for possible ejection later in the game upon committing a second unsportsmanlike conduct foul (9-2-1-a-Penalty).
- II. Third and 15 at the B-20. Eligible A88 catches a pass at the B-18 and heads for the goal line. At the B-10 he goes into a “goose step” and continues this action as he crosses the goal line. **RULING:** Live-ball foul for unsportsmanlike conduct. Fifteen-yard penalty enforced at the spot of the foul, which is the B-10, and repeat third down. Third and 20 at the B-25.
- III. Second and 5 at the B-40. Back A22 takes a backward pass from the quarterback, circles right end, and heads for the goal line. Guard A66, who had pulled out to lead the play, legally blocks B90 to the ground and then stands over him at the B-30 taunting and screaming obscenities. This draws a flag from the head linesman, when A22 is at the B-10 before continuing into the end zone. **RULING:** Live-ball foul for unsportsmanlike conduct. Fifteen-yard penalty enforced at the spot of the foul, which is the B-30, and repeat second down. Second and 10 at the B-45.
- IV. Third and 15 at the B-20. Eligible A88 catches a pass at the B-18 and heads for the goal line. Very close to the goal line he dives into the end zone, with no Team B player closer than about 10 yards. The field judge is

uncertain of the exact spot where A88 started his diving action. **RULING:** Foul for unsportsmanlike conduct. Administer as a dead-ball foul: The touchdown counts and the penalty is enforced on the try, the succeeding kickoff, or from the succeeding spot in extra periods.

- V. Second and seven at the B-30. Nose guard B55 is lined up in the neutral zone at the snap. Back A22 takes the ball on a quick play up the middle, bursts into the open, and at the B-10 he turns around prances backward into the end zone. The head linesman and the line judge both have flags for the offside foul, and the back judge drops his flag for the action by A22. **RULING:** Offsetting fouls, repeat the down. Second and seven at the B-30.
- VI. First and 10 at the 50. The quarterback pitches out to running back A44 who circles right end and races toward the goal line. The line judge trailing the play flags linebacker B57 for screaming obscenities at him, complaining that he was held by the tight end. A44 scores a touchdown. **RULING:** Live-ball unsportsmanlike conduct against B57. The penalty carries over to either the try or the kickoff, at the option of Team A.
- VII. Third and 15 at the A-45. A12 drops back to pass and is sacked by tackle B77 for a 10-yard loss. B77 leaps to his feet, beats his chest, stands over A12 and taunts him, and showboats to the crowd, drawing flags from the referee and the line judge. **RULING:** Dead-ball unsportsmanlike conduct by B77. Fifteen-yard penalty at the dead-ball spot plus automatic first down. First and 10 for Team A at the 50.
- VIII. Safety B33 intercepts a pass at the B-10 and returns for a touchdown. As he is coming down the sideline covering the play the line judge drops his flag after he runs into the Team B head coach who is just on the field of play near the B-40. **RULING:** Although this is a foul that takes place while the ball is alive, it is treated as a dead-ball foul against the team because it is committed by a non-player. The touchdown counts and the 15-yard penalty is enforced on the try, the succeeding kickoff, or from the succeeding spot in extra periods.
- IX. Second and five at the A-45. Ball carrier A33 breaks out into the open and has a clear path to the goal line. At the B-2 he suddenly makes a sharp left turn and trots along the B-2 as the Team B players begin to catch up to him. He then carries the ball into the end zone. A33 next runs to the stands and begins to exchange “high-fives” with the fans. **RULING:** No score. A33 is charged with two fouls for unsportsmanlike conduct, one live-ball and the other dead-ball. Both 15-yard penalties are enforced and A33 is ejected from the game. First and 10 for Team A at the B-32. (Rule 9-2-6)
- X. After the ball carrier is tackled, A55 and B73 engage in a scuffle such that officials have to separate them and throw flags. Both A55 and B73 are charged with dead-ball personal fouls. **RULING:** Offsetting dead-ball fouls. Each player is also charged with an unsportsmanlike conduct foul which counts toward the two such fouls leading to automatic ejection. The referee announces either the first or second unsportsmanlike conduct foul for A55 and B73.

- XI. During the play, the ball carrier fumbles and several players dive for the ball. B55 grabs A33 and slings him off the pile. **RULING:** B55 is charged with a foul for unsportsmanlike conduct. 15 yards and automatic first down. The referee announces that this is either the first or second unsportsmanlike conduct foul against B55. If it is the second, B55 is ejected from the game.
- XII. During a dead-ball time, a head coach or an assistant coach is flagged for coming out to the numbers and cursing the officials in a loud and abusive manner. **RULING:** The officials charge either the head coach or the assistant coach with a foul for unsportsmanlike conduct. The referee announces that this is either the first or second unsportsmanlike conduct foul against the coach in question. If it is the second, the coach in question is ejected from the game.

### Unfair Tactics—ARTICLE 2

#### Approved Ruling 9-2-2

- I. After the ball is ready for play, Team A goes into a formation with two players split wide on both sides of the snapper and two other Team A linemen adjacent to the snapper. No more than four players are legally in the backfield. Team A sends in two substitutes, who take positions on the line of scrimmage adjacent to the two split offensive linemen on the opposite side of the field of play from their team bench. This leaves Team A with nine players on the line of scrimmage and four backfield players all legally in position. Immediately and before the snap, two Team A linemen nearest their team's bench leave the field of play and are off at the snap. Seven players are on the line of scrimmage, five of whom are Team A linemen numbered 50 to 79. **RULING:** Penalty—15 yards from the previous spot. This is a simulated replacement of a player to confuse the opponents.
- II. On fourth down at Team B's 12-yard line, A1 enters the field of play with a kicking shoe while his 11 teammates are in the huddle. A1 kneels and measures the distance from the neutral zone to the kicking spot. While his teammates are leaving the huddle, A1 leaves the field of play with the shoe. Team A quickly runs a play from scrimmage. **RULING:** Team A foul for unsportsmanlike conduct. Penalty—15 yards from the previous spot. There shall be no simulated replacement of a player to confuse the opponents, and a player who communicates must remain in the game for one down.
- III. A1 leaves the field of play during a down. Team A huddles with 10 players. Substitute A12 enters, and A2 simulates leaving the field but sets near the sideline for a "hide-out" pass. **RULING:** Penalty—15 yards from the previous spot. This is a simulated replacement of a player to confuse opponents.
- IV. While a team is legally set to attempt a field goal, the potential holder for the kick goes toward his team area asking for a shoe. A shoe is thrown on the field and the player, in motion toward his team area, turns toward the goal line. The ball is snapped to the player in the kicking position, who throws a pass to the player who had turned up field after asking for a shoe. **RULING:** Penalty—15 yards from the previous spot.
- V. Team A is lined up in scrimmage kick formation and has been set for one second. One of the offensive backs shouts to and motions to A40,

the blocker on the right wing, to get off the field. At the snap, A40 is in legal motion toward his sideline. A40 turns downfield and becomes a pass receiver. **RULING:** Penalty—15 yards from the previous spot. This is a tactic associated with the substitution process to deceive opponents.

- VI. After the down is over, Team A sends in three substitutes, and three players begin to leave the field. A88, who participated in the previous play, trails the three replaced players toward the Team A sideline. The three replaced players continue into the team area, but A88 stops and sets up on the line of scrimmage very close to the sideline. After the ball is snapped A88 runs down the sideline and catches a forward pass. **RULING:** Team A foul at the snap, unsportsmanlike conduct for unfair tactics: using the substitution process to deceive the opponents. Live-ball foul. Penalty: 15 yards at the previous spot.
- VII. 4/10 @ A-35. As Team A begins substitutions for a potential punt, it is discovered that Team A has assigned three players wearing the number 2. **RULING:** Unsportsmanlike Conduct charged against the head coach. After enforcement, 4/25 @ A-20. This counts toward the two Unsportsmanlike Conduct fouls that leads to automatic ejection.
- VIII. 4/1 @ B-40. QB A12 moves from shotgun formation to under center and barks signals in an unsuccessful attempt to draw Team B offside. With 10 seconds remaining on the play clock, A12 backs away from the center and jogs toward the sideline being very demonstrative with his arms and waiving to the bench. As A12 approaches the sideline, the ball is snapped directly to back A44 just before the play clock expires and A44 runs to the B-38. **RULING:** A, 4/16 @ A-45 - Unsportsmanlike Conduct by A12, penalize Team A 15 yards from the previous spot. The action by A12 is in violation of the spirit of Rule 9-2-2-b.

### Unfair Acts—ARTICLE 3

#### Approved Ruling 9-2-3

- I. After the ball is ready for play and the umpire (or center judge) is in his regular position, Team A quickly replaces some players with substitutes, gets set for the required one second and snaps the ball. The umpire (or center judge) is attempting to get to the ball to allow the defense to match up, but he is unable to prevent the snap. **RULING:** The play is shut down, the game clock is stopped and the defense is allowed to substitute in response to Team A's late substitutions. No foul. The play clock is set to 25 seconds and starts on the ready-for-play signal. The game clock starts on the ready-for-play signal or the snap, depending on its condition when play was stopped. The referee informs the Team A head coach that any subsequent such actions will result in a foul against the team for unsportsmanlike conduct. (Rule 3-5-2)
- II. Team A, trailing by nine points, has 1st-and-10 on the B-22 with 0:35 showing on the game clock. At the snap, B21, B40 and B44 blatantly hold, wrapping both arms around Team A's wideouts and take them to the ground. Quarterback A12 has no receiver in the route, scrambles and then legally throws the ball away. After the play, the game clock reads 0:26. The back judge, field judge and side judge have a flag down for Team B holding on each of their keys. **RULING:** This is a blatant and obvious unfair act

designed to take time off the clock. The referee will convert the holding fouls to an unsportsmanlike conduct fouls. Penalize half the distance to the goal. Team A will have 1st and 10 at the B-11. The game clock is reset to 0:35 and starts on the next snap. B21, B40 and B44 each have one unsportsmanlike foul counter.

- III. Team A, ahead in the score by four points, has 4th-and-10 at the A-30 with 0:14 seconds remaining in the game. From a shotgun formation, A12 receives the snap, retreats back toward his own goal line, and moves out of the tackle box. At the snap, each Team A lineman blatantly holds the Team B player in front of them, preventing the defensive linemen from immediately rushing the passer. When rushers approach A12 he throws the ball high so that it lands beyond the line of scrimmage and out of bounds. When the pass hits the ground, the game clock reads 0:00. The umpire, center judge (if applicable) and referee each have a flag on the ground for holding on Team A. **RULING:** This is a blatant and obvious unfair act designed to take time off of the clock. The referee will convert the holding fouls to unsportsmanlike conduct fouls. Penalize Team A 15 yards from the previous spot. Team A will have 4th and 25 at the A-15. The game clock is reset to 0:14 and starts on the next snap. Each Team A lineman guilty of holding will have one unsportsmanlike foul counter.
- IV. 1/10 @ A-25 with 0:01 remaining in the game and Team A trails by 5 points. A12 throws a pass that is complete to A88 at midfield. After the catch by A88, there are a series of legal backwards passes keeping the ball alive in Team A possession. Eventually A21 laterals the ball toward teammate A44, and the ball hits the ground with no recovery. The Team B bench thinking that the ball is dead rushes the field and many squad members are on the field. A44 recovers the ball and begins running and encounters heavy traffic with the Team B squad members on the field, reverses field and is finally tackled by B50 at the B-30. **RULING:** No substitute, coach or any person subject to the rules, other than a player or official may interfere in any way with the ball or a player while the ball is in play. This unfair act will be penalized 15 yards as a live ball foul. The Referee may enforce any penalty that they consider equitable, including awarding a score.

## Game Administration and Sideline Interference—ARTICLE 5

### Approved Ruling 9-2-5

- I. On the opening kickoff, B22 catches the kick at his goal line and returns the ball down the sideline on Team B's side of the field. As he moves down the sideline officiating the play, the side judge either runs into or must run around a Team B coach or squad member in the restricted area ("the white"). B22 is driven out of bounds at the A-20. **RULING:** Either situation is physical interference with an official during the play. No warning. Team B foul for unsportsmanlike conduct administered as a dead-ball foul. After the 15-yard penalty, Team B will have first and 10 at the A-35.
- II. During a long kickoff return, the Side Judge has to stop and run around the head coach who is out of the coaching box in the restricted area or on the field of play near the sideline. **RULING:** Team foul for unsportsmanlike



conduct. Administer as a dead-ball foul. Penalize 15 yards at the succeeding spot. This is a team foul, and is not charged as an unsportsmanlike conduct foul against the head coach.

- III. During a long kickoff return, the head coach and/or other coaches are outside the coaching box and are in the restricted area or on the field of play near the sideline. No physical interference is made with an official during the play. **RULING:** Administer as a dead-ball foul.

*First infraction:* Warning for sideline interference. No yardage penalty.

*Second and third infractions:* Delay of game for sideline interference, five yards from the succeeding spot.

*Fourth and subsequent infractions:* Team unsportsmanlike conduct foul for sideline interference. Penalize 15 yards at the succeeding spot. This is a team foul, and is not charged as an unsportsmanlike conduct foul against any coach.

### **Ejected Players and Coaches—ARTICLE 6**

#### **Approved Ruling 9-2-6**

- I. During a long kickoff return, the head coach of the kicking team comes onto the field of play, vigorously and angrily protesting that there should have been a flag for holding by the receiving team during the return. **RULING:** Unsportsmanlike conduct foul against the head coach. Administer as a dead-ball foul. Penalize 15 yards at the succeeding spot. This counts as one of the unsportsmanlike conduct fouls against the head coach. If this were his second foul for unsportsmanlike conduct, the head coach would be ejected from the game. A head coach ejected from the game may designate a new head coach.

## **Section 3. Blocking, Use of Hand and Arm**

### **Interfering for or Helping the Ball Carrier or Passer—ARTICLE 2**

#### **Approved Ruling 9-3-2**

- I. In trying to gain yardage, ball carrier A44 is slowed by defensive players attempting to make the tackle. Back A22 (a) puts his hands on the buttocks of A44 and pushes him forward; (b) pushes the pile of teammates who begin to surround A44; (c) grabs the arm of A44 and tries to pull him forward for more yardage. **RULING:** (a) and (b) Legal. It is not a foul to push the ball carrier or the pile. (c) Foul for assisting the runner. Five-yard penalty with three-and-one enforcement. (Rule 9-3-2-b)

### **Holding and Use of Hands or Arms: Offense—ARTICLE 3**

#### **Approved Ruling 9-3-3**

- I. A6 is advancing the ball. During the run, A12 vigorously blocks B2 with a rough push in the back above the waist. **RULING:** Illegal block in the back. Penalty—10 yards.
- II. A teammate of the passer or ball carrier, while charging across the neutral zone, contacts an opponent with his hands and arms not parallel to the ground or his hands cupped or closed but with the palms not facing the opponent. **RULING:** Legal use of hands.



- III. A teammate of the passer or ball carrier, behind the neutral zone, has his arms parallel to the ground and contacts an opponent above the shoulders. **RULING:** Illegal use of hands. Penalty—10 yards or 15 yards for personal foul, previous-spot enforcement. Safety if the foul occurs behind Team A's goal line.
- IV. A teammate of the passer or ball carrier delivers a blow with the hand(s) closed to an opponent below the shoulders. **RULING:** Personal foul. Penalty—15 yards. Enforce at the previous spot if foul occurs behind the neutral zone. Safety if the foul occurs behind Team A's goal line.
- V. A2's hands contact defensive player B2 in a legal block. B2 spins to avoid blocker A2, whose hands then contact B2's back. **RULING:** Legal block.
- VI. A2's hands contact defensive player B2's back when B2 spins to avoid A2. A2 keeps his hands on B2's back while B2 advances toward the passer. **RULING:** Legal block.
- VII. A2's hands contact defensive player B2 when B2 spins to avoid blocker A2, whose hands then contact B2's back. After A2's hands lose contact with B2, A2 advances and pushes B2 in the back. **RULING:** Illegal block in the back. Penalty—10 yards. Enforce at the previous spot if foul occurs behind the neutral zone (Rule 2-3-4). Safety if the foul occurs behind Team A's goal line.
- VIII. A1 in, beyond or behind the neutral zone contacts an opponent with an open hand or with hands closed or cupped and palms not facing the opponent. **RULING:** Legal block.
- IX. A12 takes the snap and retreats to pass. Defensive end B95 gets past A75 and is about to tackle A12, who is still inside the tackle box. A75 pushes B95 in the back at the numbers to prevent him from making the tackle. A12's pass is complete for a touchdown. **RULING:** Touchdown counts. No foul by A75. Such continuing action involving pass protection while the passer remains inside the tackle box are within the spirit of the exception to Rule 9-3-6 and are thus legal. However, if this is a totally separate action and a new block outside the blocking zone, it is a foul for a block in the back.

### **Use of Hands or Arms by Defense: Passing Downs—ARTICLE 4**

#### **Approved Ruling 9-3-4**

- I. Before a legal forward pass that crosses the neutral zone is thrown, Team B holds eligible A1, who is beyond the neutral zone. **RULING:** Team B foul, holding. Penalty—10 yards and automatic first down, previous-spot enforcement.
- II. 3/15 @ B-45. QB A12 drops back and looks downfield for A88 who is the primary receiver and defender B21 is holding A88 at the B-35. A12 throws a forward pass to his checkdown receiver A44 but the ball falls incomplete at the B-46. **RULING:** A, 1/10, B-35, Snap. The penalty for B21's holding foul is enforced 10 yards from the previous spot and an automatic 1st down. Holding by defense carries an automatic first down.

## Section 4. Batting and Kicking

### Batting a Loose Ball—ARTICLE 1

#### Approved Ruling 9-4-1

- I. Team A attempts a field goal from Team B's 30-yard line. A Team B player in the end zone leaps above the crossbar and bats the ball in flight. The ball goes into the end zone and is recovered by Team A. **RULING:** Foul for batting the ball in the end zone. The result of the play is a touchdown.
- II. Team A attempts a field goal from Team B's 30-yard line. A Team B player in the end zone leaps above the crossbar and bats the ball in flight. The ball goes into the end zone and is recovered by Team B. **RULING:** Foul for batting the ball in the end zone. The result of the play is a touchback. Safety if penalty is accepted.
- III. Team A attempts a field goal from Team B's 30-yard line. A Team B player in the end zone leaps above the crossbar and bats the ball in flight. The ball goes into the field of play. **RULING:** Foul for batting the ball in the end zone. During regulation play, postscrimmage kick enforcement gives a safety by penalty. The ball remains alive, and normal scrimmage kick rules apply. Team A may elect the result of the play. If Team A recovers, does not score and accepts the penalty, or if the play occurs in an extra period, enforcement is at the previous spot.
- IV. Team A attempts a place kick on the try. A Team B player in the end zone leaps above the crossbar and bats the ball in flight. The ball goes out of bounds in the end zone. **RULING:** Foul for batting the ball in the end zone. Penalty—Half the distance from the previous spot. Postscrimmage kick rules do not apply on the try (Rule 10-2-3).
- V. Team A attempts a place kick on the try. A Team B player in the end zone leaps above the crossbar and bats the ball in flight. The ball goes into the end zone and is recovered by Team A. **RULING:** Foul for batting the ball in the end zone. Team A may decline the penalty and scores two points.
- VI. Team A attempts a field goal, and B23, in the end zone, goes above the crossbar and catches the ball. **RULING:** Legal play.
- VII. Team A's fumble in flight is batted forward by B1, and the ball goes out of bounds behind Team A's goal line. **RULING:** Safety. Batting a fumble in flight does not add a new impetus (Rule 8-7-2-b). Team B foul. Penalty—10 yards.
- VIII. Team A's backward pass in flight is batted by B1, and the ball goes out of bounds behind Team A's goal line. **RULING:** Safety. A pass may be batted in any direction and the impetus is charged to Team A's pass (Rule 8-5-1-a).
- IX. A free kick is muffed in flight by a Team B player in his end zone. While the ball is loose in the end zone, a Team B player bats the ball out of the end zone. **RULING:** The result of the play is a touchback. Team B foul for illegally batting a ball in the end zone. Penalty—10 yards from the previous spot.
- X. After intercepting a legal forward pass at the B-20, B1 fumbles at the B-38. At the B-30, B2 illegally bats the loose ball, which goes forward and out of bounds. **RULING:** Team B foul. Penalty—10 yards from the spot of the foul. Team B's ball, first and 10 at the 20-yard line. No loss of down

is included in the penalty since Team B is awarded a new series after the penalty enforcement (Rule 5-1-1-e-1).

- XI. Team A is prepared to kick off. The ball is on the tee and the referee has signaled it ready for play. As the kicker approaches the ball it begins to roll off the tee just as he starts his kicking motion. The kicker follows through and kicks the ball as it continues to roll off or near the tee. **RULING:** No foul. This is not a violation of either 9-4-4 or 9-2-1-a-2-a. The officials should stop play and have the teams line up for a new kickoff. If weather conditions dictate, Team A should have a player hold the ball on the tee.

### **Illegally Kicking Ball—ARTICLE 4**

#### **Approved Ruling 9-4-4**

- I. 4/8 @ A-48. From a scrimmage kick formation, A32 punts the ball to the B-7 where it hits B25 on the leg. As the ball rolls along the ground, B25 then kicks it at the B-4 to prevent Team A from recovering. The ball bounces into Team B's end zone and over the end line. **RULING:** The result of the play is a safety, as B25's kicking the ball provides new impetus. Foul by B25 for illegally kicking the ball. Team A may decline the penalty and take the two points, or accept the penalty. The foul by B25 is governed by postscrimmage kick rules, so the accepted penalty would give Team B the ball at the B-2, first down and 10. (Rules 8-5-1-a and 8-7-2-b)

---

# RULE 10

## Penalty Enforcement

---

### Section 1. Penalties Completed

#### Offsetting Fouls—ARTICLE 4

##### Approved Ruling 10-1-4

- I. On a Team A kickoff, Team B fouls before the untouched ball goes out of bounds between the goal lines. **RULING:** Offsetting fouls. Team A re-kicks at the previous spot.
- II. On a Team A kickoff from its 35-yard line, Team B fouls after the untouched ball goes out of bounds between the goal lines. **RULING:** Team B may elect a replay with Team A free-kicking at its 45-yard line. If Team B retains the ball, it will be at its 20-yard line, after the 15-yard penalty from its 35-yard line, or 15 yards behind the spot where the five-yard penalty against Team A left the ball (Rules 6-1-8 and 10-1-6).
- III. Team A is an illegal formation at the snap. A1's forward pass is intercepted by B1, who advances five yards and is tackled. Team B clips during B1's run. **RULING:** Team B has the option to accept offsetting fouls and repeat the down or to decline offsetting fouls and retain the ball after its penalty is completed. In the latter case Team A may accept or decline the penalty for Team B's clipping foul.
- IV. A1 throws an illegal forward pass and Team B is in the neutral zone at the snap. B23 intercepts the pass and B10 clips on the return. B23 is tackled in the field of play. **RULING:** No option. The fouls offset and the down is replayed. Team B may not decline offsetting fouls because it had fouled before getting possession of the ball.
- V. A1's forward pass is intercepted by B1, who advances and fumbles. B2 recovers and returns the ball five more yards. Team A fouls during or after the down, and Team B fouls during the fumble or during return by B2. **RULING:** If Team A's foul was a live-ball foul, Team B may select offsetting fouls and replay the down or select an option to retain the ball following the completion of the penalty for its foul. If Team A's foul was a dead-ball foul, Team B retains the ball after enforcement of both penalties.
- VI. Team A's legal forward pass is intercepted by B45, who advances several yards. On the return, B23 clips and A78 tackles B45 by pulling and twisting his face mask. **RULING:** Since Team B had not fouled before the change of possession, it may decline offsetting fouls and retain possession after completion of the clipping penalty.
- VII. A1 receives the snap while standing on his end line. Team B is offside at the snap. **RULING:** Team A's foul, out of bounds at the snap, offsets Team B's offside, and the down is repeated [Note: If Team B had not been offside, Team B could accept the penalty for Team A's foul or a safety (Rule 8-5-1-a)].

**Dead-Ball Fouls—ARTICLE 5****Approved Ruling 10-1-5**

- I. With fourth and eight, Team A gains four yards and the ball is declared dead, after which B1 is called for piling on. **RULING:** Team B personal foul. Penalty—15 yards from the succeeding spot. First and 10 for Team B (Rule 5-1-1-c). The clock starts on the snap.
- II. A personal foul occurs during action after a snap infraction that was made before the ball was ready for play. **RULING:** Every effort should be made to prevent any such premature snap and resulting action, but if such a foul does occur, it is between downs. Both penalties are enforced. If the personal foul is by Team B, there is likely a net of 10 yards for Team A. The penalty for Team B's foul carries an automatic first down.
- III. Second and goal at the three-yard line. Ball carrier A14 is downed at the one-yard line and then B67 piles on. A14 retaliates by punching B67. **RULING:** The penalties cancel since neither has been completed. A14 is ejected for fighting. Third and goal (Rule 10-1-1).

**Live-Ball—Dead-Ball Fouls—ARTICLE 6****Approved Ruling 10-1-6**

- I. Team A punts and is illegally in motion at the snap. The untouched ball goes out of bounds between the goal lines, after which Team B commits a personal foul. **RULING:** Possible options: (1) If Team B elects to replay the down, Team A will be penalized five yards at the previous spot followed by a 15-yard penalty against Team B, which includes an automatic first down. (2) Team B could decline the illegal-motion penalty and have the ball, first and 10 after a 15-yard penalty from the out-of-bounds spot. (3) Team B could accept the five-yard penalty enforced at the out of bounds spot (Rule 6-3-13) followed by the 15-yard penalty against Team B. In all options, the clock starts on the snap (Rule 3-3-2-d-8).
- II. Ball carrier B17 at Team A's 11-yard line taunts pursuing A55 before scoring a touchdown on an intercepted pass. After B17 crosses the goal line, he is tackled by A55 five yards into the end zone. **RULING:** Unsportsmanlike conduct by B17 and A55. Both penalties are enforced. The penalty for B17's live-ball foul is enforced at the A-11, and that for the dead-ball foul by A55 is enforced at the succeeding spot. First and 10 for Team B at the A-13.
- III. B1 fouls during a down before B2 intercepts a legal forward pass. After the ball is declared dead, A1 piles on. **RULING:** Team A retains the ball after the penalty against Team B is enforced. Team A then will be penalized for the dead-ball foul (Rule 5-2-3).
- IV. Team B is offside on the snap at its three-yard line (not a try) and Team A throws a legal forward pass into Team B's end zone. Team B intercepts and runs 101 yards to Team A's end zone, after which Team A clips. **RULING:** Repeat the down with Team A putting the ball in play at the Team B 16-1/2-yard line.
- V. No fouls have occurred when Team B intercepts Team A's legal forward pass. On the runback, a Team B player clips. When the ball becomes dead, a Team A player piles on. **RULING:** Team B retains possession. Penalize

Team B for its clipping foul, followed by a penalty for Team A's dead-ball foul. The yardages will cancel unless one enforcement spot was inside the 30-yard line and enforcement was toward that goal.

- VI. Team A punts and commits a touching violation. B1 clips during the runback of the punt, which is fumbled by B2. A1 recovers the fumble, and A2 fouls after the ball is dead. **RULING:** Team A has the first option because Team B fouled during the live ball. If Team A declines the penalty for Team B's foul, Team B will have the ball at the point of the violation, along with the option of accepting enforcement of the penalty for Team A's dead-ball foul. If Team A accepts the penalty for Team B's foul, the ball will belong to Team B after enforcement of the penalty for its live-ball foul followed by the penalty against Team A for the dead-ball foul.

## Section 2. Enforcement Procedures

### Determining the Enforcement Spot and Basic Spot—ARTICLE 2

#### Approved Ruling 10-2-2

- I. A kickoff untouched by Team B goes out of bounds after illegal touching by Team A. Team A is flagged for holding or a personal foul during the kick. **RULING:** Team B has these options: It may snap the ball at the spot of the illegal touching; accept a five-, 10- or 15-yard penalty from the previous spot with Team A re-kicking; snap the ball five, 10 or 15 yards beyond the spot where the ball went out of bounds; or snap the ball 30 yards beyond Team A's restraining line.
- II. A Team A fumble or backward pass is loose in Team A's end zone, where A33 kicks or bats the ball. **RULING:** Penalty—Safety (Rule 8-5-1-b).
- III. A55 clips in Team B's end zone during a scrimmage kick that touches B44 in the field of play. **RULING:** Penalty—15 yards. Enforcement is either at the previous spot (Team A retaining possession) or at the spot where the subsequent dead ball belongs to Team B.
- IV. Team A punts from its end zone and the ball is returned to the A-30. A23 clips B35 in Team A's end zone during the return. **RULING:** Penalty—15 yards from the basic spot, which is the end of the run (the A-30). Team B's ball, first and 10.
- V. Team A punts from its end zone and the ball is returned to the A-30 where it is fumbled. A23 clips in Team A's end zone during the fumble. The ball is recovered in the field of play. **RULING:** Penalty—15 yards from the basic spot, which is the spot of the fumble, the A-30. Team B's ball, first and 10.
- VI. Team A's untouched punt from its end zone goes out of bounds at Team A's 40-yard line. A2, in his end zone, clips Team B before the ball is kicked. **RULING:** Penalty—Safety (Rule 9-1 Penalty) or Team B may snap the ball at the Team A 25-yard line after enforcement of the penalty from where the ball went out of bounds.
- VII. Team A snaps at its one-yard line, and ball carrier A1 is downed on his five-yard line. Team B commits a personal foul in the end zone while the ball is in play. **RULING:** Penalty—15 yards from the basic spot (five-yard line).

- VIII. During a punt B1 holds A2 behind or beyond the neutral zone after the kick crosses the neutral zone and before it has touched Team B. **RULING:** Penalty—10 yards. Subject to postscrimmage kick enforcement if Team B is next to snap the ball.
- IX. During A1's run, B25 fouls 10 yards beyond the neutral zone. After advancing 30 yards, A1 fumbles. B48 recovers and carries the ball across Team A's goal line. **RULING:** Penalize Team B from the basic spot, which is the spot of the fumble. Team A retains possession of the ball (Rule 5-2-3).
- X. First and 10 at the A-30. A1 advances the ball to the B-40, where he is downed. During the run B1 clips on Team A's 45-yard line. **RULING:** Penalty—15 yards at the B-40, which is the basic spot. First and 10 at the B-25.
- XI. First and 10 at the A-40. A1 advances to the B-40, where he fumbles. During A1's run or during the fumble B2 commits a personal foul at the 50-yard line. B1 recovers the fumble and returns the ball across Team A's goal line. **RULING:** Penalty—15 yards from the basic spot, which is the end of the related run (Team B's 40-yard line) and first down for Team A.
- XII. During the return of a scrimmage kick, B40 blocks A80 in the back above the waist at the B-25. Team B's ball carrier is downed with the ball in his possession at Team B's 40-yard line. **RULING:** Team B foul, illegal block in the back. Penalty—10 yards from the spot of the foul. Team B's ball, first and 10, from its 15-yard line.
- XIII. Team B intercepts a legal forward pass, and the player who threw the pass is fouled during the return. **RULING:** Team B's ball, first down and 10, after enforcement of the penalty (Rules 2-27-5, 5-2-4 and 9-1).
- XIV. B1 intercepts a legal forward pass (not a try) deep in his end zone and is unable to get out of the end zone, where he is downed. During the run, B2 clips A1 (a) at the B-25 (b) at the B-14; (c) in the end zone. **RULING:** The basic spot is the B-20. (a) First and 10 at the B-10. (b) First and 10 at the B-7. (c) Safety. (Rules 8-5-1-b, 8-6-1 and 10-2-2-d-2-a).
- XV. B17 intercepts a legal forward pass (not a try) deep in his end zone and, as he attempts to run the ball out, A19 clips in the end zone. After the foul and before B17 leaves the end zone, B17 fumbles with A26 recovering on the two-yard line. **RULING:** Penalty—15 yards from the goal line. Team B's ball, first and 10 at its 15-yard line (Rule 10-2-2-d-2-c).
- XVI. After a safety, Team A punts the ball at Team A's 20-yard line. The ball goes out of bounds untouched by Team B. **RULING:** Team B captain has the choice of the down being repeated at the A-15, or of putting the ball in play at the 50-yard line or five yards beyond the inbounds spot.

### **Postscrimmage Kick Enforcement—ARTICLE 3**

#### **Approved Ruling 10-2-3**

- I. Either team fouls during a scrimmage kick after the ball has been touched beyond the neutral zone. The foul is beyond the neutral zone, and Team B will next put the ball in play. **RULING:** For fouls by Team B, penalty enforcement will be by the Three-and-One Principle with the postscrimmage kick spot as the basic spot (Rule 2-25-11). Team B's ball, first and 10. For fouls by Team A, penalty enforcement is either from the previous spot or from the spot where the subsequent dead ball belongs to Team B (Rule 6-3-13).

- II. Team A's punt is blocked, crosses the neutral zone and is untouched by Team B beyond the neutral zone. It rebounds behind the neutral zone before Team B clips or holds. The ball is loose at the time of the foul. **RULING:** The foul is during the kick. If Team B is next to snap the ball, enforcement is according to postscrimmage kick rules.
- III. Team A's punt is blocked behind the neutral zone before clipping or holding by Team B beyond the neutral zone. The ball never crosses the neutral zone during the play. **RULING:** Rule 10-2-3 applies only when a scrimmage kick crosses the neutral zone. Team A retains possession after the penalty is enforced at the previous spot.
- IV. Team A's successful field goal attempt is snapped at Team B's 30-yard line, and a Team B player fouls at the 20-yard line during the kick. **RULING:** Team A may decline the penalty and accept the score or void the score and have Team B penalized at the previous spot (Rule 10-2-5-d).
- V. Team A's untouched, unsuccessful field goal attempt is snapped from Team B's 30-yard line. Team B fouls at the 15-yard line during the kick. **RULING:** Team B's ball. The postscrimmage kick spot is at the 30-yard line and the enforcement is from the 15-yard line, the spot of the foul, with no possible replay (Rules 2-25-11 and 8-4-2-b).
- VI. Team A's punt crosses the neutral zone. During the kick, B79 holds A55 one yard beyond the neutral zone. B44 catches the kick at the B-25 and returns to the B-40 where he is tackled. **RULING:** B79's foul is covered by postscrimmage kick enforcement. The 10-yard penalty is enforced at the end of the kick, which is the B-25. First and 10 for Team B at the B-15.
- VII. Team A snaps the ball at the A-35 on fourth and 12. Just after the snap lineman B77 grabs guard A66 and pulls him to one side, allowing linebacker B43 to shoot the gap to try to block the kick. B44 catches the kick at the B-25 and returns to the B-40 where he is tackled. **RULING:** B77's holding foul is not covered by postscrimmage kick enforcement since it is before the kick. The 10-yard penalty is enforced at the previous spot. The penalty yardage alone does not give Team A a first down, but defensive holding includes an automatic first down. Therefore, Team A first and 10 at the A-45.

## Fouls During or After a Touchdown, Field Goal or Try—ARTICLE 5

### Approved Ruling 10-2-5

*Fouls during a touchdown or field goal by Team A:*

- I. During a touchdown run Team B clips in the field of play or the end zone. **RULING:** Team A has the option of the penalty being enforced on the try, succeeding kickoff, or from the succeeding spot in extra periods (Rule 10-2-5-a-1).
- II. Team B commits a personal foul during a down when Team A scores a touchdown, and then Team A fouls after the score and before the ready-for-play signal on the try. **RULING:** Allow the score. Team A has the option of enforcement on the try, the succeeding kickoff, or from the succeeding spot in extra periods. Team B then also has the option of Team A being penalized on the try, the succeeding kickoff, or from the succeeding spot



- in extra periods. The yardage assessed on the live-ball/dead-ball penalties may cancel (Rule 10-2-5).
- III. Team B holds during Team A's touchdown run. Team A fouls after the score. **RULING:** Allow the score. The penalty for Team B's holding foul is declined by rule. Team B has the option of Team A being penalized on the try, the succeeding kickoff, or from the succeeding spot in extra periods (Rules 10-2-5-a-2 and 10-2-5-c).
- IV. A Team B player punches an opponent during or after Team A's touchdown run. Team B is offside on the successful try. **RULING:** Allow the touchdown. Eject the Team B player for fighting. Team A has the option of a penalty against Team B on the try, the succeeding kickoff, or from the succeeding spot in extra periods. After the successful try, Team A has the option of repeating the try with the offside penalty enforced on the try (Rules 10-2-5 and 8-3-3-b).
- V. Team B roughs the passer during a touchdown pass play. **RULING:** Allow the touchdown. Team A has the option of enforcement on the try, the succeeding kickoff, or from the succeeding spot in extra periods.
- VI. Team B is offside during a successful field goal down. **RULING:** Team A has the option to accept the penalty at the previous spot and replay the down or to keep the points by declining the penalty.
- VII. Team B fouls on a successful field goal. **RULING:** Team A shall have the option of cancelling the score and have the penalty enforced from the previous spot or they may decline the penalty and accept the score. Team A may accept the score and have penalties for personal fouls and unsportsmanlike conduct enforced on the succeeding kickoff or from the succeeding spot in extra periods.

*Fouls after a touchdown by Team A:*

- VIII. Team A fouls after it scores a touchdown, and Team B fouls on the successful try. **RULING:** Allow the touchdown. Team B has the option of Team A being penalized on the try or the succeeding kickoff. Team A then has the option of Team B being penalized on a replay of the try. Team B personal-foul penalties may be enforced on the subsequent kickoff or at the succeeding spot in extra periods. Yardages assessed on the succeeding kickoff may cancel.
- IX. Team A fouls after it scores a touchdown, and Team B fouls after a successful try. **RULING:** Allow the score. Team B has the option of Team A being penalized on the try, the succeeding kickoff, or from the succeeding spot in extra periods. For the foul after the try, Team B is penalized on the kickoff or at the succeeding spot in extra periods.

*Fouls during a try with no change of team possession (this does not include live-ball fouls treated as dead-ball fouls or loss-of-down fouls):*

- X. Team B fouls during a successful try. **RULING:** Replay the down after enforcement, or the penalty is declined by rule. Penalties for personal fouls and unsportsmanlike conduct fouls may be enforced on the succeeding kickoff or at the succeeding spot in extra periods (Rule 8-3-3-b-1).
- XI. Team B fouls during a successful try. **RULING:** Replay the down after enforcement, or the penalty is declined by rule. Penalties for personal fouls

may be enforced on the succeeding kickoff or at the succeeding spot in extra periods (Rule 8-3-3-b-1).

- XII. During a successful kick try from the three-yard line, Team B is offside. After the ball is dead, Team B commits a personal foul. **RULING:** If Team A elects to replay the try, both penalties against Team B are enforced before the snap (Rule 10-1-6). If Team A declines the offside penalty and accepts the point, the penalty for Team B's dead-ball foul is then enforced on the kickoff or at the succeeding spot in extra periods. (Rule 8-3-5)
- XIII. During an unsuccessful kick try from the three-yard line, Team A commits an illegal-motion foul. After the ball becomes dead, Team B fouls. **RULING:** Team B obviously will refuse the penalty for the Team A foul. Team B is penalized on the kickoff or at the succeeding spot in extra periods.
- Fouls after a try and before the succeeding kickoff:*
- XIV. Either team fouls. **RULING:** Enforce the penalty on the kickoff unless the try is the last down of the game.
- XV. Both teams foul before either penalty is completed. **RULING:** The fouls cancel.
- XVI. The penalty for Team B's foul after a successful try is accepted and will be enforced on the free kick; then:
1. Team A fouls after the try. **RULING:** Enforce the penalties in occurrence order on the kickoff or at the succeeding spot in extra periods.
  2. Team B fouls after the try. **RULING:** Enforce both Team B penalties in occurrence order on the kickoff or at the succeeding spot in extra periods.
  3. Both teams foul before either penalty is completed. **RULING:** These fouls cancel. The penalty for Team B's original foul is enforced on the kickoff or at the succeeding spot in extra periods.

# Index to Rules

Term	Page	Term	Page
<b>A</b>		<b>A</b>	
Administrative rules .....	<a href="#">FR-13</a>	Clock, game .....	<a href="#">FR-50</a>
Advance of, defined .....	<a href="#">FR-32</a>	Clock, when started .....	<a href="#">FR-52</a>
Advertising		Clock, when stopped .....	<a href="#">FR-52</a>
Prohibited on Down Indicators .....	<a href="#">FR-18</a>	Coaches' certification .....	<a href="#">FR-25</a>
Prohibited on Goals .....	<a href="#">FR-17</a>	Coaching box .....	<a href="#">FR-16</a>
Approved Rulings .....	<a href="#">FR-28</a>	Color of ball .....	<a href="#">FR-19</a>
<b>B</b>		Color of gloves .....	<a href="#">FR-24</a>
Back, Defined .....	<a href="#">FR-41</a>	Completed pass .....	<a href="#">FR-82</a>
Backward, defined .....	<a href="#">FR-32</a>	Concealing ball .....	<a href="#">FR-101</a>
Backward pass		Conduct of players and others .....	<a href="#">FR-92</a>
Caught in flight .....	<a href="#">FR-80</a>	Conduct rules .....	<a href="#">FR-13</a>
Defined .....	<a href="#">FR-37</a>	Conference, head coach's .....	<a href="#">FR-54</a>
Out of bounds .....	<a href="#">FR-80</a>	Continuity of downs .....	<a href="#">FR-65</a>
Recovered on ground .....	<a href="#">FR-80</a>	<b>D</b>	
Ball		Darkness .....	<a href="#">FR-49</a>
Change of .....	<a href="#">FR-19</a>	Dead ball	
Drying .....	<a href="#">FR-19</a>	Becomes alive .....	<a href="#">FR-61</a>
Marking .....	<a href="#">FR-20</a>	Declared .....	<a href="#">FR-61</a>
Return to official .....	<a href="#">FR-100</a>	Defined .....	<a href="#">FR-28</a>
Specifications .....	<a href="#">FR-19</a>	Dead-ball spot .....	<a href="#">FR-39</a>
Ball carrier .....	<a href="#">FR-42</a>	Declining penalties .....	<a href="#">FR-108</a>
Basic spot .....	<a href="#">FR-40</a>	Defenseless player, targeting .....	<a href="#">FR-93</a>
Batting		Defensive team	
Backward pass .....	<a href="#">FR-106</a>	Defined .....	<a href="#">FR-41</a>
Ball in possession .....	<a href="#">FR-106</a>	Requirements .....	<a href="#">FR-78</a>
Defined .....	<a href="#">FR-33</a>	Definitions .....	<a href="#">FR-28</a>
Loose ball .....	<a href="#">FR-105</a>	Delaying a half .....	<a href="#">FR-57</a>
Behind, defined .....	<a href="#">FR-32</a>	Delay of game .....	<a href="#">FR-57</a>
Belongs to, defined .....	<a href="#">FR-30</a>	Deliberately advancing	
Beyond, defined .....	<a href="#">FR-32</a>	Defined (2–5) .....	<a href="#">FR-31</a>
Bleeding players .....	<a href="#">FR-55</a>	Prohibited (3–4) .....	<a href="#">FR-57</a>
Blind-side block		Disconcerting opponents .....	<a href="#">FR-79</a>
Defined .....	<a href="#">FR-29</a>	Disqualified player .....	<a href="#">FR-42</a>
Foul .....	<a href="#">FR-99</a>	Disqualifying fouls .....	<a href="#">FR-92</a>
Blocking		Distance gained .....	<a href="#">FR-64</a>
Defined .....	<a href="#">FR-29</a>	Down	
Use of Hands/Arms .....	<a href="#">FR-103</a>	Defined (2–6) .....	<a href="#">FR-31</a>
Blocking below waist		When ended (2–6) .....	<a href="#">FR-31</a>
Defined .....	<a href="#">FR-29</a>	When started (2–6) .....	<a href="#">FR-31</a>
Defined (2–3) .....	<a href="#">FR-29</a>	Down after a foul .....	<a href="#">FR-65</a>
Blocking scrimmage kick .....	<a href="#">FR-33</a>	Drop kick .....	<a href="#">FR-35</a>
Block in the back		<b>E</b>	
Defined .....	<a href="#">FR-29</a>	Ejected player .....	<a href="#">FR-43</a>
Prohibited .....	<a href="#">FR-105</a>	Eligible to catch	
<b>C</b>		Backward pass .....	<a href="#">FR-79</a>
Captains, team .....	<a href="#">FR-14</a>	Free kick .....	<a href="#">FR-68</a>
Catch .....	<a href="#">FR-30</a>	Fumble .....	<a href="#">FR-80</a>
Catchable forward pass .....	<a href="#">FR-38</a>	Illegal pass .....	<a href="#">FR-81</a>
Charged timeouts		Legal pass .....	<a href="#">FR-81</a>
Length .....	<a href="#">FR-55</a>	Scrimmage kick .....	<a href="#">FR-70</a>
Must be granted .....	<a href="#">FR-54</a>	Encroachment .....	<a href="#">FR-37</a>
Notice to coach .....	<a href="#">FR-54</a>	End lines .....	<a href="#">FR-34</a>
30-second warning .....	<a href="#">FR-56</a>	End zones .....	<a href="#">FR-45</a>
Chop block		Enforcement spot .....	<a href="#">FR-39</a>
Defined .....	<a href="#">FR-29</a>	Equipment, player	
Prohibited .....	<a href="#">FR-97</a>	Enforcement .....	<a href="#">FR-25</a>
Clipping		Illegal .....	<a href="#">FR-25</a>
Defined .....	<a href="#">FR-31</a>	Mandatory .....	<a href="#">FR-21</a>
Prohibited .....	<a href="#">FR-95</a>	Repairs, replacement .....	<a href="#">FR-24</a>

Term	Page	Term	Page
<b>F</b>			
Face mask		Illegally touched.....	<a href="#">FR-68</a>
Defined .....	<a href="#">FR-21</a>	Out of bounds.....	<a href="#">FR-70</a>
Grasping .....	<a href="#">FR-96</a>	Restraining lines.....	<a href="#">FR-67</a>
Striking.....	<a href="#">FR-92</a>	Where kicked.....	<a href="#">FR-67</a>
Fair catch		Who may recover.....	<a href="#">FR-68</a>
Defined .....	<a href="#">FR-31</a>	Fumble	
Kicked .....	<a href="#">FR-73</a>	Caught in flight .....	<a href="#">FR-80</a>
Signals .....	<a href="#">FR-31</a>	Defined .....	<a href="#">FR-33</a>
False start.....	<a href="#">FR-76</a>	Out of bounds.....	<a href="#">FR-80</a>
Feigning a charge.....	<a href="#">FR-77</a>	Recovered on ground.....	<a href="#">FR-80</a>
Field areas		Who may recover.....	<a href="#">FR-80</a>
End zones.....	<a href="#">FR-45</a>	<b>G</b>	
Field of play .....	<a href="#">FR-45</a>	Game, description .....	<a href="#">FR-14</a>
Field, the.....	<a href="#">FR-45</a>	Gloves, defined .....	<a href="#">FR-24</a>
Playing enclosure.....	<a href="#">FR-45</a>	Goal	
Playing surface.....	<a href="#">FR-45</a>	Choice of .....	<a href="#">FR-47</a>
Field equipment, prohibited .....	<a href="#">FR-25</a>	Defined .....	<a href="#">FR-17</a>
Field goal		Goal lines	
Defined .....	<a href="#">FR-36</a>	Defined .....	<a href="#">FR-33</a>
Next play .....	<a href="#">FR-89</a>	Location .....	<a href="#">FR-14</a>
Scoring value.....	<a href="#">FR-86</a>	<b>H</b>	
Unsuccessful .....	<a href="#">FR-89</a>	Handing ball forward	
When scored .....	<a href="#">FR-88</a>	Behind line.....	<a href="#">FR-79</a>
Field of play.....	<a href="#">FR-45</a>	Beyond line.....	<a href="#">FR-79</a>
Field, the		Defined .....	<a href="#">FR-34</a>
Dimensions.....	<a href="#">FR-15</a>	Hands and arms, use of	
Markings .....	<a href="#">FR-15</a>	When ball is in possession .....	<a href="#">FR-104</a>
Surface .....	<a href="#">FR-18</a>	Hash marks .....	<a href="#">FR-34</a>
Fighting		Helmet, initiating contact with.....	<a href="#">FR-93</a>
Defined .....	<a href="#">FR-45</a>	Helping runner.....	<a href="#">FR-103</a>
Penalty.....	<a href="#">FR-106</a>	Holder .....	<a href="#">FR-41</a>
Fist, striking with.....	<a href="#">FR-93</a>	Holding	
Formation, free kick.....	<a href="#">FR-67</a>	Defense .....	<a href="#">FR-105</a>
Formation, scrimmage.....	<a href="#">FR-77</a>	Offense .....	<a href="#">FR-104</a>
Forward pass		Horse-collar tackle.....	<a href="#">FR-98</a>
Catchable.....	<a href="#">FR-38</a>	Huddle .....	<a href="#">FR-34</a>
Completed.....	<a href="#">FR-82</a>	Hurdling .....	<a href="#">FR-35</a>
Crosses neutral zone.....	<a href="#">FR-38</a>	<b>I</b>	
Defined .....	<a href="#">FR-37</a>	Illegal pass .....	<a href="#">FR-81</a>
Eligibility regained .....	<a href="#">FR-82</a>	Illegal use of hands and arms	
Eligible receivers .....	<a href="#">FR-81</a>	When ball is in possession .....	<a href="#">FR-104</a>
Grounded.....	<a href="#">FR-81</a>	Impetus.....	<a href="#">FR-91</a>
Illegal.....	<a href="#">FR-81</a>	Inbounds lines .....	<a href="#">FR-33</a>
Illegal contact.....	<a href="#">FR-82</a>	Inbounds spot.....	<a href="#">FR-40</a>
Illegally touched.....	<a href="#">FR-82</a>	Incomplete pass .....	<a href="#">FR-82</a>
Incomplete.....	<a href="#">FR-82</a>	Injury timeouts.....	<a href="#">FR-54</a>
Ineligible receivers.....	<a href="#">FR-81</a>	Instant replay.....	<a href="#">FR-113</a>
Ineligibles downfield .....	<a href="#">FR-84</a>	Interception.....	<a href="#">FR-30</a>
Interference.....	<a href="#">FR-82</a>	Interference	
Legal.....	<a href="#">FR-81</a>	In neutral zone.....	<a href="#">FR-78</a>
Forward point, ball's .....	<a href="#">FR-63</a>	With ball .....	<a href="#">FR-79</a>
Forward progress		With opportunity to catch kick.....	<a href="#">FR-73</a>
Defined .....	<a href="#">FR-32</a>	With pass.....	<a href="#">FR-82</a>
Line to Gain.....	<a href="#">FR-64</a>	Interlocked interference.....	<a href="#">FR-103</a>
Fouls		Intermissions	
By same team (10-1).....	<a href="#">FR-108</a>	Between halves.....	<a href="#">FR-49</a>
Defined .....	<a href="#">FR-32</a>	Between periods .....	<a href="#">FR-49</a>
Offsetting.....	<a href="#">FR-108</a>	Collegiate games .....	<a href="#">FR-49</a>
When penalized .....	<a href="#">FR-108</a>	<b>J</b>	
When reported.....	<a href="#">FR-108</a>	Jersey.....	<a href="#">FR-22</a>
Free kicks			
At rest .....	<a href="#">FR-68</a>		
Defined .....	<a href="#">FR-35</a>		
Forced touching.....	<a href="#">FR-68</a>		
Formation.....	<a href="#">FR-67</a>		

Term	Page	Term	Page
<b>K</b>			
Kick, defined.....	<a href="#">FR-35</a>	Periods	
Kicker, the.....	<a href="#">FR-41</a>	Extending.....	<a href="#">FR-50</a>
Kicking a player.....	<a href="#">FR-93</a>	Extra.....	<a href="#">FR-48</a>
Kicking ball, illegally.....	<a href="#">FR-106</a>	How started.....	<a href="#">FR-47</a>
Kickoff.....	<a href="#">FR-36</a>	Personal fouls.....	<a href="#">FR-92</a>
Kicks, legal and illegal.....	<a href="#">FR-35</a>	Persons subject to rules.....	<a href="#">FR-14</a>
Kneeing.....	<a href="#">FR-92</a>	Phones, coaches'.....	<a href="#">FR-26</a>
<b>L</b>			
Language, usage.....	<a href="#">FR-99</a>	Piling on.....	<a href="#">FR-96</a>
Leaping.....	<a href="#">FR-97</a>	Place kicks.....	<a href="#">FR-35</a>
Legal forward pass.....	<a href="#">FR-81</a>	Play classification	
Length of game, Collegiate.....	<a href="#">FR-49</a>	Forward pass.....	<a href="#">FR-44</a>
Limit lines.....	<a href="#">FR-16</a>	Free kick.....	<a href="#">FR-44</a>
Lineman		Running play.....	<a href="#">FR-44</a>
Defined.....	<a href="#">FR-41</a>	Scrimmage kick.....	<a href="#">FR-44</a>
Interior.....	<a href="#">FR-41</a>	Play-clock count.....	<a href="#">FR-62</a>
Line to gain		Player	
Defined.....	<a href="#">FR-64</a>	Airborne.....	<a href="#">FR-42</a>
Line to gain Indicator.....	<a href="#">FR-18</a>	Defined.....	<a href="#">FR-42</a>
Live ball.....	<a href="#">FR-28</a>	Departing.....	<a href="#">FR-42</a>
Live ball becomes dead.....	<a href="#">FR-61</a>	Replaced.....	<a href="#">FR-42</a>
Loose ball		Vacancy.....	<a href="#">FR-42</a>
Defined.....	<a href="#">FR-28</a>	Players, by position.....	<a href="#">FR-20</a>
Planned.....	<a href="#">FR-79</a>	Playing time	
Loss of a down.....	<a href="#">FR-31</a>	Adjustments (3-2).....	<a href="#">FR-49</a>
<b>M</b>			
Markers.....	<a href="#">FR-18</a>	Extended (3-2).....	<a href="#">FR-50</a>
Measure to ball's forward point.....	<a href="#">FR-64</a>	For game (3-2).....	<a href="#">FR-49</a>
Medical observer.....	<a href="#">FR-116</a>	How kept (3-2).....	<a href="#">FR-50</a>
Meeting with knee.....	<a href="#">FR-93</a>	Shortened (3-2).....	<a href="#">FR-49</a>
Motion, illegal.....	<a href="#">FR-76</a>	Points of Emphasis.....	<a href="#">FR-7</a>
Muff.....	<a href="#">FR-33</a>	Possession after penalty.....	<a href="#">FR-65</a>
<b>N</b>			
Neutral zone.....	<a href="#">FR-37</a>	Possession of ball.....	<a href="#">FR-28</a>
Nine-yard marks.....	<a href="#">FR-34</a>	Postscrimmage kick spot.....	<a href="#">FR-40</a>
Numbering, players'.....	<a href="#">FR-20</a>	Pregame warm-up.....	<a href="#">FR-47</a>
Number of players.....	<a href="#">FR-14</a>	Previous spot.....	<a href="#">FR-39</a>
<b>O</b>			
Obstructions.....	<a href="#">FR-18</a>	Punt.....	<a href="#">FR-35</a>
Offensive team		Putting ball in play	
Defined.....	<a href="#">FR-41</a>	After field goal.....	<a href="#">FR-89</a>
Requirements.....	<a href="#">FR-77</a>	After foul.....	<a href="#">FR-52</a>
Officials		After touchback.....	<a href="#">FR-90</a>
Duties and jurisdiction.....	<a href="#">FR-112</a>	After try.....	<a href="#">FR-88</a>
Offside.....	<a href="#">FR-37</a>	After unsuccessful field goal.....	<a href="#">FR-89</a>
Out of bounds		Before being ready.....	<a href="#">FR-61</a>
Ball.....	<a href="#">FR-63</a>	Defined.....	<a href="#">FR-62</a>
Forward point.....	<a href="#">FR-63</a>	Pylons.....	<a href="#">FR-17</a>
Held ball.....	<a href="#">FR-63</a>	<b>R</b>	
Player.....	<a href="#">FR-63</a>	Ready for play	
Out-of-bounds lines.....	<a href="#">FR-33</a>	Ball is.....	<a href="#">FR-28</a>
Out-of-bounds spot.....	<a href="#">FR-40</a>	Play clock.....	<a href="#">FR-50</a>
<b>P</b>			
Passer, the.....	<a href="#">FR-42</a>	Recovered, defined.....	<a href="#">FR-30</a>
Passes, defined.....	<a href="#">FR-37</a>	Restraining lines	
Penalties		(2-12).....	<a href="#">FR-34</a>
Completed.....	<a href="#">FR-108</a>	(6-1).....	<a href="#">FR-67</a>
Declined.....	<a href="#">FR-66</a> , <a href="#">FR-108</a>	Return kick.....	<a href="#">FR-36</a>
Defined.....	<a href="#">FR-38</a>	Roughing or running into the kicker or holder.....	<a href="#">FR-98</a>
Summary of.....	<a href="#">FR-141</a>	Roughing passer.....	<a href="#">FR-96</a>
<b>R</b>			
Passer, the.....	<a href="#">FR-42</a>	Running into opponent.....	<a href="#">FR-98</a>
Passes, defined.....	<a href="#">FR-37</a>	<b>S</b>	
Penalties		Safety	
Completed.....	<a href="#">FR-108</a>	Defined.....	<a href="#">FR-89</a>
Declined.....	<a href="#">FR-66</a> , <a href="#">FR-108</a>	Initial impetus.....	<a href="#">FR-91</a>
Defined.....	<a href="#">FR-38</a>	Next play.....	<a href="#">FR-90</a>
Summary of.....	<a href="#">FR-141</a>	Responsibility.....	<a href="#">FR-90</a>
<b>S</b>			
Passer, the.....	<a href="#">FR-42</a>	Scoring value.....	<a href="#">FR-86</a>
Passes, defined.....	<a href="#">FR-37</a>		

Term	Page	Term	Page
Score, referee sole authority .....	<a href="#">FR-112</a>	<b>T</b>	
Scoring, extra periods .....	<a href="#">FR-48</a>	Tackling.....	<a href="#">FR-41</a>
Scoring values		Targeting.....	<a href="#">FR-93</a>
Field goal .....	<a href="#">FR-86</a>	Team area .....	<a href="#">FR-16</a>
Safety.....	<a href="#">FR-86</a>	Team A; Team B .....	<a href="#">FR-41</a>
Touchdown .....	<a href="#">FR-86</a>	Tee.....	<a href="#">FR-35</a>
Try.....	<a href="#">FR-86</a>	Ten-second runoff.....	<a href="#">FR-59</a>
Scrimmage		Tiebreaker system .....	<a href="#">FR-48</a>
Defined .....	<a href="#">FR-38</a>	Timeouts	
Formation.....	<a href="#">FR-77</a>	Always charged.....	<a href="#">FR-51</a>
How started .....	<a href="#">FR-76</a>	Charged team .....	<a href="#">FR-51</a>
Not outside an inbounds line .....	<a href="#">FR-76</a>	Extra-period .....	<a href="#">FR-48</a>
Scrimmage kick		Injury.....	<a href="#">FR-54</a>
Batting behind goal line .....	<a href="#">FR-72</a>	Length.....	<a href="#">FR-55</a>
Behind goal line.....	<a href="#">FR-71</a>	Limitations (number) .....	<a href="#">FR-54</a>
Behind neutral zone.....	<a href="#">FR-70</a>	Notice to coach .....	<a href="#">FR-56</a>
Beyond neutral zone.....	<a href="#">FR-70</a>	Player's .....	<a href="#">FR-54</a>
Blocked.....	<a href="#">FR-33</a>	Referee's .....	<a href="#">FR-53</a>
Caught or recovered .....	<a href="#">FR-71</a>	When declared .....	<a href="#">FR-51</a>
Defined .....	<a href="#">FR-36</a>	Timing devices	
Forced touching of .....	<a href="#">FR-71</a>	Game clock .....	<a href="#">FR-44</a>
Illegally touched.....	<a href="#">FR-71</a>	Play clock .....	<a href="#">FR-44</a>
Legal, illegal.....	<a href="#">FR-71</a>	Tobacco, use of .....	<a href="#">FR-103</a>
Out of bounds.....	<a href="#">FR-71</a>	Toss of coin .....	<a href="#">FR-47</a>
Postscrimmage kick .....	<a href="#">FR-110</a>	Touchback	
Scrimmage line.....	<a href="#">FR-38</a>	Defined .....	<a href="#">FR-90</a>
Selection of ball.....	<a href="#">FR-19</a>	Initial impetus.....	<a href="#">FR-91</a>
Series of downs		Next play.....	<a href="#">FR-90</a>
Continuity of downs.....	<a href="#">FR-65</a>	Responsibility .....	<a href="#">FR-90</a>
When awarded .....	<a href="#">FR-64</a>	Touchdown	
Shift, defined .....	<a href="#">FR-38</a>	Defined .....	<a href="#">FR-86</a>
Shift, one-second pause.....	<a href="#">FR-76</a>	Next play.....	<a href="#">FR-86</a>
Sidelines .....	<a href="#">FR-15</a>	Scoring value.....	<a href="#">FR-86</a>
Signal devices, prohibited .....	<a href="#">FR-25</a>	Touchdown Touching, defined .....	<a href="#">FR-33</a>
Simultaneous catch or recovery.....	<a href="#">FR-31</a>	Tripping	
Snap; snapping		Defined .....	<a href="#">FR-44</a>
Ball must be still .....	<a href="#">FR-76</a>	Violation .....	<a href="#">FR-92</a>
Defined .....	<a href="#">FR-38</a>	Try	
Who may receive .....	<a href="#">FR-76</a>	Defined .....	<a href="#">FR-86</a>
Snapper, position.....	<a href="#">FR-77</a>	Next play.....	<a href="#">FR-88</a>
Snapper, the.....	<a href="#">FR-42</a>	Replays .....	<a href="#">FR-88</a>
Spot		Scoring value.....	<a href="#">FR-86</a>
Of foul.....	<a href="#">FR-39</a>	<b>U</b>	
Where kick ends.....	<a href="#">FR-40</a>	Unfair game-clock tactics .....	<a href="#">FR-57</a>
Where run ends.....	<a href="#">FR-40</a>	Unsportsmanlike conduct.....	<a href="#">FR-99</a>
Spots .....	<a href="#">FR-39</a>	<b>V</b>	
Squad member .....	<a href="#">FR-43</a>	Violation, defined .....	<a href="#">FR-32</a>
Striking with		<b>W</b>	
Foot or lower leg .....	<a href="#">FR-93</a>	When-in-question rules .....	<a href="#">FR-144</a>
Locked hands, elbows .....	<a href="#">FR-93</a>	Winning team .....	<a href="#">FR-14</a>
Side, back, heel of hand .....	<a href="#">FR-93</a>	<b>Y</b>	
Subject to rules.....	<a href="#">FR-92</a>	Yardage chain and down	
Substitute, defined.....	<a href="#">FR-42</a>	Ground marker .....	<a href="#">FR-18</a>
Substitutions		Indicator .....	<a href="#">FR-18</a>
Legal (3-5) .....	<a href="#">FR-59</a>	Yard line, defined.....	<a href="#">FR-34</a>
Procedures (3-5) .....	<a href="#">FR-59</a>		
Restrictions (3-5) .....	<a href="#">FR-59</a>		
Succeeding spot.....	<a href="#">FR-39</a>		
Summary of Penalties .....	<a href="#">FR-141</a>		
Supervision of game.....	<a href="#">FR-14</a>		
Suspension of game.....	<a href="#">FR-53</a>		

# The NCAA has various formats of the NCAA Rules Books for your computer, phone and tablets.

Available at [www.ncaapublications.com](http://www.ncaapublications.com).

The flexible-layout format allows readers to choose the best reading experience for **ANY** device or environment. The electronic versions also feature a fully hyperlinked index.

## Enhanced PDF download

The latest PDF NCAA Rules Books editions also contain interactive features, such as a hyperlinked index and table of contents. Major rules changes and points of emphasis, where applicable, are also hyperlinked. Of course, you can also use the PDF search capabilities to locate all instances of a particular word or term.

## Inclusive Distribution and Display of ePubs

Download your NCAA Rules Books Reader Guide (PDF instructions on [www.ncaapublications.com](http://www.ncaapublications.com) on the page of each rules book) for the latest tips on displaying the (ePub) download on your iPhone, Samsung, iPad, Kindle, Nook, desktop and browser. The guide also has tips for best experiences on the interactive PDF. All ePub downloads meet the guidelines of the NCAA Inclusion Forum regarding equal accessibility.

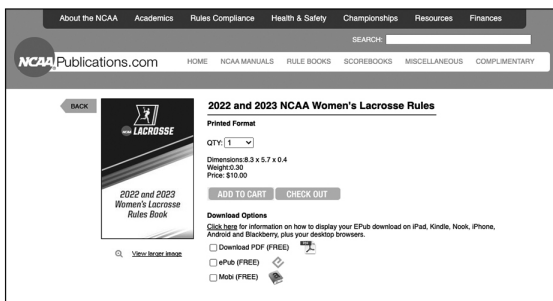

On [www.ncaapublications.com](http://www.ncaapublications.com), go to the rules book you want, and choose the format you want from the available links. Click the appropriate box to begin the download of the latest electronic version of your chosen book. Each mobile device will require installation of the appropriate application for reading your book on a tablet or phone. Consult your device or app manufacturer for which mobile version (mobi or ePub) format is compatible with your required application.



**FR22**

NCAA is a trademark of the National Collegiate Athletic Association.